

MAY 2020
REV 01

iGas Detector CO₂

Portable Single Gas Detector



User's Manual

SENKO

Product Overview

The iGas Detector CO₂ is a portable single gas detector designed to detect the presence of carbon dioxide gas in ambient environment. When activated, iGas Detector CO₂ continuously monitors ambient air for the presence of carbon dioxide gas and alerts the user to potentially unsafe exposure with LED, vibrating, and audible alarms in the event that gas concentration exceeds alarm setpoints. The settings value can be adjusted manually or by connecting to a PC software.

WARNING

- Any unauthorized attempt to repair or modify the product, or any other cause of damage beyond the range of the intended use, including damage by fire, lightning, or other hazard, voids liability of the manufacturer.
- Activate this product only if sensor, visual, detection, and audible cover are clear from contaminants such as dirt and debris that could block the area where gas is to be detected.
- Do not clean and rub the LCD screen of the products with a dry cloth or hands in hazardous environment to prevent the static electricity.
- Perform cleaning and maintenance of the products in fresh air that is free of hazardous gases
- Test the response of a sensor regularly by the gas concentration exceeding alarm set points.
- Test LED, audio and vibration manually.
- If the temperature changes sharply during use of the device (e.g., indoors vs outdoors), the value of the measured gas concentration can suddenly change. Please use the detector after the gas concentration value has stabilized.
- Severe vibration or shock to the device may cause a sudden reading change. Please use detector after the value of gas concentration has stabilized. Excessive shock to the detector can cause the device and/or sensor to malfunction.
- Alarm value should be set based on the international standard. Therefore, alarm values should be changed only under the responsibility and approval of the administration of the work site where the instrument is used.
- Use IR communications in the safety zone which is free of hazardous gases.
- Replace the battery and sensor in clean environment, which is free of hazardous gas.
- If the CO₂ concentration reaches 0ppm, the calibration should be performed.

CAUTION

- Before operating this device, please read the manual carefully.
- This device is not a analyzer, but a gas detector.
- If calibration and self-test fails continuously, please do not use the device.
- Clean detectors with a soft cloth and do not use chemical substances for cleaning.

Table Contents

1. LCD and Part Description	4
2. Activation & Deactivation	5
2.1. Bump test	
3. Mode	6
3.1. Measuring Mode	
3.2. Display Mode	
3.3. Menu Tree	7
4. Setting Mode	8
4.1. Alarm & Adjust alarm setpoints	9
4.2. Calibration	10
4.3. Clr max	11
4.4. Clr STEL and TWA	12
4.5. Adjust Unit	
4.6. Factory Reset	
4.7. Self Test	
5. Software Manager	13
6. Maintenance	16
7. Specification	17
8. Warranty	18

1. LCD and Part Description

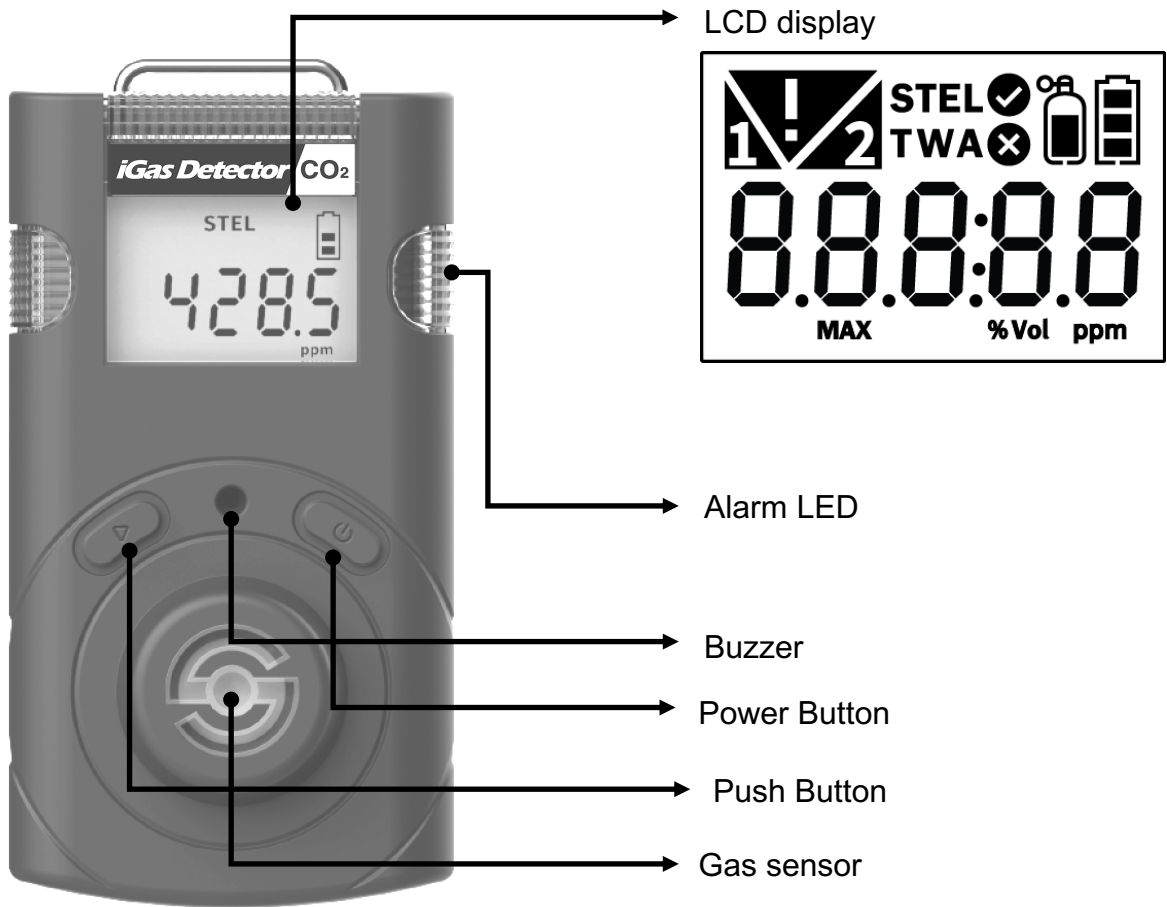

Part Description

	Calibration / Setting Success		Calibration / Setting Failure
%Vol ppm	Measurement Unit		Standard Gas Calibration
	Remaining Battery		1 st Alarm Display
	2 nd Alarm Display		Alarm Condition
MAX	Max Peak Value	STEL TWA	Short Term Exposure Limit Time Weighted Average
	Test Success		Test Fail

2. Activation & Deactivation

1. Move to a fresh air environment, which is free of hazardous gas
2. Press and hold down the Power button for approximately 2 seconds until the gas type (CO₂) is displayed.
3. Upon activation, gas type(CO₂), firmware version, and display appears, and the detector performs the self diagnostic test.
4. After self test is successful, the detector countdown is displayed for 10 seconds.
5. The detector displays current CO₂ concentration.

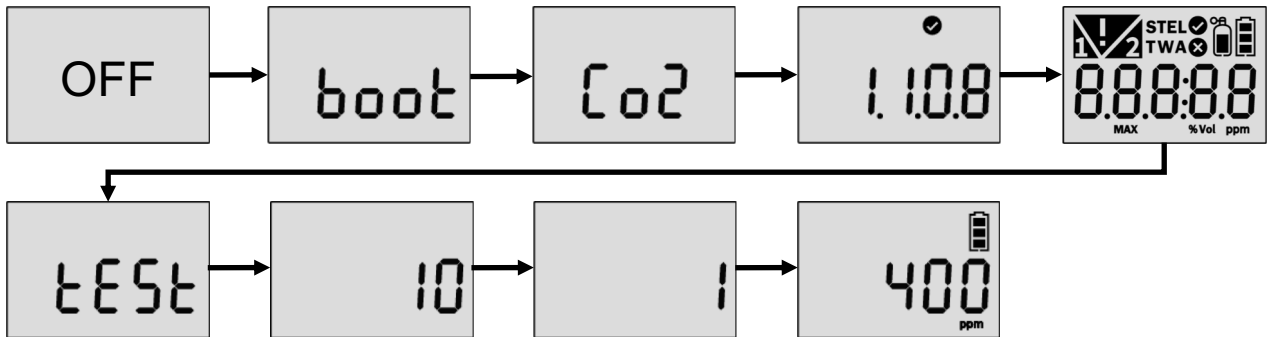

If the stabilization is failed, Error mark is displayed and measuring mode will not be entered. In this case, contact authorized resellers or SENKO service center at 82-31-492-0445 for repair or return.

Err marks

Err-1	Initial setting error
Err-2	Sensor error
Err-3	Memory error
L-bat	Low battery

2.1. Bump test

1. Before daily use, users are required to perform bump test to see a sensor responds to a CO₂ gas.
2. To perform the bump test, follow the below steps.
 - Prepare a CO₂ gas over low and high alarm.
 - Press and hold the Push button and Power button for three seconds in the measurement mode. Press the Push button until "TEST" is displayed and press the power button to enter the mode.
 - Press the Push button until "BTS" is displayed and press the Power button to activate it.
 - After pressing the Power button, apply a CO₂ gas over low and first alarm and the 30 seconds count down is displayed.
 - Once the test is passed, "SUC"(V) icon appears on the display. If test is failed, "FA"*(X) mark appears on the display.

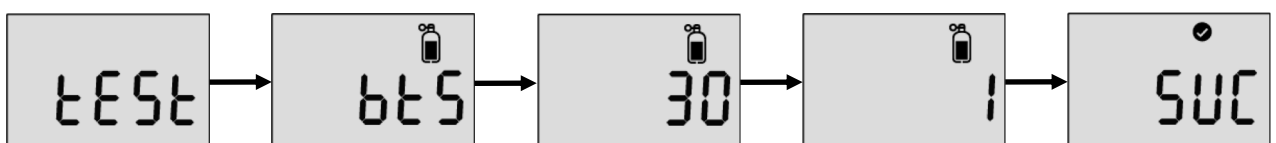

3. Mode

3.1. Measuring mode











When activated, in Measuring mode, gas concentration is displayed.

3.2. Display mode

In the measuring mode, by pressing Push button, the following ICONS will appear in order. Max value -> STEL value -> TWA value -> 1st alarm setpoint -> 2nd alarm setpoint -> STEL alarm setpoint -> TWA alarm setpoint -> Firmware version -> Calibration concentration

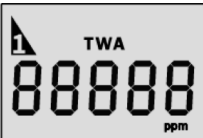
- To move to the next menu, press the Push button.
- At the last step, press Push button or do not push any button for 10 seconds, the device will return to the Measuring Mode.

	Maximum Peak Value		Measured SETL value
	Measured TWA value		Low Alarm Value Setting
	High Alarm Value Setting		STEL Alarm Value Setting
	TWA Alarm Value Setting		Firmware version
	Calibration Concentration		

3. Mode

3.3. Menu Tree

⏻ 2 sec Power and Enter Button

▷ Push Button

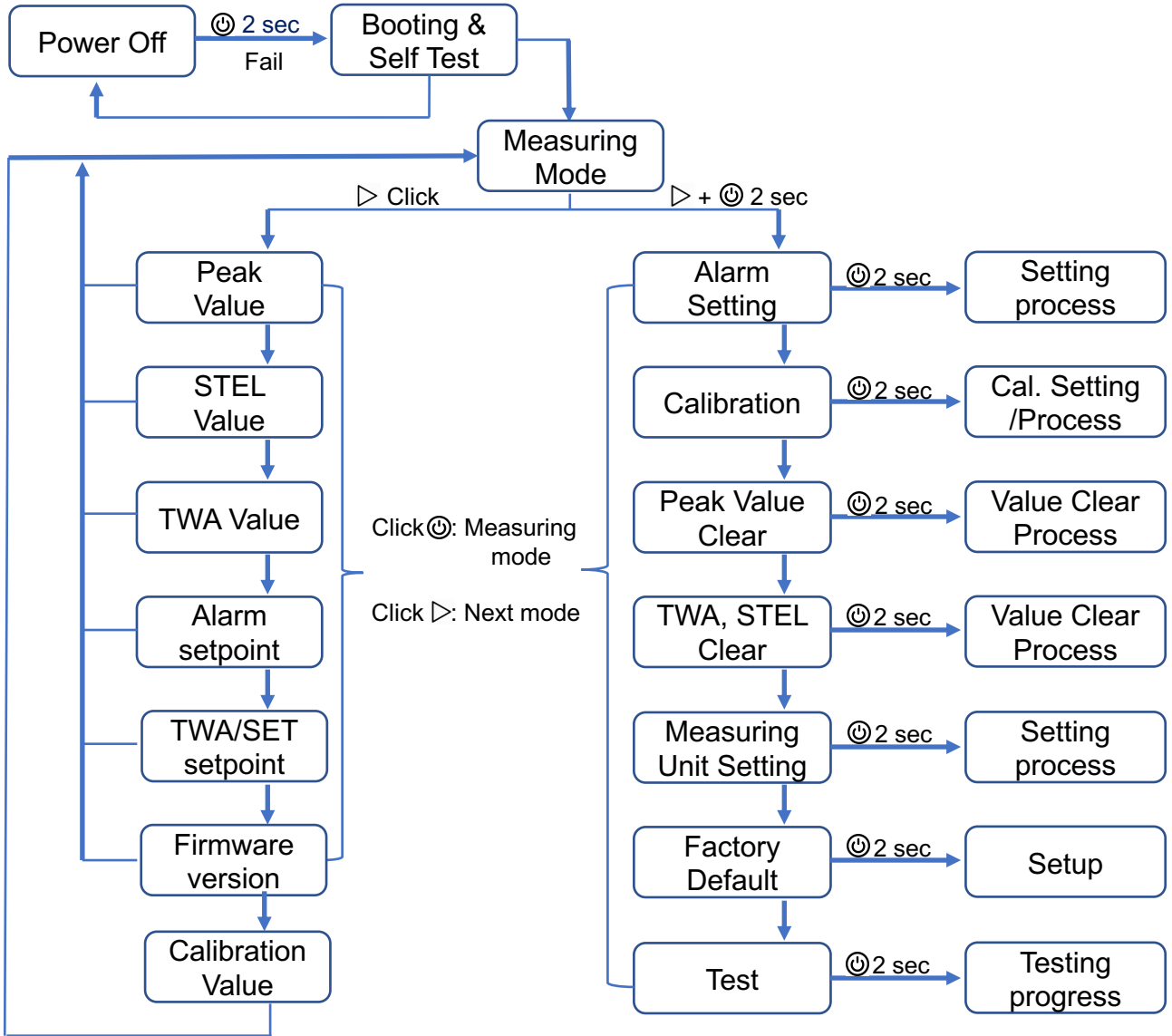

CAUTION

- Clicking the Key button (⏻) during the any mode, will automatically return to the Measuring Mode. To enter to the mode, click and hold the Key Button (⏻) for 2 seconds.





4. Setting Mode

In the setting mode, users can adjust setpoints, perform calibration, and reset previous values.

1. To enter the setting mode, press and hold the Push button & power button simultaneously for three seconds. The following menu ALr → CAL → Clr MAX → Clr STEL, TWA → Unit → Init → Test is displayed.
2. To move the next menu, press the Push button.
3. To enter the menu, press and hold down the power button.



*Alarm setpoints, TWA, STEL can be adjusted in the setting mode.

Setting Mode Symbols

Setting	Submenu	LCD	Action
ALr	1 st Alarm 2 nd Alarm		1 st alarm concentration setting 2 nd alarm concentration setting
CAL	Fresh N2 Co2		Fresh air Calibration N2 Calibration Co2 Calibration
Clr MAX	-		Delete maximum alarm Concentration
Clr STEL, TWA	-		Delete maximum STEL and TWA concentration
Unit	%vol / ppm	-	Concentration unit conversion
Init	-	-	Reset
Test	Self Bts	-	Self-test Bump test

4. Setting Mode

4.1. Alarm Activation & Adjust alarm setpoints

When the gas concentration exceeds alarm set points,  or  will be displayed and the device will vibrate, flash (LED), and beep. To remove alarms, move to a clean air location. When a gas concentration is decreased below the alarm setpoints, alarm will stop.



Low Alarm

- Audible Alarm: 3 beeps per seconds
- LED: 3 flashes per seconds
- Vibration: 1 vibration per second

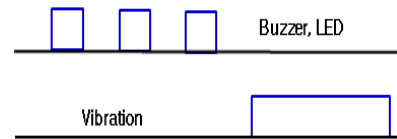

High Alarm

- Audible Alarm: 4 beeps per seconds
- LED: 4 flashes per seconds
- Vibration: 1 vibration per second

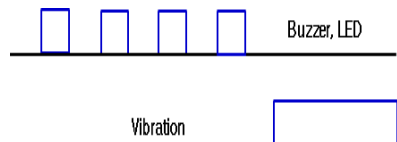

Adjust alarm setpoints

- To enter the setting mode, press and hold the Push button and power button simultaneously for two seconds.
- In the alarm setting icon, press and hold down the power button for 2 seconds.



- Press the Push button to change the alarm setpoints.
- Press the power button to save the value and move to the next step.

CAUTION

- Ensure that the high alarm setpoint must be greater than low alarm setpoint. Before the alarm adjustment, check with your safety manager or dealer authorized by SENKO. Alarm setpoints may vary by a country or company policy. Unless specified in your company's safety instruction, use the preset alarm setpoints.
- Ensure Standard Factory alarm set points vary depending on countries, states, and companies.
- Before changing alarm setpoints, ensure the alarm set points follow your local guidelines.

Data Log

1. The detector stores the last 30 event logs. If the data is filled, the new log event overwrites the oldest log events.
2. The data log is stored at every 1 minute interval, and it stores about 64,000 data logs. Once data log is filed, the new data log event overwrites the oldest log events.
3. Data logs consisting of event log, bump, calibration are stored at 1 minute interval.
4. To transfer event logs and data log to a computer, follow below steps.
 - Install the recent IR LINK software.
 - Connect the detector with a computer via a USB-C cable.*Refer to the more information in the PC program description part.

4. Setting Mode

4.2. Calibration

CAUTION

- Initial calibration is performed on all devices prior to shipment.
- The detector has fresh air calibration, N2 calibration and span calibration. All three calibrations are required to perform weekly, monthly, or quarterly depending on frequency of use. For instance, if a user use the detector every days, calibration need to be performed weekly or monthly, while the detector is used a few times per weekly or monthly, the quarterly calibration is required.
- Check with your safety managers to ensure frequency of calibration.
- Perform the fresh air calibration every 30 days. Note that Fresh air calibration should be performed in the arm's length to avoid the CO2 interference from breathing.
- Before calibration, move to a fresh air, which is free of toxic and combustible gases.
- If calibration fails, perform re-calibration again. If the repeated calibration continues to fail, contact authorized safety managers or distributors.
- The auto fresh air calibration can be set by the software manager. Once activated, the fresh air calibration is activated every 3 days. (Refer to page.13)

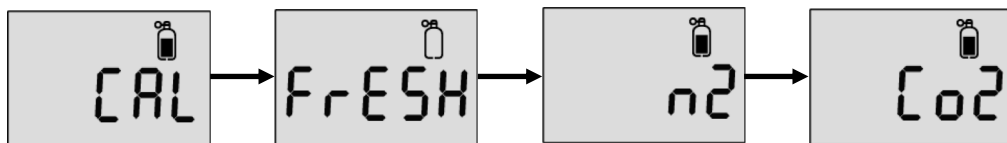

Calibration Gas

Gas Type	Fresh Air (O ₂)	N ₂	CO ₂
Concentration	20.9%vol	99.99%vol	20,000ppm, 2%vol

① Fresh Air calibration



1. In the measurement display, press and hold down the Push button and Power button to enter the setting mode.
2. Press the Push button until the CAL mode is displayed.
3. In the CAL mode, press the Power button for 2 seconds to enter the mode
4. In the arm's length like the right image, hold the detector and for 2 seconds and press the Power button to perform the fresh air calibration.
5. Once the calibration is successful, the success message (V) mark is displayed. But, if it fails, the FA message(X) mark is displayed.
6. After the successful calibration, the baseline is set to 400ppm(0.04%vol).

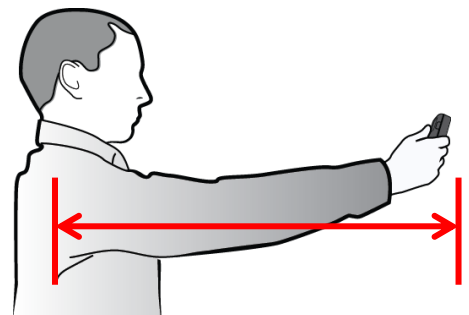

CAUTION

- CO₂ from breathing can interfere with the proper calibration. Ensure to hold the detector in the arms' length like the right image.

4. Setting Mode

② N2 Calibration



1. In the “CAL” mode, press the Push button to move to the “N2” calibration.
2. Plug the calibration cap to the detector and connect the calibration cylinder with N2 (99.9%vol)
3. Press the power button and release the N2 gas.
4. After 90 seconds, when N2 calibration is successful, success message(V) appears. But, If N2 calibration is failed, FAIL message(X) appears.

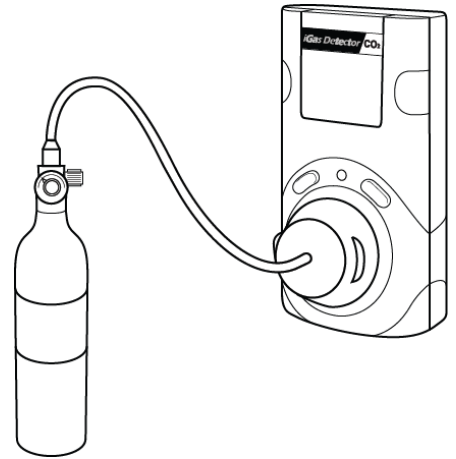

CAUTION

- Use the regulator with a flow rate of 0.5LPM(Liters per minute) of a gas cylinder.

③ Span Calibration



1. Press the Push button to move to span calibration.
2. Plug the calibration cap to the detector and connect the calibration cylinder with CO2 (20,000ppm)
3. Press the power button and release CO2 gas.
4. After 90 seconds, when the calibration is successful, success message(V) appears. If N2 calibration fails, fail message(X) appears.

CAUTION

- Do not change the calibration concentration unless dealers or safety managers authorized by SENKO give the permission to change to another calibration concentration.
- Use the regulator with a flow rate of 0.5LPM(Liters per minute) of a gas cylinder.

4.3. Clear max

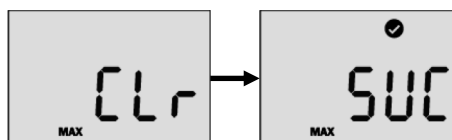

To delete the measured peak concentration in the detector, follow below steps.

1. Press the Push button & power button simultaneously and the Push button until Clr(max) is displayed.
2. Press the power button to clear the peak value.
3. After the successful activation, SUC(V) mark is displayed. If it fails, FA(X) mark is displayed.

4. Setting Mode

4.4. Clear STEL and TWA

To delete the measured STEL and TWA value in the detector, follow below steps

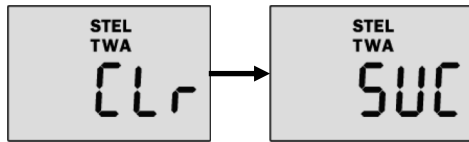

1. Press the Push button until Clr (STEL & TWA) is displayed.
2. Press the power button to delete the TWA and STEL value
3. After the successful activation, SUC with V mark is displayed.

4.5. Adjust Unit



To adjust a unit, press the Push button until

1. Press the Push button until Unit is displayed and power button to enter the mode.
2. Press the Push button to select a unit (ppm or %vol) and power button to save it.
3. After the successful activation, SUC(V) mark is displayed. If it fails, FA(X) mark is displayed.

4.6. Factory Reset

To restore the factory setting, please follow below steps.

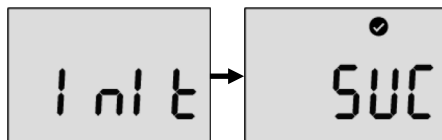

1. Press the Push button until "Initiate" is displayed.
2. Press the Power button to apply it.
3. After the successful activation, SUC(V) mark is displayed. If it fails, FA(X) mark is displayed.

4.7. Self Test

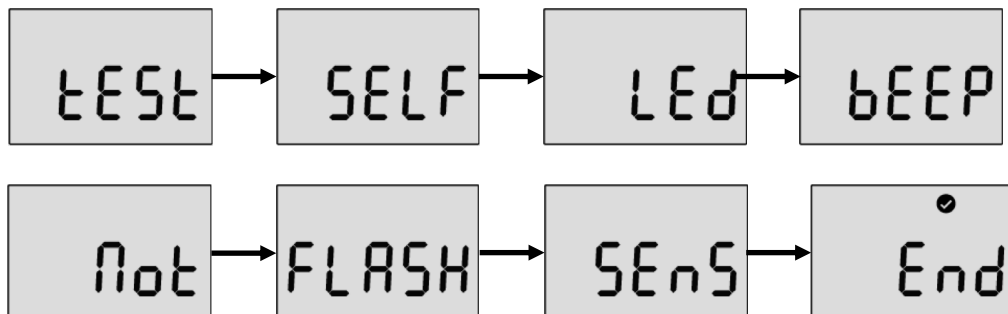

To perform the self diagnostic test, follow below steps.

1. Press the Push button until Test is displayed
2. Press the power button for three seconds. In the "SELF" display, press the power button for three seconds to activate the self test. While it's activated, the detector will test LED, beeping, vibration, flash memory, and sensor. After the successful test, V mark is displayed. If the test fails, FA with X mark is displayed.
3. If the self test fails, the Error message appears.

5. Software Manager

5.1. Software Overview

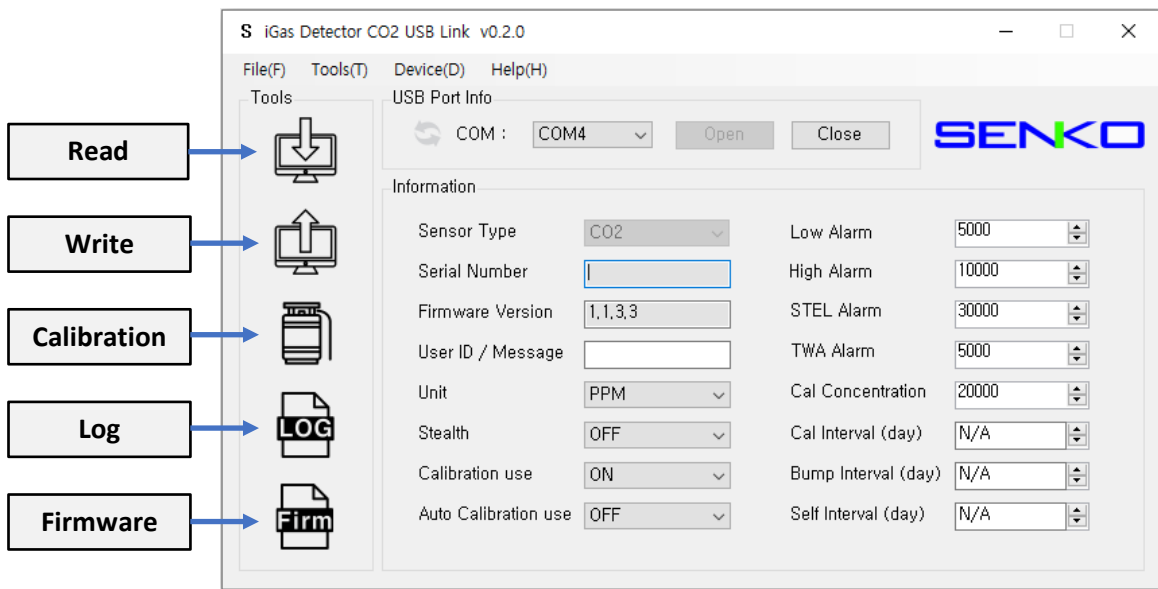

- **Sensor Type** – The current sensor type in the device (CO₂, cannot be changed)
- **Serial Number** – iGas Detector CO₂ serial number
- **Firmware Version** – Current firmware version of the unit (can change by upgrading)
- **User ID/Message** - The User ID can be used to add a usage message
- **Unit** – Adjust by PPM or %vol
- **Stealth** – Disable the alarm, buzzer, and LED for a special occasion
- **Calibration Use** – Disable the calibration process for a special occasion
- **Auto Calibration use** – Auto “Fresh Calibration” is activated every 3 days.
- **Low Alarm & High Alarm** – The 1st and 2nd alarm set points (Min/Max: 400ppm (0.04%vol) ~ 49,999ppm (5%vol))
- **STEL Alarm & TWA Alarm** – Short Term Exposure Limit and Time Weighted Average level of concentration of CO₂ (Min/Max: 400ppm (0.04%vol) ~ 49,999ppm (5%vol))
- **Gas Concentration** – This allows a user to enter/amend correct concentration of the gas cylinder (Min/Max: 400ppm (0.04%vol) ~ 49,999ppm (5%vol))
- **Calibration Interval (day)** – The calibration reminder informs every fixed day (can adjust 0 (n/a) ~ 365)
- **Bump Interval (Days)** – The Bump test reminder informs every fixed day (can adjust 0 (n/a) ~ 365)
- **Self Interval (Days)** – The Self test reminder informs every fixed day (can adjust 0 (n/a) ~ 365) *Default is N/A

Note:

- When the software is opened, the fields are grayed out and before it can be used, the “OPEN” button must be clicked.
- Without clicking the “Write” button, configured and customized settings will not be applied and neither be saved.
- If the USB connection is successful, the “Success” icon appears. If the connection fails, reconnect the USB cable or check the device manager to see the connection status.

5. Software Manager

5.1.1. Read

The “Read” button (upper-left side first icon) allows a user to retrieve the stored data.

5.1.2. Write

The “Write” button (upper-left side second icon) has one of the most important role in this software interface. Because every single and each configured or customized settings will be saved by clicking “Write” button. When a user configures the instrument’s settings, “Write” button will be clicked and message will pop-up. Click “Yes”.

5.1.3. Calibration

Calibration is the comparison of measurement values delivered by a device under test with those of a calibration standard of known accuracy. To perform the calibration using software, follow the below:

1. Connect the unit to the PC using instrument’s USB
2. Plug the calibration cap (not for Fresh air calibration) and open the software
3. Click “Calibration” (middle-left side icon) and wizard will come up
4. Choose the calibration gas type and click “Start”
5. The time for Fresh Calibration is 10seconds while for N₂ and CO₂ is 90 seconds

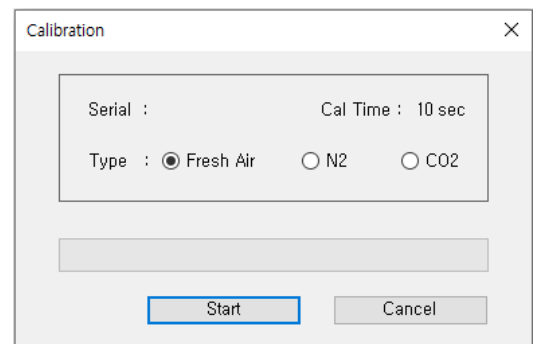

5.1.4. Log

All recent 30 logs will be stored in the device and will be automatically erases one by one from the earliest logs when new event occurs. There are two types of event logs, “Event Log” and “Event + Data log” are available to download. Choose the log and click “Download” button. The log files will be downloaded and created by unit’s Serial number and will be in “.csv” format. However, clicking “Erase” button will clean all the logs from the storage of device and cannot be recovered.

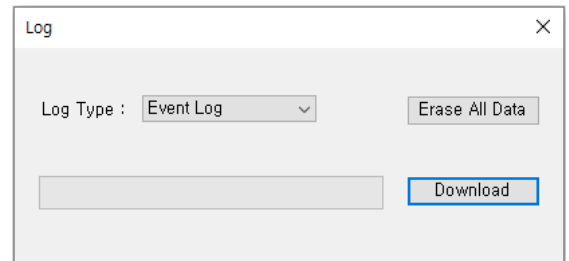

5.1.5. Upgrade (Firmware)

To upgrade the latest firmware version of iGas Detector CO₂, follow the below:

1. Click “Browse” button and navigate to the firmware location
2. Choose the firmware and click the “Open” button
3. Click “Write” to begin upgrading process
4. When upgrade is finished, power off the device and turn it on
5. The “F-UP” → “boot” message will come up and upgrade is complete

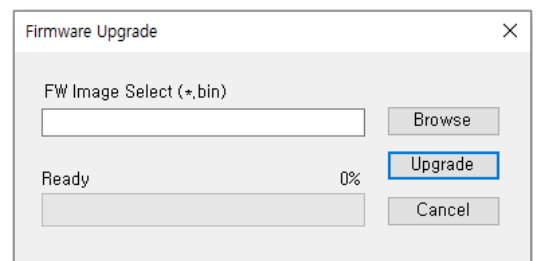

Note:

- Pressing “Cancel” button during the upgrading process will cancel and close the Firmware Upgrade Wizard.

5. Software Manager

5.2. Window menu

5.2.1. Menu – File

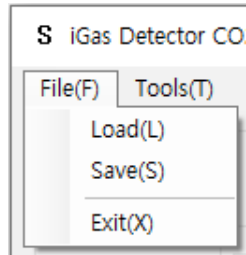

- **Load(L)** – Load the installed settings
- **Save(S)** – Save the current settings
- **Exit(X)** – Finish the work and end the program (close the tap)

5.2.2. Menu – Tools

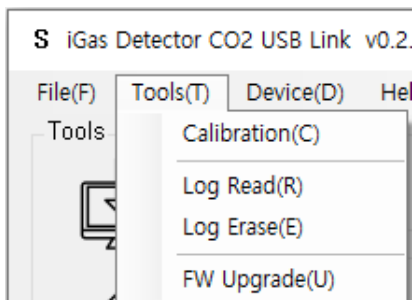

- **Calibration(C)** – Open the calibration window to start calibration process
- **Log Read(R)** – Retrieve and save the log events
- **Log Erase(E)** – Clean all the logs from the storage (erased logs cannot be recovered)
- **FW Upgrade(U)** – Open the firmware upgrade window to start upgrading process

5.2.3. Menu – Device

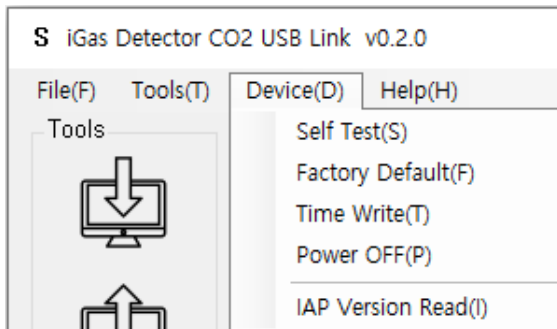

- **Self Test(S)** – Automatic self diagnose of the unit
Test order: LED → Beep → Motor → Flash → Sensor → End
- **Factory Default(F)** – Reset original settings and specifications
- **Time Write(T)** – To set a time by user location (see 8.2.3.1.)
- **Power OFF(P)** – Turn off the device
- **IAP Version Read(I)**

5.2.3.1. Menu – Device

- **Now Time** – When click “Now Time” button, automatically sets the current time on the PC of the operator. The initial time is preset in the factory in South Korea, so to apply the time in your location, press “Now time” and press “time write”.
- **Time Write** – By clicking “Time Write” button, selected and customized time will set.

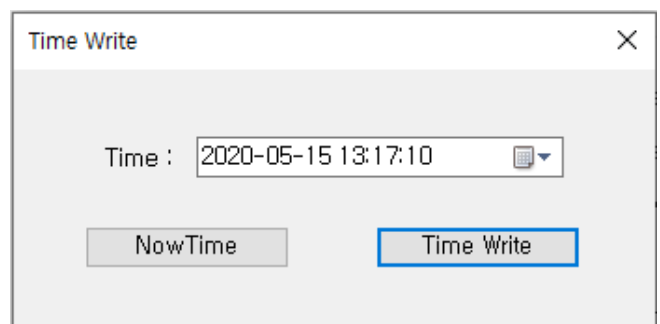

6. Maintenance

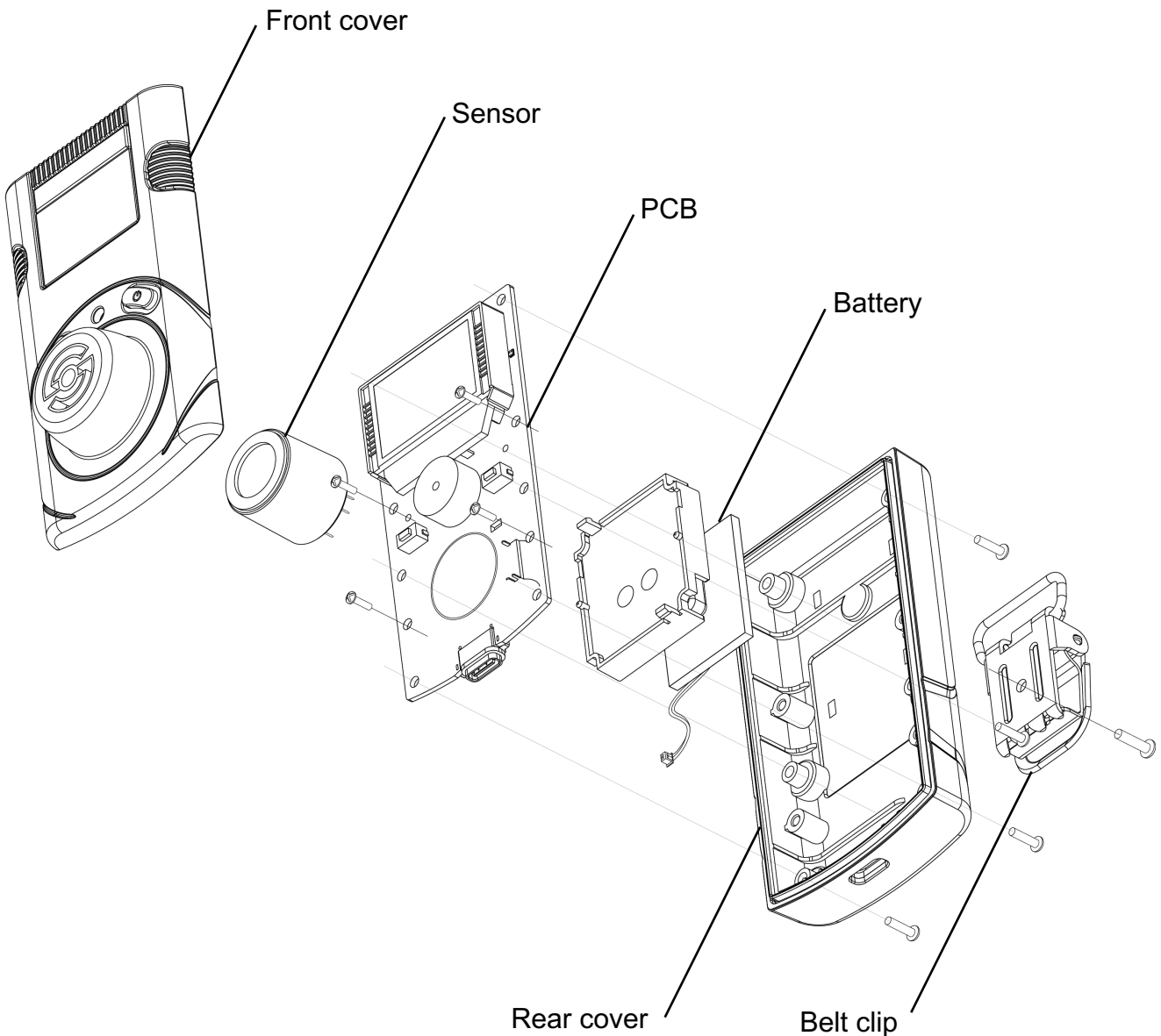

CAUTION

- Before disassembling the detector, power it off.
- It is absolutely prohibited to replace battery at potential explosion or dangerous regions. Replace the battery in a clean environment, which has no hazardous gases.
- Replacement of components can invalidate the intrinsic safety function. Replacing the sensor and battery should be performed by authorized sellers, agents, distributors, or safety managers.
- The sensors published by SENKO should be used for replacement.
Product: Rechargeable Li-ion(polymer) power supply unit (500mAh)
- Service task is limited to only for sensors & battery replacement. After the sensor, perform the fresh air, N₂ calibration, and span calibration.

6. Maintenance

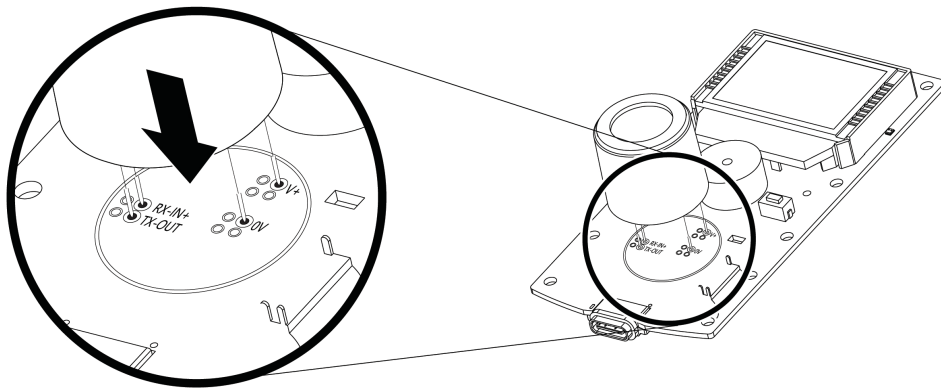

6.1. Sensor Replacement

1. Move to a fresh air environment and power off the detector.
2. Remove the back case by unscrewing the 6 screws.
3. Remove the 2 screws on the PCB Board.
4. Carefully replace with the new sensor provided by the authorized dealers or SENKO. Ensure the sensor pins are matched with the above image and the sensor is aligned with the PCB board.
5. Assemble the detector and turn on the detector.
6. After assembling, perform the fresh air calibration, N₂(99.9%vol) calibration, and standard calibration with CO₂ (2%vol)
7. Before use, stabilize the detector for 5 minutes.

CAUTION

- The sensor is soldered on the board. Before removing the sensor, desolder the sensor pins from the PCB board.

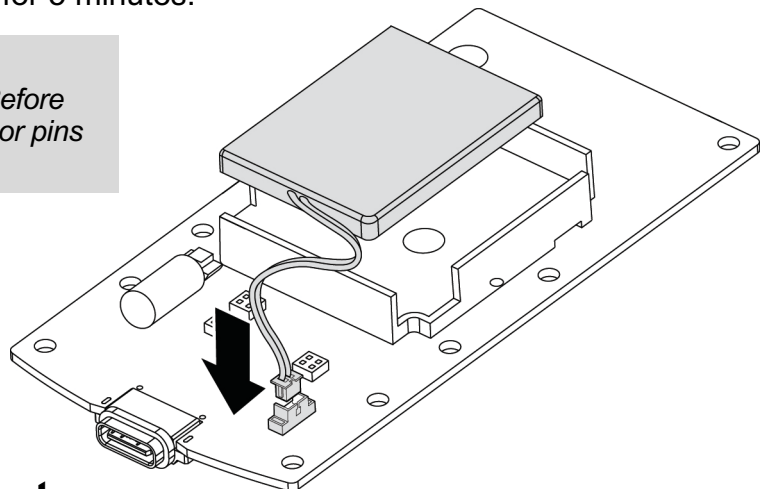

6.2. Battery Replacement

1. Move to a fresh air environment and power off the detector.
2. Remove the back case by unscrewing the 6 screws.
3. Remove the 2 screws on the PCB Board.
4. Carefully unplug the battery from the PCB board.
5. Place the new battery in the battery protection case.
Battery Specification: Rechargeable Li-ion(polymer) power supply unit (500mAh)
6. Assemble the detector and turn on the detector.
7. Perform the fresh air calibration, N₂(99.9%vol) calibration, and standard calibration with CO₂(2%vol)
8. Before use, stabilize the detector for 5 minutes.

7. Specification

Model	iGas Detector CO2
Sensor Type	IR
Measurement	Diffusion type
Display	LCD display
Audible	90dB at 10cm
Warning Lamp	Red Flashing LEDs
Vibration	Vibration Alarm
Battery	Rechargeable Li-ion(polymer) power supply unit (500mAh)
Charging Time	100 minutes
Temperature	-20°C ~ +50°C
Humidity	5%~95% RH (Non-condensing)
Case	Rubber Enclosure
Accessories	Calibration Cap, Charge Cable(USB C-Type) and adaptor
Flow Rate	Flow rate:
Size &Weight	Size: 30(W) x 50(H) x 35(D)mm , Weight: 120g
Operating Life	14 day(Expected)
Event Log	Recent 30 alarms(Expected)
Approval	EMC directive(2004/108/EC) * ROHS 2

Sensor Specification

Gas	Measuring range	Low Alarm	High Alarm
CO2	0~5.0%vol 0~50000ppm	0.5%vol 5000ppm	1%vol 10000ppm

Limited Warranty

SENKO warrants that this product is free from defects in workmanship and materials, under normal use and maintenance, for two years from the date of purchase from the manufacturer or authorized reseller of the product.

The manufacturer is not responsible (under this warranty) if its tests and examinations reveal that the alleged product defect does not exist or was caused by misuse, neglect or improper installation, tests or calibrations of the buyer (or third parties). Any unauthorized attempt to repair or modify the product, or any other cause of damage going beyond the intended range of use, in particular damage caused by fire, lightning, water damage or any other danger, cancels the manufacturer's liability.

In the event that a product does not perform according to the manufacturer's specifications during the applicable warranty period, please contact the authorized reseller of the product or the SENKO service center at + 44 191 428 3415 for repair / return information.



Senko Europe, Jarrow Business Centre, Viking Industrial Park, Jarrow, NE32 3DT, UK

Tel : +44 191 428 3415

Email : latest@senkoeurope.com Web : www.senkoeurope.com