

blacklinesafety
G7 EXO

Technical User Manual

CONTENTS

Contents

1	Overview	5
1.1	G7 EXO.....	5
1.2	Blackline Safety Cloud.....	5
1.3	Blackline Live web portal.....	5
1.4	G7 EXO Pump.....	6
1.5	G7 EXO Diffusion.....	9
1.6	Connection modules.....	13
2	Setup	14
2.1	Location.....	14
2.2	Mounting.....	14
2.3	Setup wizard.....	16
2.4	Connectivity light.....	16
3	User interface	17
3.1	Buttons.....	17
3.2	Screen overview.....	17
3.3	Battery.....	19
3.4	Power on/off.....	20
3.5	USING EXO'S convenience features.....	21
3.6	Maintenance code.....	25
3.7	Alarm test.....	25
3.8	Siren.....	26
3.9	Speaker.....	26
4	Safety alerts and alarms	27
4.1	Lower urgency alarm.....	27
4.2	Yellow warning alarm.....	27
4.3	Red alert.....	28
4.4	LiveResponse.....	28
5	Safety features	29
5.1	Functional settings.....	29
5.2	Gas sensor settings.....	30
6	Communication	31
6.1	Text messages.....	31
6.2	Two-way voice calls.....	31
6.3	Push-to-talk (PTT).....	32
6.4	Available channels.....	32
6.5	Changing channels.....	32
7	Gas detection	33
7.1	Bump test.....	33
7.2	Calibration.....	34
7.3	Zero sensors.....	35
7.4	LEL sensor precautions.....	36
7.5	PID target gases.....	36
7.6	Gas alert countdown.....	37
8	Cartridges	38
8.1	Cartridge options.....	38
8.2	Changing cartridges.....	38
8.3	Sensor contaminants.....	38
8.4	Sensors in cold weather.....	38
9	Gas inlets	39
9.1	Manual calibration inlet.....	39
9.2	Pump inlets.....	40
9.3	Gas sampling.....	40
9.4	Pump blocked alarm.....	40
10	Electrical ports	41
10.1	Cautions.....	41
10.2	Definitions.....	41
10.3	Power port.....	42
10.4	A/B interface ports.....	43
11	Over-the-air (OTA) firmware updates	47
12	Support	47
12.1	Learn more.....	47
12.2	Customer care.....	47
13	Specifications	48
13.1	Detailed specifications.....	48
13.2	Gas sensor specifications.....	49
14	Legal notices and certifications	50
14.1	Legal notices.....	50
14.2	INMETRO certification.....	50
14.3	Intrinsically safe certification.....	51

WARNINGS

The Warnings listed in this section are intended to alert you to possible hazards to people and/or equipment. The hazards may be intermittent or permanent.

▲ WARNING: Only remove EXO's battery in a safe environment with a clean atmosphere. Specifically, the atmosphere free of explosive gas. See page 19.

▲ WARNING: The EXO quick charger is NOT intrinsically safe. It should only be used in a safe environment with a clean atmosphere. See page 19.

▲ WARNING: DO NOT allow metal tools or personal items to touch the battery terminals. Touching metal or any conductive material to the battery terminals is extremely dangerous and will damage the battery. See page 19.

▲ WARNING: An attached trickle charger is ONLY intrinsically safe when connected as described in the electrical diagrams in section 10. See page 20.

▲ WARNING: Listening to EXO's siren at high volume for extended periods of time can cause permanent hearing loss. EXO's siren volume should be adjusted for use indoors and in smaller spaces. Wear appropriate ear protection during testing. See page 26

▲ WARNING: EXO's sensors must only be zeroed with clean air. If a sensor is zeroed where its targeted gas levels are abnormal, the gas levels EXO displays will not be accurate. Inaccurate readings are a safety hazard. See page 35.

▲ WARNING: Calibrations must only be performed in areas free of flammable gases. See page 36.

▲ WARNING: Off-scale (overlimit) readings may indicate an explosive concentration. See page 36.

▲ WARNING: If you start the pump while operating at temperatures of -20 C or lower, EXO will generate a pump blocked alarm (see section 9.4) that persists until the inlet warms up and begins operating normally. In a multiple inlet sampling cycle, the inlets do not have time to warm up. For temperatures below -20 C, use only single gas sampling. See page 40.

▲ WARNING: G7 EXO Pump cannot detect the following gases: Chlorine (Cl₂) and Chlorine Dioxide (ClO₂). See page 40.

▲ WARNING: Cables attached to the power port are only intrinsically safe when properly set up with an electrical barrier. See page 42.

▲ WARNING: EXO will NOT monitor during the installation process. See page 47.

1 OVERVIEW

1.1 G7 EXO

Cloud-Connected Area Monitor

G7 EXO is a cloud-connected area monitor that bundles industry-leading gas detection with automated compliance and business analytics tools. For the first time ever, the days of manually collecting data from the field, reviewing spreadsheets and compiling reports are behind you.

G7 EXO solves the challenges of continuous toxic and combustible gas monitoring for sites, facilities and fence lines. Automating long-term area monitoring and connected safety for streamlined efficiency, G7 EXO allows teams to focus on their work at hand.

In the event of a safety incident or gas exposure, monitoring personnel can see what has happened and communicate with workers directly via text messaging or an optional two-way voice calling feature through EXO.



1.2 BLACKLINE SAFETY CLOUD

The Blackline Safety Cloud is a cloud-hosted system consisting of cellular networks, satellite networks, the Blackline Live™ web portal application, your monitoring account and G7 EXO.

EXO comes with basic system access, which allows EXO to connect to the Blackline Safety Cloud. Depending on your needs and requirements, additional service plan options are available, including 24/7 safety monitoring by Blackline's Safety Operations Center and two-way voice communication.



1.3 BLACKLINE LIVE WEB PORTAL

The cloud-hosted Blackline Live web portal monitors and manages all of your workers and G7 devices, and delivers reports and business analytics insights.

Blackline Live

Blackline Live's real-time alerting and live map allows you to quickly locate and respond to gas events and other incidents in the field.

You can use Blackline Live to create and customize configuration profiles that determine how a device or a group of devices operates in the field. Similarly, alert profiles are set up to determine what contacts should be notified in the event of an incident and what response protocol monitoring personnel will follow to ensure your team gets the help it needs.

Blackline Live keeps track of alert history and gas sensor calibrations and bump tests, eliminating the need to manually retrieve data logs from the field.

Lastly, Blackline Live allows you to tailor user access depending on employee roles: employee, supervisor, administrator and monitoring team. This ensures that everyone has access to the right tools to accommodate their role in a comprehensive monitoring program.

For more information about Blackline Live, visit: support.blacklinesafety.com/products/blackline-live.

Blackline Analytics

With Blackline Analytics, you can review data collected from your EXO fleet to make decisions, follow up with your team and ensure everything is running smoothly. Choose from a number of different reports and filters to explore your data.

Blackline Analytics is built directly into the Blackline Live portal, allowing employees with the appropriate user access controls to see your organization's data. If users have only been given access to specific groups of devices, they will only see data attached to those particular devices.

For more information about Blackline Analytics, visit support.blacklinesafety.com/products/blackline-analytics.

1.4 G7 EXO PUMP

G7 EXO Pump has a manual calibration inlet that requires a fixed flow regulator to function correctly. It also has four pump inlets that can sample air from remote areas using internal pumps and external tubes.

1.4.1 IN THE BOX

G7 EXO Pump comes with the following components:

- G7 EXO Pump safety and area gas monitor
- This Technical User Manual
- 1m (3 ft) of tube fitted with a quick connect coupling insert
- Quick charger with battery pack hex key
- Pre-installed multi-gas cartridge
- Pre-installed cellular connection module
- Pre-installed gas inlet module (one of two)
- Optional pre-installed satellite connection module
- Certification and support card

1.4.2 FRONT



1.4.3 BACK



1.4.4 BOTTOM



1.4.5 RIGHT SIDE



1.4.6 LEFT SIDE



1.5 G7 EXO DIFFUSION

G7 EXO Diffusion has a manual calibration inlet that requires a fixed flow regulator to function correctly.

1.5.1 IN THE BOX

G7 EXO Diffusion comes with the following components:

- G7 EXO Diffusion safety and area gas monitor
- Wind guard
- This Technical User Manual
- 1m (3 ft) of tube fitted with a quick connect coupling insert
- Quick charger with battery pack hex key
- Pre-installed multi-gas cartridge
- Pre-installed cellular connection module
- Pre-installed gas inlet module (one of two)
- Optional pre-installed satellite connection module
- Certification and support card

1.5.2 FRONT



1.5.3 BACK



1.5.4 BOTTOM



1.5.5 RIGHT SIDE



1.5.6 LEFT SIDE

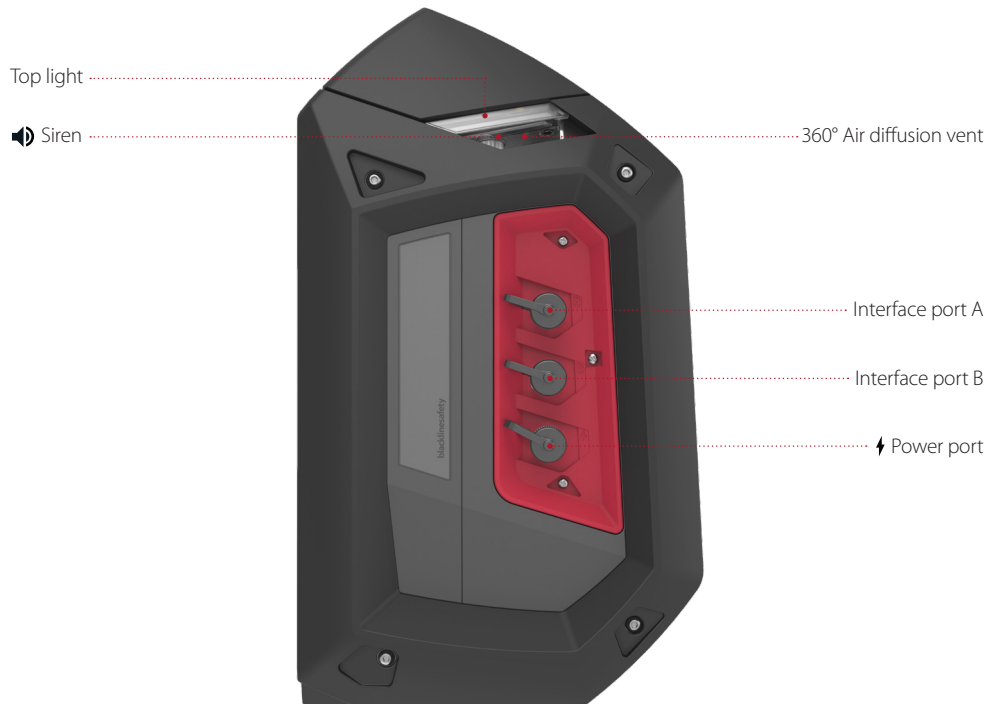

1.5.7 WIND GUARD

When bump testing or calibrating EXO Diffusion in windy conditions, the Wind Guard is required to help regulate the flow and concentration of gas delivered to the sensors.

1. Position the Wind Guard in front of EXO with the narrow ends on top, as shown below.
2. Slide the Wind Guard into the front 360° air diffusion vents (underneath the Top Lights). When the Wind Guard is in the proper position, the two clamps will lock.
3. Bump test or calibrate as usual.
4. When bump test or calibration is complete, immediately remove the Wind Guard and store for later use.



⚠ Warning: The Wind Guard **MUST** be removed when the bump test or calibration is complete. Failure to remove the Wind Guard will slow down EXO's response to hazardous gases.

1.6 CONNECTION MODULES

A connection module links EXO to the Blackline Safety Cloud using a cellular network or the Iridium satellite network.

EXO will first try to connect to the Blackline Safety Cloud with the built in cellular connection module. If cellular coverage is not available and an optional satellite connection module is installed, EXO will try to connect to the Blackline Safety Network through the Iridium satellite network. See sections 2.4 and 3.2 for more information on connectivity.

1.6.1 CELLULAR CONNECTION MODULE

This module works with 2G/4G networks in Europe, and 3G/4G networks in North America to connect EXO to the Blackline Safety Network. Cellular series are available in over 100 countries, supporting over 200 cellular networks. This module is built into every EXO.

1.6.2 SATELLITE CONNECTION MODULE

When EXO is not in cellular coverage, this module works with the Iridium satellite network to connect EXO to the Blackline Safety Cloud. This module can be pre-installed in EXO, or it can be purchased as an upgrade for EXOs in the field. For installation instructions, refer to the [G7 EXO Satellite Installation Guide](#) on the Blackline Support site.

NOTE: Two-way voice capabilities and push-to-talk (PTT) are not available when connected via satellite.

NOTE: You may experience a reduction in data collection while using the satellite module.

To change the connection type

By default EXO connects to the cellular network. To change to the satellite module, or from satellite to cellular, open the main EXO menu and use the arrows to select Communication. Then select the connection module you want to use. The Communication menu option is only available if a satellite module is installed.

You can tell which connection type EXO is using by the symbol displayed in the EXO main screen.



Cellular



Satellite



No connection

1.6.3 IS A SATELLITE MODULE INSTALLED?

If you are unsure if EXO has a satellite connection module installed, check the window behind the battery pack.

You can also find this information on the device:

1. Press OK to open the main menu.
2. Select **Advanced**.
3. Select **Comm info**.



Satellite connection not installed



Satellite connection installed

2 SETUP

2.1 LOCATION

EXO finds its location in one of three ways: through satellite-based positioning, by scanning for Blackline location beacons, or through a manually assigned location in Blackline Live.

NOTE: A defined location helps emergency response teams know where to respond. However, EXO does not need a determined location to function as a safety monitor or gas detector.

Satellite-based positioning (GPS)

EXO can use GPS, QZSS, Galileo, and BeiDou satellite constellations to determine its location. Satellite-based positioning works best when the monitor is outside with a clear view of the sky. If EXO is within a location beacon's signal radius and satellite-based positioning is also available, the one with the strongest signal strength will be used.

Location beacons

When within a beacon's signal radius, EXO will see the beacon and send the beacon's ID to Blackline Live. EXO's location will be recorded as the beacon's pre-defined location. If EXO sees multiple beacons, it will be associated with the beacon with the strongest signal strength. If beacons and satellite-based positioning are both available, the one with the strongest signal strength will be used. This is configurable on Blackline Live.

Manually assigned location

In locations where satellite signals are weak or unavailable, you can manually assign EXO's location on Blackline Live.

EXO performs best when placed strategically within the area you wish to monitor. When placing EXO, consider the following:

Positioning

- Keep EXO upright
- Keep EXO accessible for regular interactions like bump tests and messages
- Do not hang EXO by its handle. For hanging instructions, refer to the EXO Hanging Mount Guide on the Blackline Safety Support Center website

Environment

- Keep EXO's electrical ports and gas inlets covered when not in use
- Do not place EXO in water
- Consider wind direction and air flow

Connectivity

- If connecting to the Blackline Safety Cloud through a satellite network, EXO needs to be outdoors with a clear view of the sky
- If connecting to the Blackline Safety Cloud through a cellular network, EXO may struggle to find connection indoors or in areas of weaker cellular reception

2.2 MOUNTING

The base of the EXO is fitted with a mounting plate with two sizes of threaded mounting points. The use of all mounting points is not required to mount EXO. Select the appropriate mounting points for your application.

Type A Mounting Point

A single mounting point threaded 5/8 in – 11 with a maximum depth of 3/4 in or 19 mm.

Type B Mounting Point

Five mounting points that are M6 threaded with a maximum depth of 5/8 in or 16 mm.

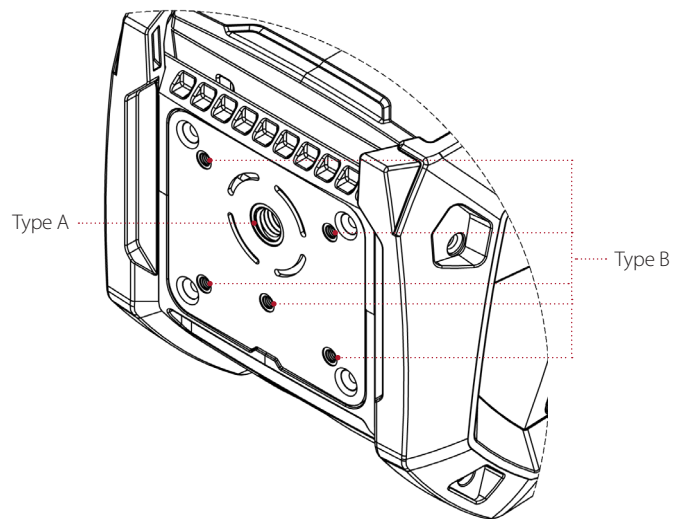

2.2.1 MOUNTING POINT LAYOUT

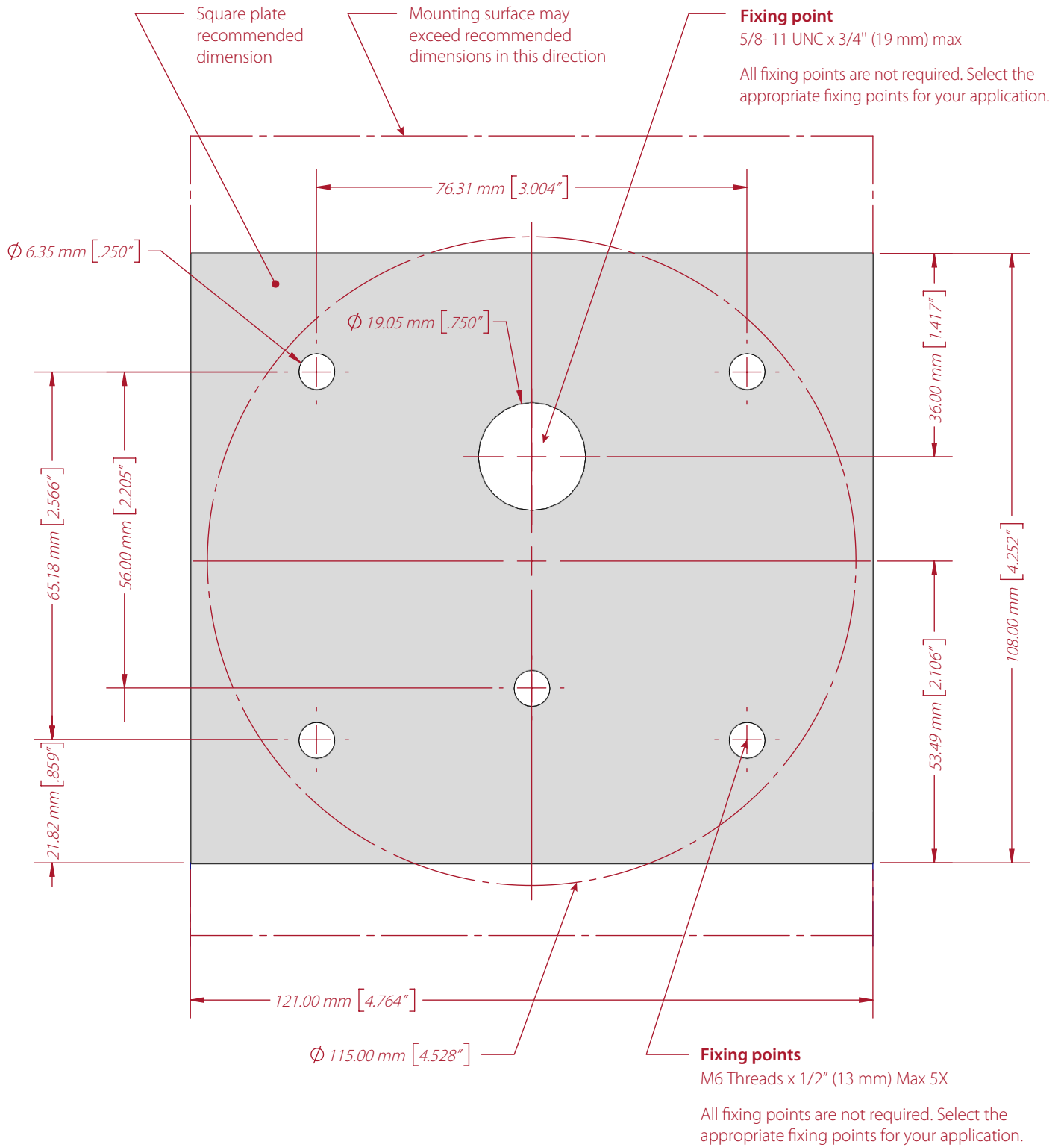

2.3 SETUP WIZARD

The setup wizard is an optional test that tells you if EXO will be able to operate correctly and fully. It determines if EXO can determine its location, if it can connect to the Blackline Safety Cloud and if it is vertical.

EXO will continue to monitor for gas in the area during the setup wizard test. Yellow warning alarms, an SOS latch pull or dangerous gas levels will override the setup wizard.

To run from start-up:

1. Power on EXO.
2. EXO will go through the start-up sequence.
3. At the end of the start-up sequence a prompt to start the setup wizard will display on the screen.
4. If no selection is made after 15 seconds, the prompt screen will time out and EXO will automatically go to the main gas detection screen without running the setup wizard.
5. If you choose to run the setup wizard, EXO will execute the process automatically. This process should only take a few minutes.

To run from the main menu:

1. Press the OK button to enter the main menu.
2. Select **Setup wizard**.
3. EXO will execute the process automatically. This process should only take a few minutes.

If setup wizard is successful:

1. EXO will let you know with a success sound and the screen will display "ready for use."
2. Select **Exit** to go to the main gas detection screen.

If setup wizard is unsuccessful:

1. EXO will let you know with a failure sound and the screen will display "Insufficient".
2. The reasons for the failure will be listed on the screen with a red X. There are three possible reasons for failure:
 - EXO could not determine its location.
 - EXO could not connect to the Blackline Safety Cloud.
 - EXO was not vertical.
3. Address each item on the list, then select **Retry** to run the setup wizard again.
4. Select **Exit** to skip the setup wizard and go to the main gas detection screen.

2.4 CONNECTIVITY LIGHT

EXO lets you know its connection status through the green connectivity light.

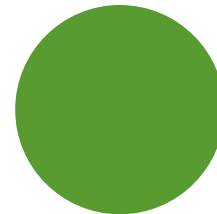

Blinking green light

A blinking connectivity light indicates EXO is trying to connect to the Blackline Safety Cloud. EXO will continue to monitor the area, although monitoring personnel cannot receive alerts while this light is blinking. Data collected by EXO while the green connectivity light is blinking will be sent to Blackline Live once EXO connects to the Blackline Safety Cloud. This includes red alerts, yellow alarms, location, messages, etc.

Solid green light

A solid connectivity light indicates EXO is connected to the Blackline Safety Cloud and all data collected by EXO is actively being transmitted to Blackline Live. Monitoring personnel will receive and respond to alerts while this light is solid.

Connection lost alarm

If EXO loses connection to the Blackline Safety Cloud, an information alarm with yellow lights will be triggered after a configurable length of time. If EXO reconnects to the Blackline Safety Cloud within this time limit, no alarm will be triggered.

See sections 1.6 and 3.2 for more information on connectivity.

3 USER INTERFACE

3.1 BUTTONS

Interacting with EXO is easy with its high-visibility, backlit LCD display, three-button menu system and SOS latch.



OK button

Press the OK button to enter the main menu on the LCD screen. Press the OK button to confirm a menu selection.



Up and down buttons

Use the up and down buttons to navigate options. Press and hold both buttons simultaneously to acknowledge and mute a yellow warning alarm or a red alert.



SOS latch pull

Pull the SOS latch to call for help when emergency assistance is required. See section 4.3 for more information.



Latch push (optional)

Push and hold the SOS latch to record a push-to-talk (PTT) message. Release the latch to send the message to devices in the same channel. See section 6.3 for more information.

3.2 SCREEN OVERVIEW

3.2.1 MAIN MENU

To enter the main menu, press the OK button while on the Gas status screen. The main menu contains additional features and device information available to EXO users.

3.2.2 GAS STATUS SCREEN

EXO's main screen is the **Gas status** screen. EXO's four-gas cartridge sensor configuration will determine the layout of this screen.

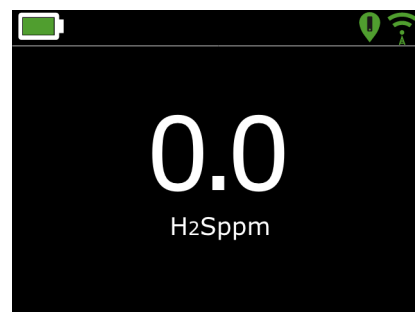

One gas

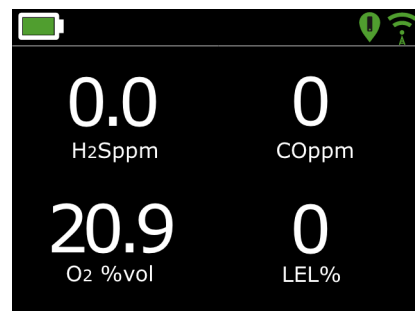

Four gases

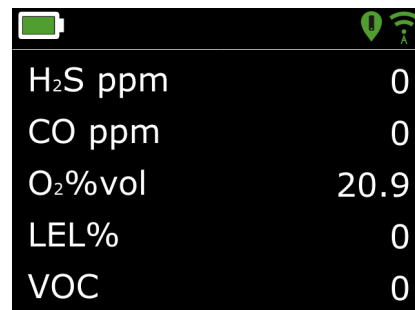

Five gases





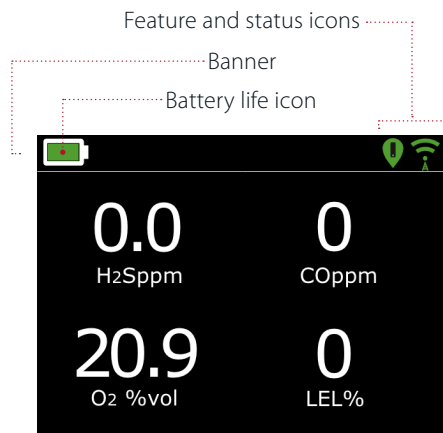

3.2.3 BANNER

The banner at the top of the gas status screen is where you will find more information about yellow alarms, red alerts, battery life, location and connectivity.



Battery life icon



The battery icon in the top bar of the screen shows how much charge the battery has. See section 3.3 for more information regarding the battery pack.

-  Lightning bolt: Battery charging
-  5 bars: 81% to 100%
-  4 bars: 61% to 80%
-  3 bars: 41% to 60%
-  2 bars: 21% to 40%
-  1 bar: 1% to 20%
-  Red bars: Low battery

NOTE: By default, a “Low battery” message will be displayed in the banner and the battery icon will become red when the battery’s power drops below 10%. This threshold is configurable on Blackline Live.



Location icon

Only one location icon will be displayed at a time. See section 2.1 for more information regarding EXO’s location.

-  **Beacon**
Displayed when a beacon signal is present
-  **Satellite positioning (GPS)**
Displayed when no beacon signal is present and satellite positioning is possible
-  **None**
Displayed when there are no beacon signals and satellite positioning is not possible

Connectivity icon

Only one location icon will be shown at a time. See sections 1.6 and 2.4 for more information about connectivity.

-  **Cellular**
Displayed when EXO is connected to the Blackline Safety Cloud through a cellular network
-  **Satellite**
Displayed when EXO is connected to the Blackline Safety Cloud through satellite
-  **None**
Displayed when EXO is NOT connected to the Blackline Safety Cloud

3.3 BATTERY

All EXOs are shipped with a pre-installed battery pack and a quick charger. The battery (labeled ACC-G7EXO-BATXX) comes in two models.

1. Standard (144 Ah): ACC-G7EXO-BAT
2. Lightweight (72 Ah): ACC-G7EXO-BAT-LT

Battery life

The standard battery pack can power EXO for over 100 days, and the lightweight version over 50 days. This will vary depending on device configurations, alarm and alert response, operating temperature, sensor types and pump usage. In operational temperatures below -20°C (-4°F), the battery pack's runtime will drop significantly. See section 8.4 for more information about running EXO in cold temperature.







Battery storage

For long-term storage, Blackline recommends the battery is stored at 20°C (68°F).

Battery gauge

Press and hold the battery gauge button on the battery pack to show how much charge the battery has.

NOTE: A dim bar indicates when the battery's charge is in the lower half of the bar's percentage range.

	1 bar blinking: 0-4%
	1 bar: 5-24%
	2 bars: 25-44%
	3 bars: 45-64%
	4 bars: 65-84%
	5 bars: 85-100%

Battery gauge while charging

The Battery gauge will automatically light up and remain lit while the battery pack is charging. The gauge will display the current charge of the battery pack as described above. When the battery reaches 100% it will stop charging and the gauge's lights will turn off.

3.3.1 USING THE QUICK CHARGER

The EXO quick charger connects directly to the EXO battery and charges it overnight.

▲ WARNING: Only remove EXO's battery in a safe environment with a clean atmosphere. Specifically, the atmosphere must be free of explosive gas.

▲ WARNING: The EXO quick charger is NOT intrinsically safe. It should only be used in a safe environment with a clean atmosphere.

▲ WARNING: DO NOT allow metal tools or personal items to touch the battery terminals. Touching metal or any conductive material to the battery terminals is extremely dangerous and will damage the battery.

Operating temperature for quick charger

The quick charger's ideal operating temperature is 22°C (72°F) but it can be used between 5°C and 40°C (41°F to 104°F) without any adverse effects.

To remove the battery to use quick charger:

1. Power off EXO.
2. Ensure EXO is in a safe environment with a clean atmosphere.
3. Loosen the two self-retaining screws at the top of the battery on the back of EXO.
NOTE: This requires a 4 mm hex key (included with EXO).
4. Pull the top of the battery away from EXO.
NOTE: When EXO is vertical, the battery will lean away from EXO, allowing you to grip and remove the battery.



Battery removal detail

To charge the battery using quick charger:

1. Lift the rubber flap at the top of the battery pack to expose the charging port.
2. Plug the quick charger into the battery's charging port.
3. Plug the quick charger into an outlet.
4. Turn the charger's power switch on. Charging may take up to 12 hours.
NOTE: The battery pack is fully charged when the red light on the charger turns green.
5. When fully charged, remove the quick charger from the charging port.
6. Replace the rubber flap to cover the charging port.

To insert the battery:

1. Ensure EXO is in a safe environment with a clean atmosphere.
2. Hold the battery at a 45 degree angle with the bottom pointing towards EXO.
3. Place the battery bottom first into EXO's battery slot.
4. Push the top of the battery towards EXO until it sits flush.
5. Tighten the two screws at the top of the battery.
NOTE: The screws should be snug, but not over-tight.

3.3.2 TRICKLE CHARGER

You may choose to buy an EXO Trickle Charger Kit from Blackline Safety. This kit connects EXO directly to a power source through the power port eliminating the need to power down and remove EXO from the field to charge the battery pack. See section 10.3 for more information about the power port.

▲ WARNING: An attached trickle charger is ONLY intrinsically safe when connected as described in the electrical diagrams in section 10.



Power port detail

3.4 POWER ON/OFF

To power on EXO, press and hold the power button for two seconds. You will know when EXO has finished its startup when it completes the following stages.

1. At the end of two seconds EXO will sound a chime, signaling it is powering on.
2. The top lights will flash.
3. EXO will go through its startup sequence and the screen will display the active features on EXO.
4. The green connectivity light will stop flashing and become solid when EXO is connected to the Blackline Safety Cloud.

NOTE: if you see an "O₂ stabilizing" message on G7 EXO's screen, it means EXO is not monitoring. Stabilization typically takes around 10 seconds. However, if EXO has been powered off for a significant period, it can take up to 20 minutes for the O₂ sensor to stabilize. If this message persists, contact your organization's safety professional.

To power off EXO, press and hold the power button for three seconds.

NOTE: If the maintenance code is enabled, you will be required to input the correct code to unlock EXO before powering off. See section 3.6 for more information about the maintenance code.

You will know when EXO has finished power off when it completes the following stages.

- EXO will show a three second countdown as you hold the power button. Every second will have a corresponding beep and flash.
- At the end of the three seconds EXO will sound a chime signaling it is powering off
- The screen will go into EXO's shutdown sequence
- Once all the lights and sounds have stopped, EXO will be powered off and disconnected from the Blackline Safety Cloud

NOTE: Make sure all red alerts have been resolved before powering off. Do NOT power off EXO if the blue LiveResponse light is on. This may mean waiting for monitoring personnel to contact you through EXO. See section 4.3 for more information on red alerts.

3.5 USING EXO'S CONVENIENCE FEATURES

Much like a smartphone, EXO will include the following convenience features that will make it easier for device users to do their jobs:

- Local time on device
- Timer
- Stopwatch

If EXO is being used in an area where cellphones are not permitted, these features will ensure users do not need to carry multiple devices in the field — EXO can act as an all-in-one solution.

Convenience features will always be available on EXO devices using firmware version 3.455 and higher — it will not be toggleable in the configuration.

3.5.1 LOCAL TIME IN BANNER

EXO now provides the option of showing the local time on the LED screen. The time will be displayed in the top right of the main status screen. Since this is also where the check-in timer is displayed, the user will have the option to choose what information they would like to see if they also have the check-in timer feature enabled.

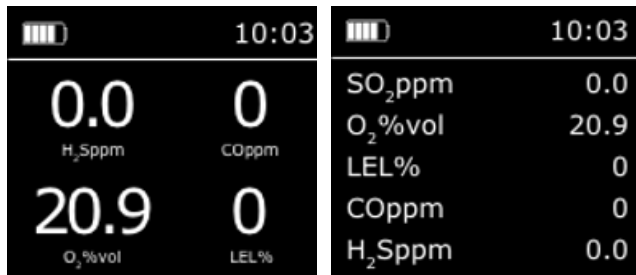

To display local time in the banner:

The banner can display the check-in timer or the local time. By default, if your EXO fleet is configured with the check-in timer enabled, the screen will display the check-in timer to ensure consistency with previous behavior.

Settings

← Back

Banner Check-in

Languages

Pump options

1. Press the OK button to open the main menu.
2. Use the up and down arrows to navigate to **Settings** and press OK to select.
3. Scroll to the **Banner** option. You should see what the banner is currently set to.

Change banner display to local time?

Yes No

4. To change the banner display, click the OK button and confirm the change. If the banner was previously set to **Check-in**, it should now be set to **Time** and vice versa.

Settings

← Back

Banner Time

Languages

Pump options

5. The new display option will be shown in-line with **Banner**.

3.5.2 SET LOCAL TIME ON EXO

By default, the local time feature will use information gathered from nearby cell towers to determine the timezone and current time based on location, similar to how a cell phone operates.

However, a cellular connection may be unavailable, or your physical location might be on the border between timezones. In these cases, the default settings may provide inconsistent timezone information, and you may need to manually enter a timezone.

To manually enter a timezone:

NOTE: Timezone offsets are relative to Greenwich Mean Time (GMT: 0:00). You may need to look up the offset of your local timezone with respect to GMT — remember to consider daylight savings if your region uses it. (The examples to the right use +1:30 as an offset.)

1. Determine the offset relative to GMT for your local timezone.
2. Press OK to open the main menu. Use the up and down arrows to scroll down the **Time** option and press OK to select.
3. Select **Time settings**.
4. Select **Custom offset**.
5. On the **Set time offset** screen, enter the offset relative to GMT:
 - Enter + or -
 - Enter the hour
 - Enter the minutes if applicable (see images to the right)
6. Once you have entered the offset, select one of the following:
 - **Yes** to confirm
 - **Edit** to make changes if needed
 - **No** if you no longer want to set an offset
7. Once you have input and confirmed the offset value, return to the **Gas status** screen. Check that the screen is displaying time based on the entered custom offset value.

To stop using a manual offset:

1. Press OK to open the main menu.
2. Select **Time**.
3. Select the **Auto** option. EXO will go back to using cellular information to determine the local time.

Enter the offset relative to GMT

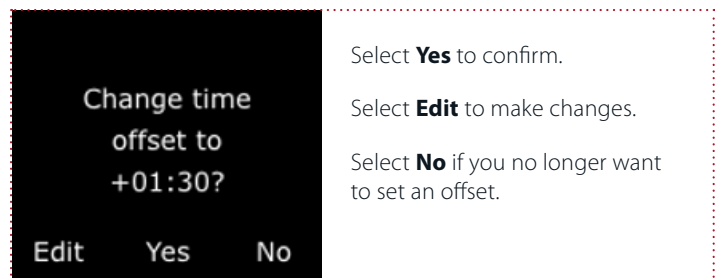
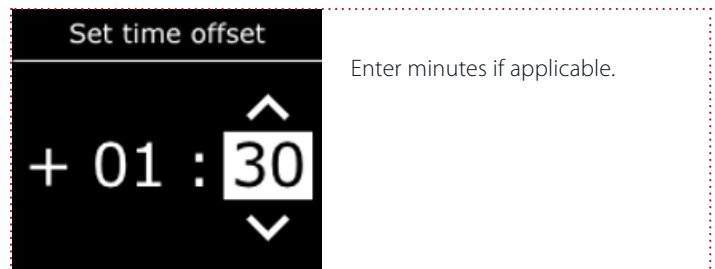
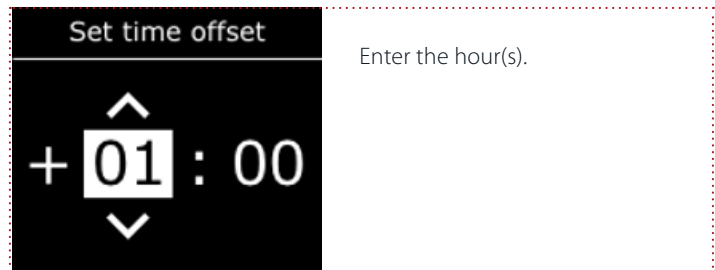
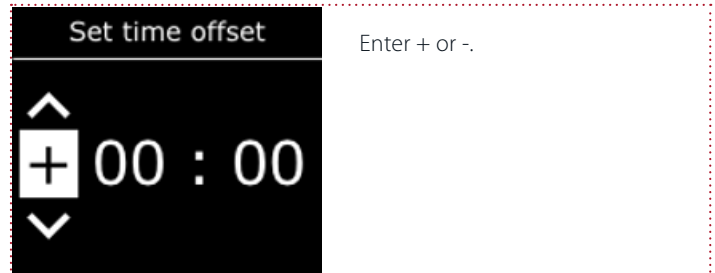

3.5.3 TIMER

To set the timer:

NOTE: The timer continues to count down even if you leave the screen.

Time	<ol style="list-style-type: none"> 1. Press OK to open the main menu. 2. Select Time. 3. Select Timer.
← Back	
Timer	
Stopwatch Time settings	

To view and stop the timer:

Time	<p>Once the timer is set, you can see the remaining time in the Time menu, in-line with the Timer option.</p>
← Back	
Timer 14:58:09	
Stopwatch Time settings	

Set timer	<ol style="list-style-type: none"> 4. On the Set Timer screen, select the unit of time (min or sec).
00 min	

Stop timer?	<p>To stop the timer early, go to Timer and select Yes.</p>
Yes No	

Set timer	<ol style="list-style-type: none"> 5. Use the up and down arrows to adjust the first digit for the time. 6. Press OK to select.
1 0 min	

Set timer	<ol style="list-style-type: none"> 7. Repeat steps 4 and 5 to adjust the second digit for the time.
1 5 min	

To stop the timer alarm:



Set timer for 15 min?	<ol style="list-style-type: none"> 8. Select Edit to make changes or Yes to confirm the timer duration.
Edit Yes No	

When the timer counts down to 0, EXO will go into an information alarm to inform the user to check the screen.

Press and hold the up and down arrows for three beeps to silence the alarm and clear the timer.

3.5.4 STOPWATCH

The stopwatch counts up in one second increments. It does not time out or use an alarm. It continues to count up in the background, even if you leave the stopwatch screen and return to the menu.

To set the stopwatch:

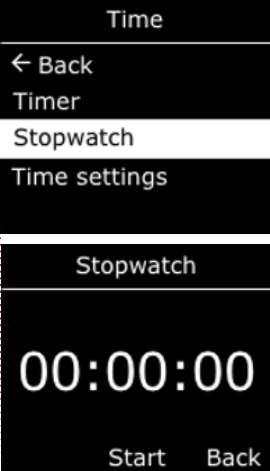

The screenshot shows a menu with the following items: Time, ← Back, Timer, Stopwatch, Time settings, Stopwatch, 00:00:00, Start, Back.

1. Press OK to open the main menu.
2. Select **Time**.
3. Select **Stopwatch**. The Stopwatch screen will open, showing the stopwatch at 00:00:00.
4. To start the stopwatch, select **Start**.

To pause or reset the stopwatch:



The first screenshot shows the Stopwatch screen with the time 00:12:34 and buttons Stop and Back. The second screenshot shows the Stopwatch screen with the time 00:15:54 and buttons Reset, Resume, and Back.

1. Open the **Stopwatch** screen.
2. Press the OK button to pause. After pausing, the **Stop** option will change to **Resume**, and the option **Reset** will be available.
3. To resume the stopwatch, press the OK button.
4. To reset the stopwatch, press the up arrow.

Where can I see how long the stopwatch been running?



The screenshot shows a menu with the following items: Time, ← Back, Timer 14:58:09, Stopwatch 00:01:23, Time settings.

To see how long the stopwatch has been running, open the **Time** menu.

The stopwatch will be displayed in-line with the **Stopwatch** option.

3.6 MAINTENANCE CODE

EXO features an optional maintenance code function to prevent unauthorized individuals from changing the settings when the device is unmanned. EXO's entire menu, device power-down and volume change actions are locked when a maintenance code is enabled. Entering the code will allow you to access locked features.

Enabling the maintenance code and setting the four-digit number passcode is done using the EXO configuration page available on the Blackline Live Portal.



When the device is locked, a lock icon will be shown in the gas status screen banner. Pressing any button while EXO is locked will display the maintenance code entry screen.

To unlock EXO:

1. Press any button to display the maintenance code entry screen. You will be prompted to enter a four-digit number.
2. Use the up and down buttons to select a number for the current digit.
3. Press OK to move on to the next digit.
4. After selecting the final digit, press OK to enter the entire code.

If successful, the entered code will become green and you will be taken to the unlocked **Gas detection** screen.

If unsuccessful, the entered code will become red.

You can either select **Retry** to enter another code, or **Back** to return to the locked **Gas status** screen.

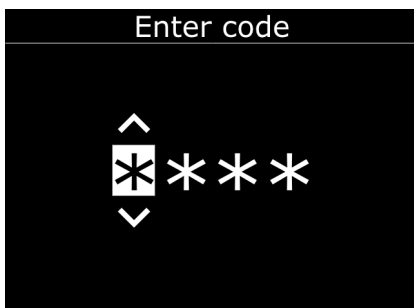

Enter maintenance code

3.7 ALARM TEST

EXO's alarm test is an audio/visual assessment used to ensure the siren, speaker, LED lights and microphones are operating correctly on the area monitor. The top lights will flash and you will hear pitches that gradually get higher. The volume of the alarm test sounds cannot be adjusted.

When is an alarm test run?

A alarm test is run during the following times:

- As part of the startup sequence
- Before all bump tests
- Before each calibration
- After every 24 hour period of continuous run time

What does a failed alarm test mean?

If EXO detects a problem while running the alarm test, the full test will immediately be attempted two more times. If EXO still detects a problem after the third attempt, a failed alarm test results will be recorded and sent to Blackline Live.

NOTE: Muffling the speaker during an alarm test will result in a failure. An environment that is too loud will also result in a failed alarm test.

3.8 SIREN

The siren is used to inform you of the following:

- Gas detection yellow warning alarms
- Red alerts
- SOS alerts
- Sensor errors

For EXO to function effectively as an area gas monitor, the siren must be loud enough to be heard over all environmental noise.

To adjust EXO's alarm volume :

1. Press OK to enter the main menu.
2. Select **Settings**.
3. Select **Siren volume**.
4. Use the up and down buttons to select the desired volume.

▲ WARNING: Listening to EXO's siren at high volume for extended periods of time can cause permanent hearing loss. EXO's siren volume should be adjusted for use indoors and in smaller spaces. Wear appropriate ear protection during testing.

3.9 SPEAKER

The speaker is used to inform you of the following:

- Yellow warning alarms triggered by incoming two-way messages
- Connection lost alarms
- Two-way voice calls
- Push-to-talk (PTT) messages
- Shutdown sounds

NOTE: EXO's speaker volume cannot be adjusted.



Detail of siren and speaker

4 SAFETY ALERTS AND ALARMS

4.1 LOWER URGENCY ALARM

EXO's lower urgency alarm uses the information sound and yellow lights. It can be triggered by low battery, connection lost, the timer, bump test reminders and calibration reminders. Settings are configurable on Blackline Live to best fit your needs. Contact your safety supervisor to learn more about how EXO's features are configured.

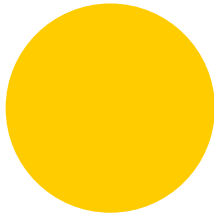

● ● ● ● ● Rapid Blinking ● ● ● ● ●

What do I do in the case of a lower urgency alarm?

Events that trigger lower urgency alarms do not need to be acknowledged right away. If EXO goes into a lower urgency alarm:

1. Read EXO's screen.
 2. Press and hold the up and down arrow buttons at the same time to mute the alarm and acknowledge the banner message.
 3. A safety supervisor or someone with proper training for EXO should perform specific tests or procedures to address the issue (e.g., calibrating the device).
- The lower urgency alarm repeats until a user presses and holds the up and down arrows for three beeps.
- Lower urgency alarms are between you and EXO and will not notify monitoring personnel if your device is monitored.



4.2 YELLOW WARNING ALARM

EXO's yellow warning alarm can be triggered by functional settings or reaching low alarm gas detection thresholds. Settings are configurable on Blackline Live to best fit your needs. Contact your safety supervisor to learn more about how EXO's features are configured.

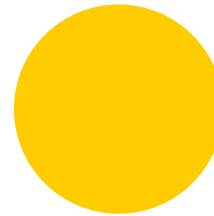

● ● ● ● ● Rapid Blinking ● ● ● ● ●

What do I do in the case of a yellow warning alarm?

Always follow your company's safety protocol for alarms and alerts. Blackline recommends leaving the area.

If EXO goes into yellow alarm:

1. Read EXO's screen and inform personnel if they need to leave the area.
2. Press and hold the up and down arrow buttons at the same time to mute the alarm and acknowledge the banner message.

Yellow warning alarms are between you and EXO and will not notify monitoring personnel if your device is monitored.

NOTE: For continuous gas exposure, EXO will unmute itself after two minutes if gas levels have not returned to normal.



4.3 RED ALERT

EXO's red alert can be triggered by pulling the SOS latch or by reaching high alert gas detection thresholds. Both are configurable on Blackline Live to best fit your needs. Contact your safety supervisor to learn more about how EXO's features are configured.

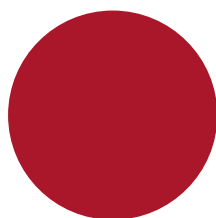

● ● ● ● ● **Rapid Blinking** ● ● ● ● ●

What do I do in the case of a red alert?

Immediately follow your company's safety protocol and evacuate the area. If you know the area is safe and your company's protocol allows you to stay in the area:

1. Read EXO's screen.
2. Press and hold the up and down buttons at the same time to mute the alarm and acknowledge the banner message.



NOTE: For continuous gas exposure, EXO will unmute itself after one minute if detected gas levels have not returned to normal.

NOTE: If your organization is monitored, red alerts are immediately communicated to monitoring personnel. If gas levels return to normal or you manually mute the sound, this does NOT cancel the alert sent to monitoring personnel.

4.4 LIVERESPONSE

EXO's blue LiveResponse light can only be triggered by monitoring personnel through Blackline Live. It is a signal to you that the red alert has been acknowledged and is being investigated by monitoring personnel. If you see this light, you can be confident help is on its way.

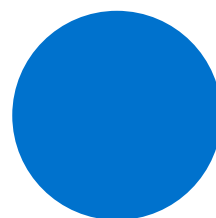

● ● ● ● ● **Blinking** ● ● ● ● ●

What do I do in the case of a blue LiveResponse light?

You do not have to do anything.

This light lets you know that remote monitoring personnel are responding to the alert by following your team's emergency protocol. Once monitoring personnel have confirmed the safety of everyone in the area and resolved the red alert, the blue LiveResponse light will shut off.

Depending on your team's response protocol, an EXO with voice enabled can also be contacted by monitoring personnel to create a two-way conversation between the end user and the monitoring agent responding to the alert.



WARNING: Do NOT power off EXO if the blue LiveResponse light is on.

5 SAFETY FEATURES

5.1 FUNCTIONAL SETTINGS



Two-way messages

EXO can send and receive written messages with monitoring personnel. When there is an incoming message, EXO will inform you with a yellow warning alarm. See section 6.1 for more information on two-way messages.



Connection lost

A yellow alarm will be triggered if EXO loses connection with the Blackline Safety Cloud and stays disconnected for 10 minutes. This amount of time is configurable on Blackline Live. See section 1.6 for more information on connection module.



Two-way voice call

If EXO has the two-way voice call feature enabled and is in cellular coverage, it can receive two-way voice calls from monitoring personnel as a response to red alerts. You cannot initiate or end voice calls from EXO. Voice calls are automatically answered by EXO. See section 6.2 for more information on two-way voice calls.



Low battery

If the battery pack charge goes below a default threshold of 10%, EXO will inform you with a warning message in the banner on the gas status screen. This threshold is configurable on Blackline Live. See section 3.3 for more information on EXO's battery pack.



Push-to-talk (PTT)

If EXO has the PTT feature enabled and is in cellular coverage, it is able to send and receive voice messages with other G7 EXO devices and G7 wearable devices, similar to a walkie-talkie. See section 6.3 for more information on PTT.



SOS latch

If you require emergency assistance, you can manually trigger a red alert by pulling the SOS latch. This will send an SOS alert to monitoring personnel and initiate your company's response protocol. The SOS alert can be disabled in the configuration from Blackline Live. See section 4.3 for more information on red alerts.

5.2 GAS SENSOR SETTINGS

Once you have completed a bump test (section 7.1) and calibration (section 7.2), EXO is ready to monitor and notify you about gas exposures.

Low gas threshold reached (low gas)

When gas levels reach the low concentration threshold configured by your safety supervisor, EXO will inform you with a yellow warning alarm. The sounds and lights will persist until gas concentrations return to safe levels.

NOTE: EXO with an O₂ sensor installed will trigger low warning alarms in oxygen-deficient and oxygen-enriched atmospheres. An oxygen-deficient atmosphere poses a risk of insufficient oxygen for breathing. An oxygen-enriched atmosphere presents an increased risk of explosion.

High gas threshold reached (high gas)

When gas levels reach the high concentration threshold configured by your safety supervisor, EXO will inform you with a red alert. The sounds and lights will persist until gas concentrations return to safe levels. .

NOTE: EXO with an O₂ sensor installed will trigger red alerts in oxygen-deficient and oxygen-enriched atmospheres. An oxygen-deficient atmosphere poses a risk of insufficient oxygen for breathing. An oxygen-enriched atmosphere presents an increased risk of explosion.

Sensor error

If a gas sensor stops working for any reason, EXO will go into a yellow warning alarm. For most sensors, the screen will display an **X** to indicate the sensor in error.

For EU customers using pellistor (catalytic bead) sensors, errors will not be detected until the next bump test/calibration. Refer to your pellistor user manual for more information.

If EXO is displaying a sensor error, power off and restart. If the sensor error persists, ensure the cartridge is installed properly. The cartridge may need to be replaced.

Over limit (OL)

If gas concentration is higher than a sensor's capability to detect, a red alert will be triggered.

Under limit (UL)

It is possible for a sensor to give negative readings. This is typically a result of improper calibration, cross-sensitivity to other gases or poisoning. If these negative readings become too low, the device will warn the user by initiating an under limit warning.

The banner will display "Under limit" and the gas sensor will give a reading of "UL". This warning notifies the user that the readings are inaccurate. If this happens, a calibration will be required to ensure the sensors are accurately detecting gas levels. If you are unable to perform a calibration and are in a clean atmosphere, you can zero the sensors to reset their baseline.

Bump test due

When gas sensors are due for a bump test, EXO will go into a low urgency alarm and the banner will display "Bump test due." The bump test interval is configurable on Blackline Live. See section 7.1 for more information on bump tests.

Calibration due

When gas sensors are due for a calibration, EXO will go into a low urgency alarm and "Calibration due" will display in the banner. The calibration interval is configurable on Blackline Live. See section 7.2 for more information on calibration.

6 COMMUNICATION

6.1 TEXT MESSAGES

EXO can send and receive text messages with monitoring personnel. You have the choice to send one of 10 pre-programmed messages or write a custom message. This message will be sent to Blackline Live as an alert. The pre-programmed messages are configurable on Blackline Live.

Messages can also be sent from Blackline Live and received by EXO. A yellow warning alarm will inform you of an incoming message.

To send a pre-programmed message:

1. Press the OK button to enter the main menu.
2. Select **Messages**.
3. Select **Send a message**.
4. Select a pre-programmed message. EXO will display a confirmation screen and then bring you back to the **Gas status** screen.

To send a custom message:

1. Press the OK button to enter the main menu.
2. Select **Messages**.
3. Select **Send a message**.
4. Select **Create custom**.
5. Press the up or down buttons to scroll through the alphabet and numbers.
6. Press the OK button to move to the next character.
NOTE: Messages cannot exceed 16 characters.
7. Press the OK button again to finish the message.
8. Press the up button to continue editing, OK to send, or down to cancel.

To read received messages:

1. Press the OK button to enter the main menu.
2. Select **Messages**.
3. Select **Message inbox**.

6.2 TWO-WAY VOICE CALLS

If EXO has the two-way voice call feature enabled and is in cellular coverage, it can receive two-way voice calls from monitoring personnel as a response to red alerts.

Two-way voice calls only work when EXO is connected to the Blackline Safety Cloud through a cellular network. G7 EXO automatically answers every voice call. You cannot initiate or end voice calls from EXO.

How does a two-way voice call work?

Monitoring personnel will initiate the call. If EXO is not already in an alert state, it will inform you of the incoming call with a yellow warning alarm. You will then hear a chirp indicating the voice call has been connected.

Speak directly to EXO. The microphone is located to the left of the SOS latch (see section 1.4.2 or 1.5.2). If monitoring personnel are having a hard time clearly hearing your responses, you may need to move closer to EXO. When monitoring personnel have confirmed you are safe, they will end the call and you will hear another chirp indicating the voice call has been disconnected.

NOTE: This feature is different from the push-to-talk (PTT) feature. Voice calls are not available when EXO uses the Iridium satellite network to connect to the Blackline Safety Cloud.

Volume

Two-way calls use EXO's speaker. The speaker's volume cannot be adjusted. See section 3.9 for more information about the speaker.



Blackline monitoring personnel

6.3 PUSH-TO-TALK (PTT)

If EXO has the PTT feature enabled and is in cellular coverage, it is able to send and receive voice messages with other G7 EXO devices and G7 wearable devices, similar to a walkie-talkie. EXO can still receive and send PTT transmissions when it is locked by a maintenance code. See section 3.6 for more information on the maintenance code.

PTT only works when EXO is connected to the Blackline Safety Cloud through a cellular network. PTT does not work during an alert or alarm unless the alert or alarm has been muted. PTT only allows one transmission on a channel at a time.

Volume

PTT uses EXO's speaker. The speaker's volume cannot be adjusted. See section 3.9 for more information about the speaker.

To transmit PTT calls:

1. Press and hold the red latch.
2. When EXO finishes beeping, continue to hold and begin talking into the device.
3. When you're finished talking, release the latch. EXO allows PTT messages up to 30 seconds in length.
4. EXO will beep once more to let you know it's done listening.

To receive a PTT call:

1. EXO will beep twice to signal an incoming PTT message.
2. EXO will play the message.
3. EXO will beep once more when the message is finished.
NOTE: EXO's screen will display its current channel.

6.4 AVAILABLE CHANNELS

Channels 00 through 99

These channels are recommended for everyday use. When on a specific numbered channel, EXO:

- Transmits to devices on the same channel as EXO
- Receives transmissions from devices on the same channel as EXO, as well as transmissions from devices in the all-call channel

All call channel

This channel is recommended for safety supervisors or managers. The all call channel is the highest priority PTT channel. Incoming all call transmissions will override other PTT transmissions. When on the all call channel, EXO:

- Transmits to all PTT devices in EXO's organization
- Receives transmissions from devices in the all call channel

Receive only channel

When on the receive only channel, EXO:

- Cannot transmit to any devices
- Receives transmissions from devices in the all call channel

6.5 CHANGING CHANNELS

To change to a specific channel number:

1. Press the OK button to enter EXO's main menu.
2. Select **PTT channels**.
3. Select **Enter channel #**.
NOTE: Every channel requires two digits
4. Use the up and down buttons to enter the first digit of the new channel. Example: for channel 08, the first digit is 0.
5. Press the OK button to move on to the next digit.
6. Use the up and down buttons to enter the second digit of the new channel. Example: for channel 08, the second digit is 8.
7. Press the OK button to finish.
8. Select **Yes** to confirm the new channel, or select **Edit** to make changes.

To change to receive only or all call:

1. Press the OK button to enter EXO's main menu.
2. Select **PTT channels**.
3. Select **Receive only** or **All call**.
4. Read the message on the screen.
5. Select **Yes** to confirm.

7 GAS DETECTION

7.1 BUMP TEST

What is a bump test?

A bump test will tell you if EXO's gas sensors, lights, siren, speaker and microphone are functional. The results of each bump test will be sent to the Blackline Safety Cloud automatically.

Bump test schedule

The bump test schedule can be configured to match your company's safety policy. These changes are made in the configuration profile on Blackline Live.

Blackline recommends that your bump test interval not exceed 30 days. Where site or regulatory requirements are more stringent, Blackline recommends the more stringent requirements apply.

The bump test process results in either a pass or a fail. Exiting the bump test process before all sensors have been tested will result in a failed bump test. On startup EXO will display when the next bump test is due. By default, an overdue bump test will cause a reminder message to display in the banner of the gas status screen. This bump test overdue response is configurable on Blackline Live.

Gas cylinders

Sensors can be manually bump tested at the same time using one gas cylinder with a multi-gas mixture, or individually using multiple gas cylinders. If using multiple cylinders, the manual bump test process will need to be repeated for each cylinder. In step 2 of the bump test process (section 7.1.1), ensure all the gas sensors that correspond to the attached cylinder's gas mixture are checked. The gas concentration of the connected gas cylinder should match the gas concentration listed in EXO's calibration gas configuration in Blackline Live.

NOTE: Some cartridges require you to bump test sensors in a specific order due to gas sensor cross sensitivity. Refer to [Gas Sensor Cross Sensitivity](#) on the Blackline support site for details.



Tube connected to EXO's manual calibration inlet

7.1.1 MANUAL BUMP TESTS

To perform a manual bump test, you will need:

- A cylinder or cylinders containing the appropriate gas(es)
- A 0.5 LPM or 1 LPM fixed flow regulator attached to the cylinder(s)
- A tube fitted with a quick connect coupling insert

NOTE: If you are bump testing G7 EXO Diffusion in a windy environment, you must use the wind guard. See section 1.5.7 for more information on using the wind guard.

To perform a manual bump test:

1. Ensure G7 EXO is in clean air.
 2. Press the OK button to enter the main menu.
 3. Select **Gas options**.
 4. Select **Bump test**. A screen will open displaying the message, "Continue with bump test?"
 5. Select **Yes**. EXO will run an audio/visual self test. See section 3.7 for more information.
 6. A screen will prompt you to start the bump test. Ensure all the gas sensors you wish to bump test are checked. By default, EXO will test all sensors.
 7. Select **Start bump**.
 8. EXO will begin to count down from 60 seconds. Within this time window:
 - Attach a tube fitted with a quick connect coupling insert to EXO's manual calibration inlet.
- 
- Ensure the other end of the tube is attached to the fixed flow regulator on the gas cylinder.
 - Turn the gas regulator on to apply the gas, keep gas flowing.
 9. Turn the gas regulator off when prompted by EXO.
 10. You will be prompted to go through steps 2-5 until all sensors have been tested. The bump test process is only considered successful once all the sensors have been successfully tested.
 11. If all sensors have been successfully tested, press the OK button to complete the bump test. This screen will timeout after a few seconds. EXO will inform you if the bump test has passed or failed and when its next bump test is due.
 12. Remove the tube from the manual calibration inlet and let EXO sit until the gas readings stabilize. This may take a few minutes.

If a bump test fails:

- Check the gas and cylinder connections
- Let EXO sit until its gas readings stabilize
- Try the bump test again

If the bump test continues to fail, contact your organization's safety supervisor.

7.2 CALIBRATION

What is calibration?

Calibration ensures EXO can accurately detect gas. This procedure adjusts sensor parameters while the sensors are exposed to a known concentration of gas for a set amount of time. Calibrations will need to be done periodically throughout a sensor's operating life and the data collected from each procedure will be sent to the Blackline Safety Cloud automatically.

Calibration schedule

The calibration schedule can be configured to match your company's safety policy. These changes are made in the configuration profile on Blackline Live. All the sensors on a cartridge will have the same calibration schedule, but if you choose to calibrate sensors individually, they can become due independent of the other sensors. Blackline recommends calibrating all the sensors on a cartridge in a single calibration process. On startup EXO will display when the sensors' next calibrations are due. By default, an overdue calibration will cause a reminder message to display in the banner on the gas status screen. This overdue response is configurable on Blackline Live.

NOTE: Blackline recommends not exceeding 180 days without a calibration.

Gas cylinders

Sensors can be manually calibrated at the same time using one gas cylinder or individually using multiple gas cylinders. If using multiple cylinders, the manual calibration process will need to be repeated for each cylinder. In step 4 of the calibration process below, ensure all the gas sensors that correspond to the attached cylinder's gas mixture are checked. The gas concentration of the connected gas cylinder should match the gas concentration listed in EXO's calibration gas configuration in Blackline Live.

NOTE: Some cartridges require you to calibrate sensors in a specific order due to gas sensor cross sensitivity. Refer to [Gas Sensor Cross Sensitivity](#) on Blackline support for details.

7.2.1 MANUAL CALIBRATION

For a manual calibration, you will need:

- A cylinder or cylinders containing the appropriate gases
- A 0.5 LPM or 1 LPM fixed flow regulator attached to the cylinder(s)
- A tube fitted with a quick connect coupling insert

NOTE: If you are calibrating G7 EXO Diffusion in a windy environment, you must use the wind guard. See section 1.5.7 for more information on using the wind guard.

To perform a manual calibration:

1. Ensure G7 EXO is in clean air.
2. Press the **OK** button to enter the main menu.
3. Select **Gas options**.
4. Select **Calibration**. A screen listing the configured calibration settings will open, followed by a screen that says, "Continue with calibration?".
5. Select **Yes**. EXO will run an audio/visual self test. See section 3.7 for more information.
6. A screen will prompt you to zero the sensors. Ensure all the gas sensors you wish to calibrate are checked. By default, EXO will zero all sensors.



Tube connected to EXO's manual calibration inlet

7.3 ZERO SENSORS

EXO's sensors can be zeroed manually if EXO is in a known clean environment. EXO can be configured to zero its sensors automatically on startup and they are also zeroed as a part of the calibration process. Contact your safety supervisor to learn more about how EXO's features are configured.

NOTE: The LEL-MPS sensor will auto-zero at startup. This is not configurable. See section 7.4 for more information about LEL sensors.

7.3.1 MANUALLY ZERO SENSORS

You can zero a sensor by using the atmosphere to reset the sensor's baseline reading. Inert purge gas may also be applied to the manual calibration inlet to zero sensors.

WARNING: EXO's sensors must only be zeroed with clean air. If a sensor is zeroed where its targeted gas levels are abnormal, the gas levels EXO displays will not be accurate. Inaccurate readings are a safety hazard.

To zero sensors:

1. Ensure G7 EXO is in clean air.
2. Press the OK button to enter the main menu.
3. Select **Gas options**.
4. Select **Zero sensors**.
5. A screen will prompt you to zero the sensors. Ensure all the gas sensors you wish to zero are checked.
6. Select **Start zeroing**.
7. A message will indicate when the zeroing is completed.

If you see a "Zero incomplete" message on G7 EXO's screen:

- EXO may be in an environment with abnormal gas levels
- EXO's cartridge may need to be replaced

7. Select **Start zeroing**. All checked sensors will be zeroed in preparation for their calibration. This will take a few seconds.
8. A screen will prompt you to select a gas mix. Ensure all the gas sensors you wish to calibrate with the chosen gas cylinder are checked. By default, EXO will attempt to calibrate all sensors that have been successfully zeroed.
9. Select **Start span**.
10. EXO will begin to count down from 60 seconds. Within this time window:
 - Attach a tube fitted with a quick connect coupling insert to EXO's manual calibration inlet.



- Ensure the other end of the tube is attached to the fixed flow regulator on the gas cylinder.
 - Turn on the gas regulator and apply the gas, keep gas flowing.
11. Turn the gas off when prompted on EXO's screen.
 12. You will be prompted to go through steps 8 to 11 until all zeroed sensors have been calibrated. The calibration process is only considered successful once all the sensors have been calibrated.
 13. If all sensors have been successfully calibrated, you will be prompted to press the OK button to complete the calibration. This screen will timeout after a few seconds. EXO will let you know if the calibration has passed or failed and when the next calibration is due.
 14. Remove the tube from the manual calibration inlet and let EXO sit until the gas readings stabilize.

If you see a "Calibration fail" message on G7 EXO's screen:

- Check the gas and cylinder connections
- Check that cylinder gas concentrations match the EXO calibration gas configuration
- Let EXO sit until its gas readings stabilize
- Try the calibration again

If the calibration continues to fail, contact your organization's safety supervisor.

If you know EXO is in a clean atmosphere and a gas sensor is reading abnormal levels, this can mean the sensor's baseline has shifted, and EXO's displayed gas readings are not accurate. Try calibrating the sensor. If the sensor is still reading abnormal levels, you may need to zero the sensor.

7.4 LEL SENSOR PRECAUTIONS

For safety reasons, EXO must be operated and serviced by qualified personnel only. Read and understand the information below before operating or servicing.

▲WARNING: Off-scale (overlimit) readings may indicate an explosive concentration.

▲WARNING: Calibrations must only be performed in areas free of flammable gases.

Blackline's LEL sensors can be calibrated with the following settings:

Gas	Calibration concentration (%vol)	Calibration concentration (%LEL)	Balance
Methane (CH ₄)	2.5%	50% ±2%	Standard quad-gas mixture

No known gases desensitize or contaminate Blackline's LEL-MPS and LEL-IR sensors. These two sensors do not cause any electromagnetic interference (EMI), and are not negatively affected by EMI, such as radio transmissions, of up to 8W.

Some compounds will decompose on the catalyst of the LEL-P and form a solid barrier over the catalyst surface. This action is cumulative, and prolonged exposure will result in an irreversible decrease in sensitivity. The most common of these substances are: compounds containing lead or sulphur; silicones; phosphates.

Some other compounds, especially hydrogen sulphide and halogenated hydrocarbons, are absorbed or form compounds that are absorbed by the catalyst of the LEL-P. The resulting loss of sensitivity is temporary. In most cases a sensor will recover after a period of operation in clean air.

Like any gas sensor, be sure to understand potential explosive hazards and choose the appropriate sensor technology based on these hazards.

Blackline Safety supports three different LEL sensor technologies:

1. Molecular Property Spectrometer (LEL-MPS)
2. Non-Dispersive Infra-Red (LEL-IR),
3. Pellistor (catalytic bead) (LEL-P) (EU only)

Molecular Property Spectrometer (LEL-MPS)

This sensor is not intended for inert environments. Environments with oxygen (O₂) levels below 18% will negatively impact this sensor's accuracy and Blackline does not recommend using it when oxygen levels are below 10%.

When bump testing or calibrating this sensor, apply a gas mixture containing at least 18% oxygen (O₂). Less oxygen than this may negatively impact the sensor's readings. If a gas mixture with less than 18% oxygen is applied during a bump test or calibration, restart EXO to auto zero the sensor.

This sensor can be calibrated two ways: default calibration and full calibration.

1. The default calibration process will validate and ensure accuracy without adjusting the LEL-MPS sensor's readings. Unlike traditional sensors, this sensor is factory-calibrated for optimal accuracy. We recommend using the factory calibration for the lifetime of the sensor.
2. Advanced users can perform a full calibration with a span adjustment. A full calibration may negatively impact the accuracy of other gases. EXO can be configured to run a full calibration on this sensor in Blackline Live.

Non-Dispersive Infra-Red (LEL-IR)

This sensor is able to function in inert environments without oxygen. This sensor does not detect Hydrogen (H) or Acetylene (C₂H₂).

Pellistor (catalytic-bead) (LEL-P)

Any rapid up-scale reading followed by declining or erratic reading may indicate a gas concentration beyond upper scale limit, which may be hazardous.

Photoionization detector (PID) sensors can be used to detect a large

7.5 PID TARGET GASES

range of gases called volatile organic compounds (VOCs). The PID sensor's target gas refers to whatever gas your device is currently attempting to detect. EXO's readings will be adjusted based on the gas it is currently configured to detect.

NOTE: Although PID sensors target a specific VOC gas, readings can still be affected by the presence of non-targeted gases. Consult your safety supervisor or industrial hygienist when preparing to use a PID sensor.

How do I set EXO's target gas?

EXO's PID sensor's target gas is set from the configuration profile in Blackline Live. Under the photoionization detector section of the gas sensor settings card, you can choose an existing target gas or set a custom target gas.

Where do I see which target gas EXO is detecting?

The target gas EXO is configured to use can be seen in two places:

- On startup
- In the gas options menu, Gas options > View gas info > VOC target

In both places EXO's screen will display the name of the target gas as well as its correction factor.

7.6 GAS ALERT COUNTDOWN

The gas alert countdown is an optional gas feature that creates a short delay before a high gas alert is delivered to Blackline Live and to monitoring personnel.

This feature will help to prevent false alarms from being delivered to monitoring services. Gases like CO and O₂ can spike and dip very quickly, setting EXO into high gas alarm even when gas levels go back to normal.

How does the countdown work?

Typically, when a device's high gas threshold — determined in the configuration profile — is crossed, the device will immediately send an alert to Blackline Live. This is done so that monitoring personnel can investigate the incident and follow up with the device user to ensure their safety.

Since the alert is sent immediately, it can create false alarm scenarios where monitoring personnel will be alerted even though the exposure was momentary and the device user is back in a safe area.

When the gas alert countdown feature is enabled, the device will wait a configured amount of time before sending the alert. EXO will still display red lights and an alert sound so the user knows to leave the immediate area.

With the gas alert countdown enabled, the banner at the top of the screen will show the remaining time before an alert is sent to Blackline Live. If gas levels return to normal before this time has elapsed, the alert will be cleared. The gas exposure will still be visible in the device history view on Blackline Live, but will not appear as an alert in the Alerts list.

How do I set up the gas alert countdown feature?

The gas alert countdown feature will be turned off by default. To set up this feature:

1. Log into Blackline Live and go to the G7 EXO configuration profile. In the gas sensor settings section under each individual sensor, there will be two settings:
 - A toggle labeled **Gas alert countdown**
 - A dropdown field labeled **Gas alert timeout**
2. Flip the toggle on for each sensor you want the countdown enabled for and determine the length of buffer time from the **Gas alert timeout** dropdown.

After the configuration is saved and the devices successfully receive the new settings, the gas alert countdown feature will be enabled.

For instructions, see the Blackline Support Centre website and search for [Gas Alert Countdown](#).



Gas alert countdown

8 CARTRIDGES

8.1 CARTRIDGE OPTIONS

What cartridge can be used with EXO?

EXO can only use multi-gas (diffusion) cartridges, which can be configured to detect up to five gases when using a dual CO and H₂S (COSH) sensor.

Power off EXO before changing the cartridge.

NOTE: All Blackline Safety cartridges are intrinsically safe. This means EXO's cartridges can be changed in potentially hazardous zones.



Multi-gas diffusion cartridge

8.2 CHANGING CARTRIDGES

To remove a cartridge:

1. Power off EXO.
2. Unscrew the four cartridge cover screws.
NOTE: These are captive screws and should stay attached to the cartridge cover.
3. Pull forward on the cartridge cover to remove. Set aside.
4. Pull the cartridge out of the cartridge slot.

To insert a cartridge:

1. Orient the cartridge so the sensors are facing down.
2. Push the cartridge into the cartridge slot.
3. Replace cartridge cover.
4. Tighten screws.



Inserting a cartridge

8.3 SENSOR CONTAMINANTS

Gas sensors are susceptible to contamination by a variety of common chemicals, reducing or eliminating their effectiveness.

For details on preventing sensor contamination, see [Cartridge and device cleaning for G7](#) on the Blackline Support site.

8.4 SENSORS IN COLD WEATHER

G7 EXO operates optimally in the range of -20 C to +50 C. For best practices operating G7 EXO outside that range, see [Operating G7 in Cold Weather](#) on the Blackline Support site.

Electrolyte sensors

At temperatures below -20°C (-4°F), the sensor electrolyte inside CO, H₂S and other electrochemical sensors can freeze over time, reducing the ability of the sensor to give a meaningful output. Storing EXO in a warm and humid (60% relative humidity) environment when not in use will help keep electrochemical sensors running longer.

Shocking an electrochemical sensor from room temperature to extreme cold and vice versa can also cause temporary drifts in sensor readings. These readings typically resolve in less than 60 seconds.

Infrared (IR) LEL sensors

Sudden temperature and humidity changes may cause condensation within the LEL-IR sensor, which can affect its optics and trigger a temporary baseline drift. Typically, they last less than 60 seconds, after which point the readings will recover and EXO will function as normal.

Shocking the IR sensor from room temperature to an extremely cold environment can cause a temporary baseline drift, typically less than 10% LEL. If this drift persists you can manually zero the sensor in the cold environment.

Shocking the IR sensor from an extremely cold environment to room temperature can cause a temporary baseline drift, sometimes reaching overlimit.

9 GAS INLETS

9.1 MANUAL CALIBRATION INLET

The manual calibration inlet allows you to apply gas to EXO's sensors during the bump test and calibration processes.

Fixed flow regulator

A gas cylinder with a fixed flow regulator is required to use the manual calibration inlet. This inlet relies on the gas pressure in the attached cylinder to bring the gas to the sensors.

Calibration cap

EXO does not need a calibration cap. The manual calibration inlet ensures the applied gas is fed directly to EXO's sensors.

NOTE: EXO cannot be bump tested or calibrated while a pump inlet is running (see section 9.2).

Attach tube

The manual calibration inlet is fitted with a quick connect coupling nozzle. Attaching a tube to this inlet requires the tube to have the corresponding quick connect coupling insert.

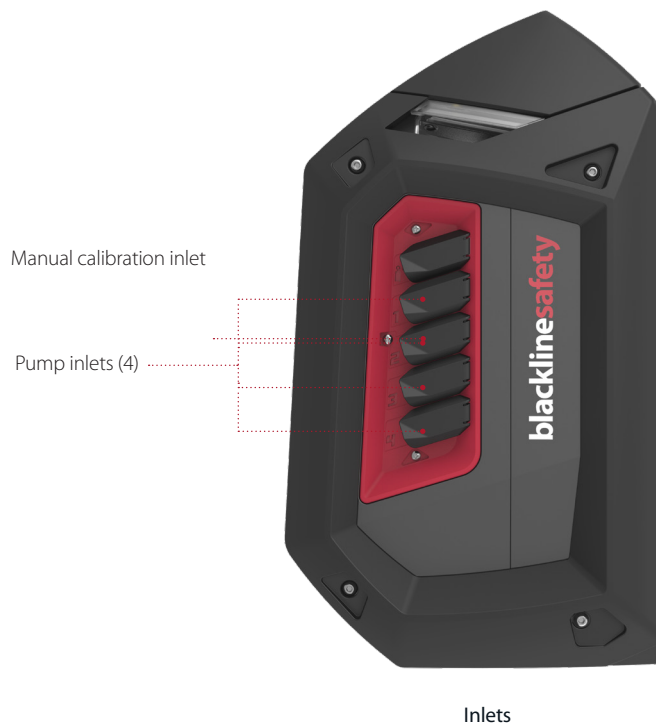

9.2 PUMP INLETS

The pump inlets allow one EXO to monitor multiple remote areas using tubing. Inlets must be assigned before they're functional.

NOTE: Although EXO Pump inlet filters are an optional accessory, Blackline recommends always installing inlet filters to maintain the pump in good condition. See [G7 EXO Pump Inlet Filters](#) on Blackline's support site for more information.

To assign inlets:

1. Power on EXO and press OK to open the main menu.
2. Use the arrows and OK button to select **Gas options**.
3. Select **Inlet settings**. By default, the pump inlets (1-4) will display as **OFF**.
4. Attach a tube to the inlet you want to use. Each pump inlet is fitted with a quick connect nozzle. Attaching a tube to these inlets requires the tube to have a corresponding quick connect coupling insert.
5. Select **Inlet settings**, and select the inlet you connected the tube to in step 4. Use the arrow buttons and OK to toggle the inlet to **ON**. This pump inlet is now functional.



Attaching a tube to an inlet

Purge gas

When an inlet is toggled on, EXO spends two minutes purging. It draws in air to displace any gas that is currently inside EXO and in contact with the cartridge sensors. The purge lasts two minutes, and gas readings are not available during EXO's purging process.

▲WARNING: Gas alarms or alerts will NOT be generated during a purge.

9.3 GAS SAMPLING

G7 EXO Pump has four inlets to enable flexibility in set-up and gas sampling.

▲WARNING: When in pump mode, EXO cannot detect the following gases: Chlorine (Cl_2) and Chlorine Dioxide (ClO_2).

Single gas sampling inlet

When one inlet is toggled on, EXO will continuously draw air in from that inlet.

▲WARNING: If you start the pump while operating at temperatures of -20 C or lower, EXO will generate a pump blocked alarm (see 9.4) that persists until the inlet warms up and begins operating normally. In a multiple inlet sampling cycle, the inlets do not have time to warm up. For temperatures below -20 C , use only single gas sampling.

EXO will first purge for two minutes to clear out any gas from the sensors, then draw air from the inlet that has been turned on. When EXO draws from one inlet, it runs continuously from that inlet.

This set-up is best for confined space entry, or any other situation where it is vital to continuously sample from a hazardous area.

Multiple gas sampling inlets

When multiple inlets are toggled on, EXO will begin a sampling cycle.

To ensure you always know where gas exposures are coming from, EXO will only pull in gas from one inlet at a time. Note that when multiple inlets are toggled on, EXO will need to go through each inlet one at a time.

EXO will also need to purge in between each of the samples to displace gas from the previous sample. While EXO is purging itself, there will be gaps in readings.

A sample cycle typically looks like the following:

Purge > Sample from inlet 1 > Purge > Sample from inlet 2 > Purge > Sample from inlet 3...

Due to these gaps in readings, a multiple-inlet sample setup is best used for long-term monitoring of remote areas.

Sample schedule

By default, the sample time from each inlet is three minutes. If you are running all four inlets with default settings (3 minute sample time + 2 minute purge time), there will be a 20 minute gap between readings from a given inlet.

The sample time can be extended in EXO's configuration profile on Blackline Live. Refer to the Blackline Live User Guide for instructions.

Pump automatically

By default, pumps remain off when EXO starts. You can change the EXO configuration profile on Blackline Live so pumps automatically turn on when EXO starts. Refer to the Blackline Live User Guide for instructions.

9.4 PUMP BLOCKED ALARM

To ensure dust and debris do not get inside the device, EXO's pump inlets are closed when there is nothing connected to them. Turning on a pump inlet without a tube connected may result in a pump blocked alarm with yellow lights and sounds to let you know there is no gas coming in from the inlet.

The pump blocked alarm will also sound when:

- Gas flow is restricted by something blocking the mouth of the tube
- The tube gets bent or normal flow is obstructed in another way
- The EXO is operating in temperatures of -20 C or colder.

A pump block detected event displays on Blackline Live.

You can mute the alarm by pressing and holding the up and down arrows, or by connecting an unobstructed tube to the inlet that is trying to pull in air. Once an unobstructed tube is connected, the inlet will open to allow air flow, and the alarm will end.

10 ELECTRICAL PORTS

10.1 CAUTIONS

Ordinary Locations

When used in a non-Hazardous (Classified) Location, cables attached to the power port and Pins 1 and 2 of the A/B interface ports must be supplied by a Class 2 circuit, a limited energy circuit or a limited power source (LPS) as per IEC 61010-1, IEC 60950-1, or an equivalent IEC standard. The output should not exceed any of the applicable input entity parameters.

Follow local electrical codes

The wiring method used to install EXO's electrical port accessories should be in accordance to local electrical code. Installations are subject to acceptance by the authority having jurisdiction.

Barriers required

A barrier is required for each interface port when EXO is in Class I, Division 1, Groups A,B,C,D location, or Class I, Zone 0/1, Group IIC location. See diagram 10.4.6 for more information.

Intrinsic safety warning

Install EXO's electrical port accessories as shown in the electrical diagrams in sections 10.3.1 and 10.4.1 to ensure intrinsic safety.

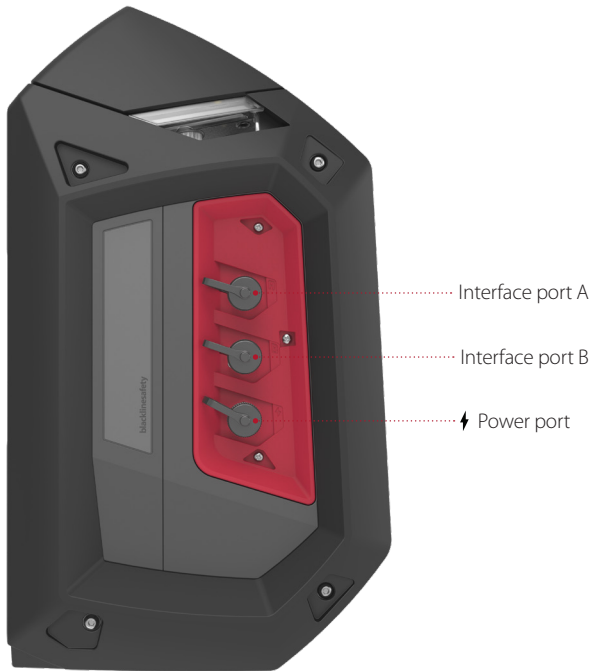

EXO ports

10.2 DEFINITIONS

Low-side switch

A low-side switch completes the circuit on the ground side. It is intended to sink power rather than provide power.

Ui – Maximum input voltage

The maximum voltage (peak a.c. or d.c.) that can be applied to the connection facilities of apparatus without invalidating the type of protection.

Ii – Maximum input current

The maximum current (peak a.c. or d.c.) that can be applied to the connection facilities of apparatus without invalidating the type of protection.

Pi – Maximum input power

The maximum power that can be applied to the connection facilities of apparatus without invalidating the type of protection.

Ci – Maximum internal capacitance

The maximum equivalent internal capacitance of the apparatus which is considered as appearing across the connection facilities.

Li – Maximum internal inductance

The maximum equivalent internal inductance of the apparatus which is considered as appearing at the connection facilities.

Uo – Maximum output voltage

The maximum voltage (peak a.c. or d.c.) that can appear at the connection facilities of the apparatus at any applied voltage up to the maximum voltage.

Io – Maximum output current

The maximum current (peak a.c. or d.c.) in apparatus that can be taken from the connection facilities of the apparatus.

Po – Maximum output power

The maximum electrical power that can be taken from the apparatus.

Co – Maximum external capacitance

The maximum capacitance that can be connected to the connection facilities of the apparatus without invalidating the type of protection.

Lo – Maximum external inductance

The maximum value of inductance that can be connected to the connection facilities of the apparatus without invalidating the type of protection.

Lo/Ro – Maximum external inductance to resistance ratio

Maximum value of ratio of inductance to resistance that can be connected to the external connection facilities of the electrical apparatus without invalidating intrinsic safety.

10.3 POWER PORT

This electrical port allows EXO to connect to a power supply and charge its battery pack while it continues to monitor an area. Currently, two G7 EXO accessories can be attached to this port:

1. **Trickle Charger** allows EXO to be hardwired directly to a power source
2. **Solar Panel** allows EXO to be powered in remote areas through solar energy.

⚠ WARNING: Cables attached to the power port are only intrinsically safe when properly set up with an electrical barrier.

Cable requirements

EXO's power port is fitted with a male M12 4 pin plug. Electrical cables with a female M12 4 pin receptacle are required to connect to this port.

10.3.1 INSTALLING ACCESSORIES

Install EXO power port accessories as shown in the following electrical diagram to ensure intrinsic safety.

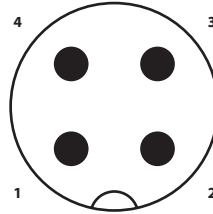

Diagram 10.3.1
Power port schematic diagram

Male plug
Pin assignment M12 plug, 4-pos., A-coded, view plug side

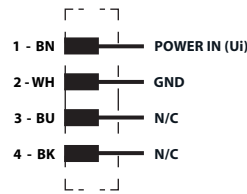
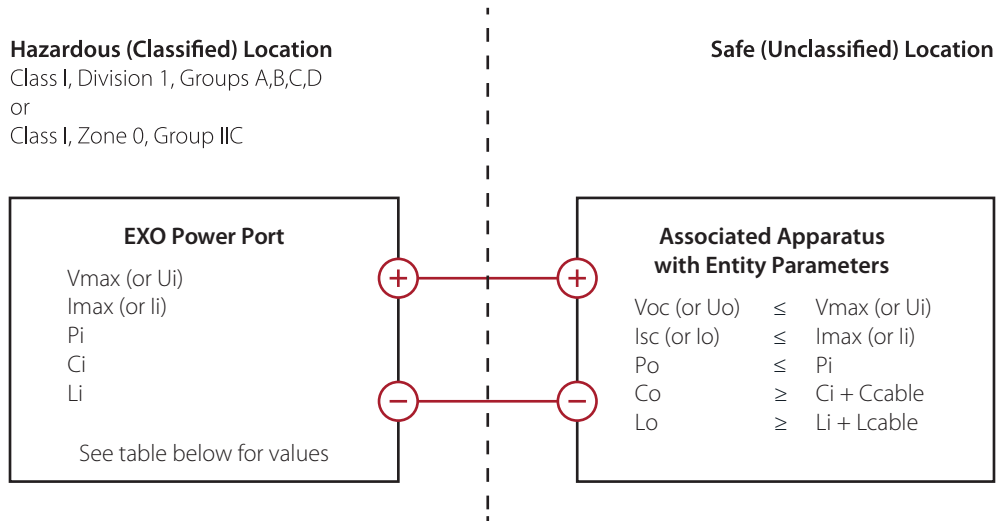

Diagram 10.3.2
Power port circuit diagram

Contact assignment of the M12 plug and M12 receptacles

Diagram 10.3.3

Power port parameters



Power port input entity parameters

Terminal	U _i	V _{min}	I _i	P _i	C _i	L _i
Power port	18Vdc	10Vdc	500mA	5300mW	0F	12.48uH

10.4 A/B INTERFACE PORTS

When safety notifications are triggered on EXO, A/B interface ports act as switches by sending ON or OFF signals to connected accessories. Ask your Blackline Safety distributor or sales representative for a list of G7 EXO accessories that attach to the A/B interface ports.

High gas threshold

If a high gas threshold is reached, port A will turn ON. Any device connected to port A will be active. The port will turn OFF when gas levels go back to normal on EXO.

Low gas threshold

If a low gas threshold is reached, port B will turn ON. Any device connected to port B will be active. The port will turn OFF when gas levels go back to normal on EXO.

Cable requirements

Both of EXO's A/B interface ports are fitted with a female M12 4 pin receptacle. Electrical cables with a male M12 4 pin plug are required to connect to these ports.

EXO versions and serial numbers

Two versions of the EXO have different output port parameters. High output EXOs have serial numbers 35880xxxxx, 35882xxxxx, or 35884xxxxx. Low output EXOs have serial numbers 35881xxxxx, 35883xxxxx, or 35885xxxxx.

Diagram 10.4.3

Interface port parameters – Low-side switch

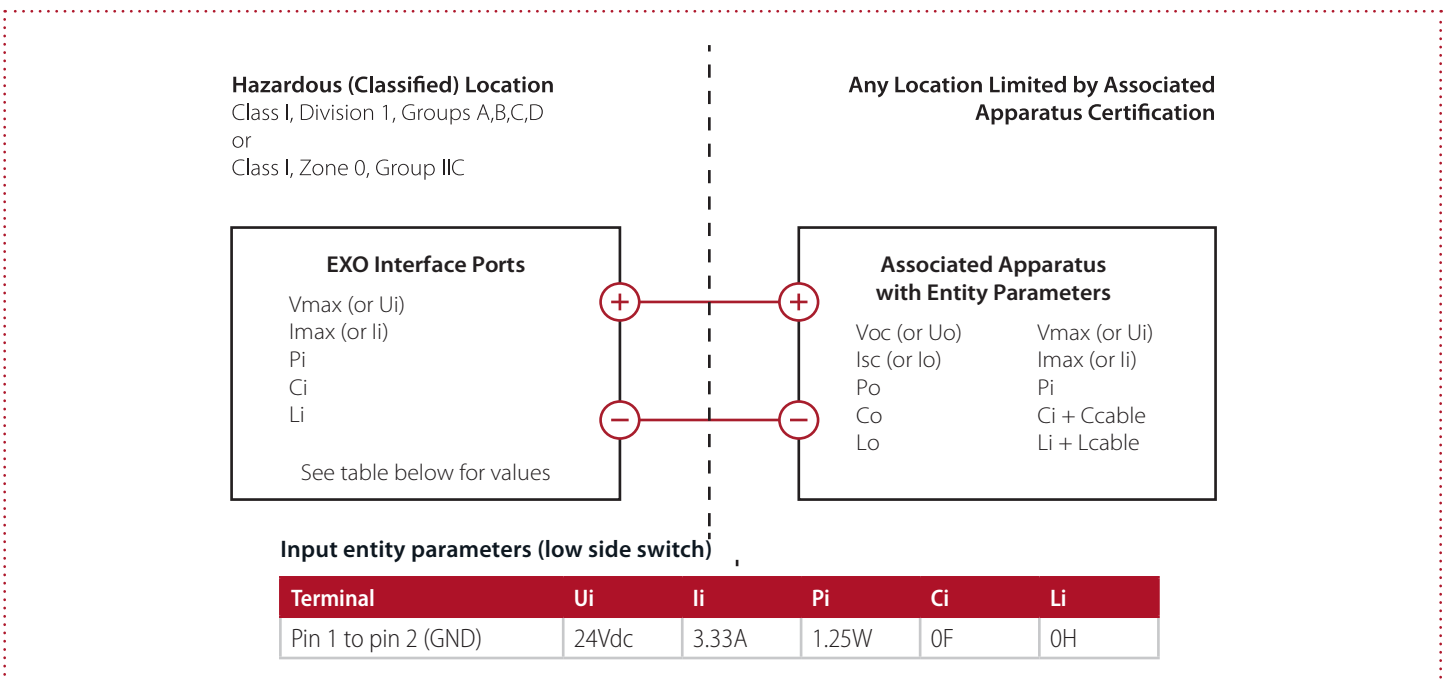

10.4.1 INSTALLING ACCESSORIES

Install EXO interface port accessories as shown in the following electrical diagrams to ensure intrinsic safety.

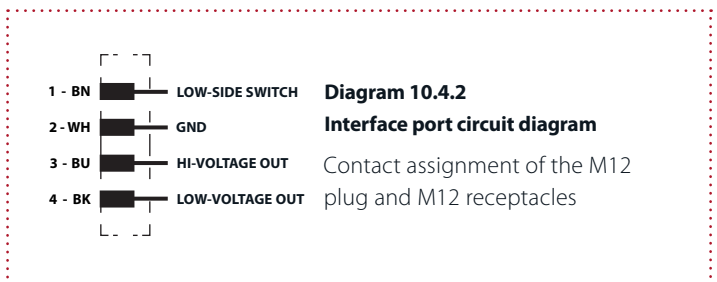
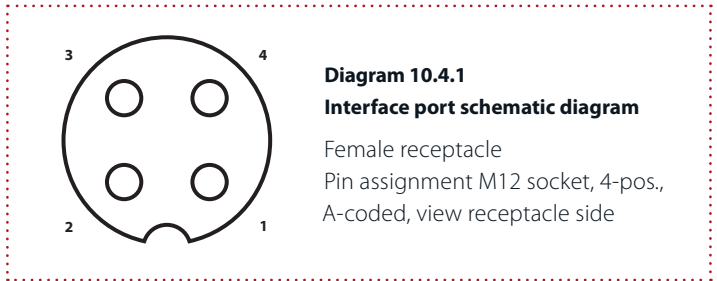
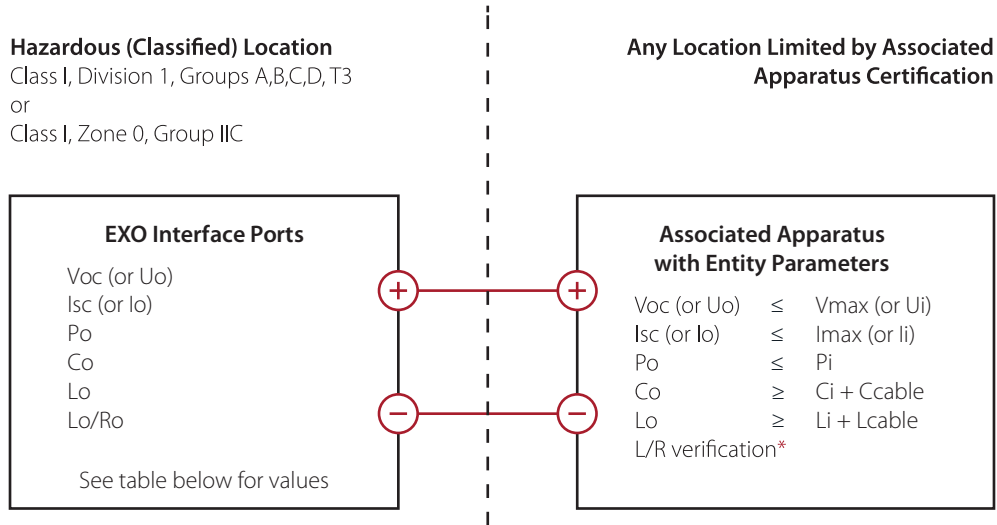

Diagram 10.4.4
Interface port parameters – pins 3 & 4



Output entity parameters - high output models (G7EXO-NA2 serial# 35880xxxxx, G7EXO-EU2 serial# 35882xxxxx, G7EXO-AZ2 serial# 35884xxxxx)

Terminal	Uo	Io	Po	Co	Lo	Lo/Ro*
Pin 3 to pin 2 (GND)	20.76Vdc	268mA	1.39W	0.194uF	495uH	6.39uH/Ω
Pin 4 to pin 2 (GND)	4.94Vdc	108mA	97mW	100uF	3.05mH	91.68uH/Ω

Output entity parameters - low output models (G7EXO-NA2 serial# 35881xxxxx, G7EXO-EU2 serial# 35883xxxxx, G7EXO-AZ2 serial# 35885xxxxx)

Terminal	Uo	Io	Po	Co	Lo	Lo/Ro*
Pin 3 to pin 2 (GND)	20.76Vdc	93mA	0.479W	0.194uF	4.1mH	18.2uH/Ω
Pin 4 to pin 2 (GND)	3.6Vdc	1.21A	3W	1000uF	24.3uH	21.9uH/Ω

* Li may be greater than Lo and the cable length restrictions due to cable inductance (Lcable), and can be ignored if both of the following conditions are met:

$$\begin{aligned} \text{Lo/Ro} &\geq \text{Li/Ri} \\ \text{Lo/Ro} &\geq \text{Lcable/Rcable} \end{aligned}$$

Diagram 10.4.5

Interface port functional parameters

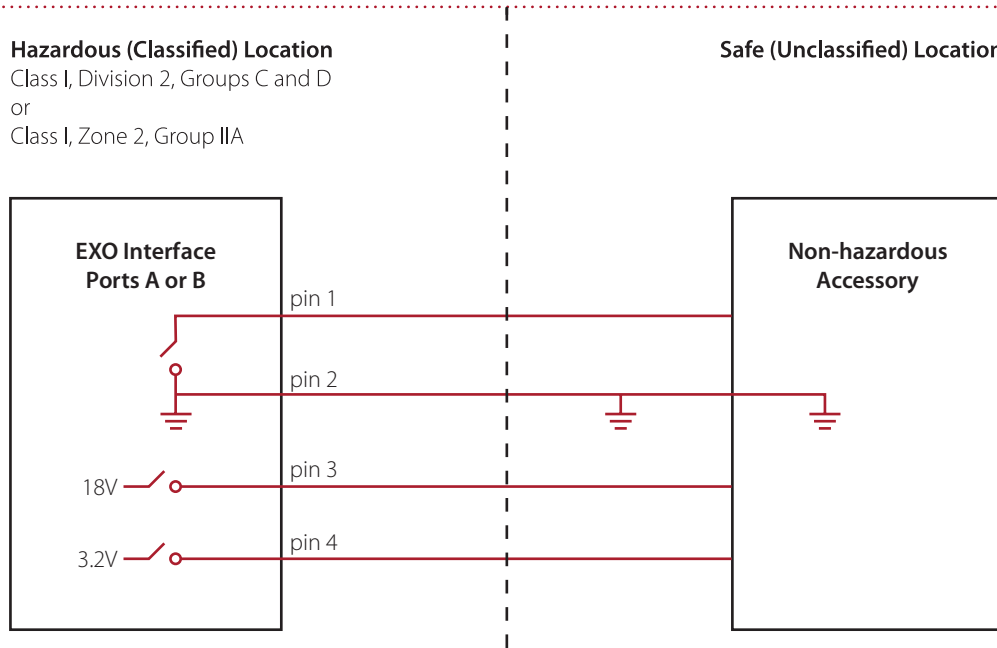

Functional output parameters for interface ports A and B - high output models
 (G7EXO-NA2 serial# 35880xxxxx, G7EXO-EU2 serial# 35882xxxxx, G7EXO-AZ2 serial# 35884xxxxx)

Terminal	U _o	I _o [†]	P _o [†]	C _o	L _o
Pin 3 to pin 2 (GND)	18Vdc	268mA	850mW	0.194uF	495uH
Pin 4 to pin 2 (GND)	3.2Vdc	32mA	25mW	100uF	23.9uH

Functional output parameters for interface ports A and B - low output models
 (G7EXO-NA2 serial# 35881xxxxx, G7EXO-EU2 serial# 35883xxxxx, G7EXO-AZ2 serial# 35885xxxxx)

Terminal	U _o	I _o [†]	P _o [†]	C _o	L _o
Pin 3 to pin 2 (GND)	18Vdc	48mA	479mW	0.194uF	4.1mH
Pin 4 to pin 2 (GND)	3.2Vdc	1000mA	3.0W	1000uF	24.2uH

[†] I_o and P_o will be reduced if both pin 3 and pin 4 are utilized simultaneously.

Functional input parameters (low side switch)
for interface ports A and B

Terminal	U _i	I _i	P _i	C _i	L _i
Pin 1 to pin 2 (GND)	24Vdc	3.33A	1.25W	0F	0H

Diagram 10.4.6

Interface port functional parameters with barriers

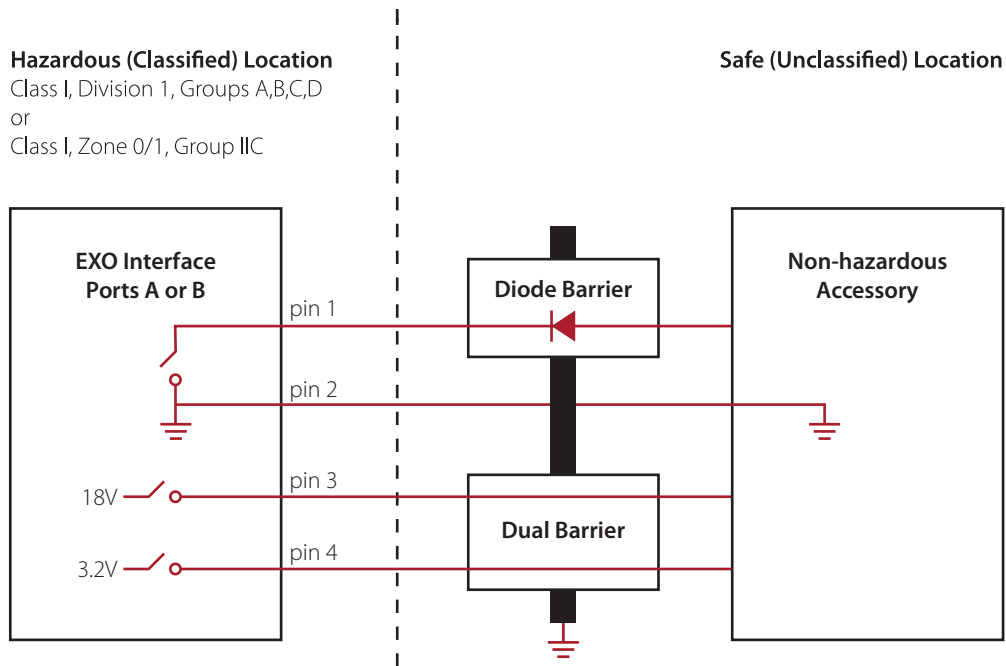

NOTE: A barrier is required for each interface port. The diode barrier and dual barrier can be individual units or a joint unit.

Functional output parameters for interface ports A and B - high output models
 (G7EXO-NA2 serial# 35880xxxxx, G7EXO-EU2 serial# 35882xxxxx, G7EXO-AZ2 serial# 35884xxxxx)

Terminal	U _o	I _o [†]	P _o [†]	C _o	L _o
Pin 3 to pin 2 (GND)	18Vdc	268mA	850mW	0.194uF	495uH
Pin 4 to pin 2 (GND)	3.2Vdc	32mA	25mW	100uF	23.9uH

Functional output parameters for interface ports A and B - low output models
 (G7EXO-NA2 serial# 35881xxxxx, G7EXO-EU2 serial# 35883xxxxx, G7EXO-AZ2 serial# 35885xxxxx)

Terminal	U _o	I _o [†]	P _o [†]	C _o	L _o
Pin 3 to pin 2 (GND)	18Vdc	48mA	479mW	0.194uF	4.1mH
Pin 4 to pin 2 (GND)	3.2Vdc	1000mA	3.0mW	1000uF	24.2uH

[†] I_o and P_o will be reduced if both pin 3 and pin 4 are utilized simultaneously.

Functional input parameters (low side switch)
for interface ports A and B

Terminal	U _i	I _i	P _i	C _i	L _i
Pin 1 to pin 2 (GND)	24Vdc	3.33A	1.25W	0F	0H

11 OVER-THE-AIR (OTA) FIRMWARE UPDATES

To offer new features, Blackline Safety periodically releases over-the-air (OTA) firmware updates. OTA firmware updates are only available when EXO is on a cellular network. Firmware updates have two steps:

1. Automatic download
2. Automatic installation

Automatic download

When a firmware update is released, EXO will gradually download the update whenever it is on and connected to a cellular network. EXO will be ready to install the firmware update when the download is complete. This will not interfere with normal EXO use.

Automatic installation

The completely downloaded update will automatically be installed the next time EXO is powered on. This installation will add 30-60 seconds to the startup sequence.

When the green light is solid and EXO is connected, it will automatically power down. The top lights will then flash red and yellow and the device will be unresponsive. After 30-60 seconds, EXO will power back up and display the new firmware version it has downloaded.

Once firmware is installed, EXO will continue to monitor as usual.

▲WARNING: EXO will NOT monitor during the installation process.

Specific information about new updates can be found at support.blacklinesafety.com. If you have any questions, please contact our Customer Care team.

12 SUPPORT

12.1 LEARN MORE

Visit support.blacklinesafety.com to find more support and training materials for EXO.

12.2 CUSTOMER CARE

For technical support, please contact our Customer Care team.

North America (24 hours)

Toll Free: 1-877-869-7212 | support@blacklinesafety.com

United Kingdom (8am-5pm GMT)

+44 1787 222684 | eusupport@blacklinesafety.com

International (24 hours)

+1-403-451-0327 | support@blacklinesafety.com

13 SPECIFICATIONS

13.1 DETAILED SPECIFICATIONS

Functional settings

SOS latch: Pull latch to trigger SOS alert

Low-battery: Configurable threshold

Connection lost: Configurable time period

Two-way messages: Custom messages and 10 preconfigured sent to monitoring personnel

Maintenance code: Configurable 4 digits

Push-to-talk: Send and receive voice messages to other G7 devices

Gas cartridge features

High gas alert

Low gas warning alarm

Under limit (UL)

Over limit alerts (OL)

Bump test and calibration notification

Bump test and calibration failure

Size & weight

Material: Rugged housing built from aluminum, plastic and rubberized bumpers

Size: 385 mm x 188 mm x 220 mm (15.1" x 7.4" x 8.7")

Weight: 12.25Kg 27 lbs

User interface

Display: 4.4" diagonal, 480 by 640 pixel, eight-colour active matrix liquid crystal display (LCD)

Menu system: Driven by three-button keypad,

Power button: On/Off

SOS latch: Send SOS alert

Multi-language support: EN, FR, ES, DE, IT, NL, PT

User notification

Green connectivity light: Blinking (powered), continuous (connected)

360-degree visible yellow and red lights

Yellow light: Warning alarms

Red light: Alerts

Blue LiveResponse™ indicator light: Confirmation that a monitoring team has acknowledged an alert

Cellular wireless radio

Wireless coverage: 100 countries, 200 wireless carriers

North America: 3G/4G radio; 3G UMTS bands 2 and 5; 4G bands 2, 4 and 5

International: 2G/4G radio; 2G GSM bands E-GSM and PCS; 4G bands 3, 7 and 20

Asia Pacific: 3G/4G radio; 3G UMTS band 1;

4G bands 3, 8 and 28

Antenna: Internal

Satellite module

User-upgradeable satellite module allows EXO to connect to the Iridium satellite network for remote areas outside of cellular connectivity.

Optional module: Yes

Network: Iridium, global coverage

Radio: 1621 MHz, 2 Watts

Antenna: Internal

Wireless updates

Device configuration changes: Yes

Device firmware upgrade (OTA): Yes

Location technology

Multi-constellation: GPS/QZSS, Galileo, Beidou

Receiver type: 72-channel

Assisted-GNSS: Yes

GNSS Accuracy: 5 m (16 feet), CEP 50%, 24 hours static

G7 EXO Pump

Number of pump channels: 4

Sampling period per channel: Adjustable

Tube length per channel: Up to 30 m (100 ft)

Power & battery

Rechargeable battery capacity: 144 Ah (LiFePO₄)

Battery life in diffusion mode: 100 days at 20°C (68°F),

LEL-IR, H₂S, CO and O₂ config.

Battery life in pump mode: 30 days at 20°C (68°F),

LEL-IR, H₂S, CO and O₂ config.

Charge time: ~12 hr

Intrinsically safe power port: Yes, supports G7 EXO continuous operation

A/B interface ports

Intrinsically safe, highly configurable external signal ports designed to integrate with external alarms and electrical systems

Four pins per interface port

Pin 1: Low side switch

Voc=24Vdc, Isc=3.33A, Co=0F, Lo=0H

Pin 2: Ground

Pin 3: High voltage out

Voc=18Vdc, Isc=268mA, Co=0.194uF, Lo=495uH

Pin 4: Low voltage out

Voc=3.2Vdc, Isc=32mA, Co=100uF, Lo=23.9uH

Environmental

Storage temperature: -40°C to 60°C (-40°F to 140°F)

Operating temperature: -20°C to 50°C (-4°F to 122°F)

Charging temperature: 0°C to 45°C (32°F to 113°F)

Ingress Protection: Designed to meet IP65

Approvals

RoHS, CE, RCM

Canada & USA: Class I Division 1 Group A,B,C,D T3;

Class I Zone 0 AEx ia IIC T3; Ex ia IIC T3 Ga

IECEX: Ex ia IIC T3 Ga

ATEX: Ex ia IIC T3 Ga

LEL: CSA C22.2 No.152; ISA 12.13.01

FCC ID: W77EXO **IC:** 8255A-EXO

Contains:

FCC ID: XPY1EIQ24NN, Q639603N

IC: 8585A-1EIQ24NN, 4629A-9603N

Warranty

G7 EXO area monitor: three-year hardware warranty, extended warranty available

Blackline complete lease option: provides comprehensive warranty for full term

Blackline Live web application

Cloud-hosted safety monitoring web application is highly customizable for every customer requirement. Includes live map, employee address book, user roles, alert management, device configurations, alert setups and reporting

13.2 GAS SENSOR SPECIFICATIONS

Gas	Sensor type	Range	Resolution
Ammonia (NH ₃)	Electrochemical	0–100 ppm	0.1 ppm
High-range ammonia (NH ₃)	Electrochemical	0–500 ppm	1 ppm
Carbon monoxide (CO)	Electrochemical	0–500 ppm	1 ppm
High-range carbon monoxide (CO)	Electrochemical	0–2000 ppm	5 ppm
Hydrogen resistant carbon monoxide (CO-H)	Electrochemical	0–500 ppm	1 ppm
Carbon dioxide (CO ₂)	NDIR	0–50,000 ppm	50 ppm
Chlorine (Cl ₂)*	Electrochemical	0–20 ppm	0.1 ppm
Chlorine dioxide (ClO ₂)*	Electrochemical	0–2 ppm	0.01 ppm
COSH (CO & H ₂ S)	Electrochemical	0–500 ppm CO, 0–100 ppm H ₂ S	1 ppm CO, 0.1 ppm H ₂ S
Hydrogen (H ₂) (UK/EU only)	Electrochemical	0–40,000 ppm	1% LEL (400 ppm H ₂)
Hydrogen cyanide (HCN)	Electrochemical	0–30 ppm	0.1 ppm
Hydrogen sulphide (H ₂ S)	Electrochemical	0–100 ppm	0.1 ppm
High-range hydrogen sulphide (H ₂ S)	Electrochemical	0–500 ppm	0.5 ppm
LEL-infrared (LEL-IR)	NDIR	0–100% LEL	1% LEL
LEL-molecular property spectrometer (LEL-MPS)	MPS	0–100% LEL	0.1% LEL
LEL-pellistor (LEL-P)	Catalytic bead	0–100% LEL	1% LEL
Nitrogen dioxide (NO ₂)	Electrochemical	0–50 ppm	0.1 ppm
Oxygen (O ₂)	Pumped electrochemical	0–25% vol	0.1% vol
Photoionization (PID)	PID	0–4,000 ppm	Dynamic resolution**, 0.1 ppm
Sulfur dioxide (SO ₂)	Electrochemical	0–100 ppm	0.1 ppm

*Sensor does not work with G7 EXO Pump

** Dependent on correction factor

NOTE: Check with Blackline for approval status. All specifications subject to change.

14 LEGAL NOTICES AND CERTIFICATIONS

14.1 LEGAL NOTICES

Information in this document is subject to change without notice. This document is provided “as is” and Blackline Safety Corp. (“Blackline”) and its affiliated companies and partners assume no responsibility for any typographical, technical or other inaccuracies in this document. Blackline reserves the right to periodically change information that is contained in this document. However, Blackline makes no commitment to provide any such changes, updates, enhancements or other additions to this document to you in a timely manner or at all.

Copyright © 2020 Blackline Safety Corp. All rights reserved.

Except as expressly provided herein, no part of this manual may be reproduced, copied, transmitted, disseminated, downloaded, or stored in any storage medium, for any purpose without the express prior written consent of Blackline Safety Corp (“Blackline”). Blackline hereby grants permission to download a single copy of this manual onto some form of electronic storage medium to be viewed and to print one copy of this manual or any revision hereto, provided that such electronic or printed copy of this manual must contain the complete text of this copyright notice. Further, any unauthorized commercial distribution of this manual or any revision hereto is strictly prohibited.

The Blackline, Alert, Locate, Respond, Families of related marks, images and symbols, including Blackline, G7, G7c, G7x, G7 EXO, LiveResponse, Loner, LonerIS, Loner IS+, Loner M6, Loner M6i, Loner Mobile, Loner 900, and SureSafe are the exclusive properties and trademarks of Blackline Safety Corp. All other brands, product names, company names, trademarks and service marks are the properties of their respective owners.

Warranty

Your G7 EXO device is warranted against defects in materials and workmanship for up to three years from date of purchase. For further details regarding your Blackline warranty, please refer to your terms and conditions of service.

FCC Compliance

This device complies with part 15 of the FCC Rules. Operation is subject to the following two conditions: (1) This device may not cause harmful interference, and (2) this device must accept any interference received, including interference that may cause undesired operation.

NOTE: The grantee is not responsible for any changes or modifications not expressly approved by the party responsible for compliance. Such modifications could void the user’s authority to operate the equipment.

NOTE: This equipment has been tested and found to comply with the limits for a Class B digital device, pursuant to part 15 of the FCC Rules. These limits are designed to provide reasonable protection against harmful interference in a residential installation. This equipment generates, uses and can radiate radio frequency energy and, if not installed and used in accordance with the instructions, may cause harmful interference to radio communications. However, there is no guarantee that interference will not occur in a particular installation. If this equipment does cause harmful interference to radio or television reception, which can be determined by turning the equipment off and on, the user is encouraged to try to correct the interference by one or more of the following measures:

- Reorient or relocate the receiving antenna.
- Increase the separation between the equipment and receiver.
- Connect the equipment into an outlet on a circuit different from that to which the receiver is connected.
- Consult the dealer or an experienced radio/TV technician for help.

This device is compliant with radio frequency radiation exposure regulations for mobile devices. As such, a separation of at least 20 cm must be normally maintained between the device and nearby persons.

Industry Canada Compliance

This device complies with Industry Canada licence-exempt RSS standard(s). Operation is subject to the following two conditions: (1) this device may not cause interference, and (2) this device must accept any interference, including interference that may cause undesired operation of the device.

Notification d’Industrie Canada

Ce dispositif est conforme au(x) format(s) RSS libre(s) d’Industrie Canada. Son fonctionnement est assujéti aux deux conditions suivantes : (1) Cet appareil ne peut causer d’interférences nuisibles, et (2) cet appareil doit accepter toute interférence reçue, y compris les interférences pouvant provoquer un mauvais fonctionnement du dispositif.

Warning

Do not operate Blackline Safety products where you are not able to safely operate your mobile/cellular phone.

Electrical equipment may be hazardous if misused. Operation of this product, or similar products, must always be supervised by an adult. Do not allow children access to the interior of any electrical product and do not permit them to handle any cables.

Do not operate or store Blackline products outside their specified operating or storage temperatures. Consult **13** for more information.

Blackline products may contain an internal lithium-ion battery pack. Seek advice from your local electronics recycling authority regarding the disposal of your device. Do not dispose of Blackline products in your household trash.

14.2 INMETRO CERTIFICATION

INMETRO – Certificate BRA 22.GE0002X, Ex ia IIC T3 Ga

14.3 INTRINSICALLY SAFE CERTIFICATION

Intrinsically Safe

This device is certified Intrinsically Safe for use in Class I Division 1 Groups A,B,C,D,T3; Ex ia IIC T3 Ga; Class I Zone 0 AEx ia Group IIC T3 Ga hazardous (classified) locations.

MC 267256

UL 60079

Class I Division 1 Groups A,B,C,D;T3

Class I Zone 0 AEx ia IIC T3 Ga

CAN/CSA C22.2 No. 60079

Ex ia IIC T3 Ga



IECEX/ATEX: IECEX SIR 20.0022X; Sira 20ATEX2004X

IEC 60079; EN 60079

Ex ia IIC T3 Ga



$-20^{\circ}\text{C} \leq T_{\text{amb}} \leq +50^{\circ}\text{C}$

Base unit P/N "G7EXO-#" (# = NA2, EU2, AZ2, or VZ2)

Caution

For safety reasons this equipment must be operated and serviced by qualified personnel only. High off-scale readings may indicate explosive concentration.

The equipment shall only be charged when in the non-hazardous area using a charger specifically supplied for use with the unit (for example part number JAC2504L-XX, manufactured by Schauer Battery Chargers), approved as SELV or Class 2 equipment against IEC 60950, IEC 61010-1 or an equivalent IEC standard. The maximum voltage and current from the charger shall not exceed 5Vdc and 25A respectively.

Consult with your organization's safety professional for further information regarding the topic of intrinsic safety and any policies, procedures, facilities, or locations within facilities that may be related to intrinsic safety.

Sécurité intrinsèque

Cet appareil est certifié à sécurité intrinsèque pour l'usage en classe I division 1 groupe A,B,C,D T3; Ex ia IIC T3 Ga; classe I zone 0 AEx ia groupe IIC T3 Ga dans les lieux classés comme dangereux.

Standards:

CAN/CSA C22.2 No. 60079-0: 2019

CAN/CSA C22.2 No. 60079-11: 2014

C22.2 No. 152 - M1984 (R2011)

UL 913, Eighth Edition

UL 60079-0: Sixth Edition

UL 60079-11: Sixth Edition

ANSI/ISA 12.13.01: 2000

EN 60079-0: 2012/A11:2013

EN 60079-11: 2012

IEC 60079-0: 2011 6th Edition

IEC 60079-11: 2011 6th Edition

Attention

Pour des raisons de sécurité, cet équipement doit être utilisé, entretenu et réparé uniquement par un personnel qualifié. Des lectures supérieures à l'échelle peuvent indiquer des concentration explosives.

L'équipement ne doit être chargé que dans la zone non dangereuse à l'aide d'un chargeur spécifiquement fourni pour l'utilisation avec l'appareil (par exemple, la référence JAC2504L-NA, fabriquée par Schauer Battery Chargers) SELV ou Classe 2 selon IEC 60950, IEC 61010-1 ou une norme IEC équivalente. La tension et le courant maximum du chargeur ne doivent pas dépasser respectivement 5Vdc et 25A.

S'il vous plaît consulter professionnel de la sécurité de votre organisation pour de plus amples informations concernant le sujet de la sécurité intrinsèque et les politiques, les procédures, les installations, ou emplacements au sein des établissements qui peuvent être liés à la sécurité intrinsèque.

blacklinesafety

www.BlacklineSafety.com