

Optical Detector

Multisensor Detector

Heat Detector

Mounting Bases



2

orbis®

...conventional detectors from Apollo

orbis® is a range of conventional detectors which has been developed and tested to create advantages for fire engineers and installers, as well as owners and users of buildings.

Orbis is a range with modern styling and a mounting base that saves installation time. It is electrically compatible with Apollo Series 65 and previous ranges of conventional detector (see Technical Data).

Orbis is a demonstration of Apollo's commitment to the market for high quality conventional detectors for use in small to medium size installations. In developing this range Apollo has put ease of installation and reliability in daily operation at the forefront of considerations. The attractive

and compact design means that Orbis will blend in well with all architectural styles.

Orbis is manufactured in Apollo's factory near Portsmouth, England

Orbis has been tested and approved to the following standards:

EN54-7: 2000 + A1: 2002
optical smoke detector

EN 54-7: 2000 + A1: 2002 &
CEA 4021: 2003-07
multisensor smoke detector

EN 54-5: 2000 + A1: 2002
heat detector

Detectors have been declared as being compliant with the essential requirements of the EMC Directive 2004/108/EEC and the Construction Products Directive 89/106/EEC

CONTACT POINTS FOR ENQUIRIES AND HELP

Technical queries
techsales@apollo-fire.co.uk

Resources (literature, photos)
marketing@apollo-fire.co.uk

Sales enquires
sales@apollo-fire.co.uk

Phone number for all departments
+44 (0)23 9249 2412

Fax for all departments
+44 (0)23 9249 2754

Website
www.apollo-fire.co.uk

ORBIS TABLE OF CONTENTS

Contact points for enquiries and help..... 2

Range of Products..... 4

Features of Orbis®..... 4

Choosing a detector: questions and answers 4

Orbis Optical Smoke Detector 6

Where to use optical smoke detectors..... 6

How does the Orbis optical detector work?..... 7

Environmental performance..... 7

Technical Data..... 7

Orbis Multisensor Smoke Detector 8

Where to use multisensor smoke detectors..... 8

How does the Orbis multisensor detector work? . 8

Environmental performance..... 8

Technical Data..... 9

Orbis Heat Detector.....10

Where to use heat detectors10

Choosing the correct class of heat detector10

How do Orbis heat detectors work?.....11

Environmental performance.....11

Technical Data.....11

Orbis TimeSaver Base®12

Installing Orbis.....12

Fitting Orbis detector heads.....13

Orbis Features—LED Status13

TimeSaver LX14

Relay Base.....14

Sav-Wire Base14

Heater Base.....14

Orbis Adaptor14

Commissioning made easy.....14

StartUp15

What StartUp indicates15

FasTest®15

Smoke or Heat Testing.....15

Maintenance and Servicing15

DirtAlert.....15

Approvals and Regulatory Compliance15

EU Directives.....15



Assessed to ISO 9001: 2008
Certificate number 010



Information in this guide is given in good faith, but Apollo Fire Detectors cannot be held responsible for any omissions or errors. The company reserves the right to change specifications of products at any time and without prior notice.

© Apollo Fire Detectors Limited 1999-2010





orbis®

Range of Products

Orbis comprises an optical smoke detector, a mutisensor smoke detector, heat detector types A1R, A1S, A2S, BR, BS, CR and CS, a standard electronics-free base, a diode base, deep base, a relay base, heater base and a Sav-Wire base.

FEATURES OF ORBIS™

Orbis incorporates entirely new designs, both mechanical and electronic. The purpose of Orbis is to make installation, commissioning and maintenance quicker, enhance the reliability of detection and reduce the incidence of false alarms. Orbis features:

- TimeSaver Base® designed for fast installation
- StartUp™ for fast commissioning
- FasTest® reduces maintenance time
- automatic drift compensation with DirtAlert® warning to easily identify dirty detectors
- SensAlert® which indicates that the detector is not operating properly
- wide voltage and operating temperature ranges
- optical sensor designed for high reliability and reduced false alarm incidence
- mutisensor smoke detector for detecting fast-burning fires
- flashing LED option

Orbis features and part numbers may vary according to territory. Please refer to your price list or distributor for individual part numbers.

Should I use optical detectors to detect smoke in all applications?

Optical detectors have long been recommended as good general purpose smoke detectors. Laboratory tests have been carried out to compare the performance of optical detectors in the standard test fires described in the European standard EN54.

The results of these tests are given in Fig 1. The graph shows the acceptable response in terms of smoke density which is given as 'm' on the y axis. Detectors must respond before the end of test which is an 'm' = value of 2. The performance of Orbis detectors is given as a solid line which shows how evenly the optical detectors respond to the test fires.

If detectors respond too quickly (the lower shaded portion of the graph) they may be too sensitive and hence likely to generate false alarms.

If detectors respond too slowly (the upper shaded portion) they are in danger of not changing to the alarm state before the end of test.

An even response in the centre is the ideal response.

When would I use a multisensor?

Multisensor smoke detectors have a heat sensing element which makes them more sensitive if a fire develops heat as well as smoke. This speeds up the response of the detector in certain fires where heat is generated rapidly, for instance in test fire TF5, which is an open, flaming liquid fire in which n-heptane is burned.

Multisensor smoke detectors are recommended for open flaming fire risks.

If there is any doubt as to whether an optical detector or a multisensor smoke detector should be used it is wise to fit a multisensor smoke detector.

Where would there be a need to install heat detectors?

Heat detectors should be used if it is not possible to use smoke detectors. This will be the case for example in kitchens and smoking areas and where normal industrial processes produce substances which could be mistaken for smoke by a smoke detector, eg, flour mills, textile mills or loading bays with diesel-engined vehicles.

The type of substance encountered here would cause frequent false alarms if smoke detectors were fitted, so a heat detector is used instead.

How are heat detectors classified?

EN54 classifies heat detectors according to the ambient temperature in which they will be working and according to whether they may be tested as 'static' detectors (changing to alarm at a preset temperature) or 'rate-of-rise' (changing to alarm at a preset increase of temperature).

Heat detectors may also be marketed without either classification; but then the detection characteristics are unknown.

All Orbis heat detectors are tested and classified as either static or rate-of-rise.

So what is the best way to choose a heat detector?

To make things easier we have produced a flow chart which is shown on page 10.

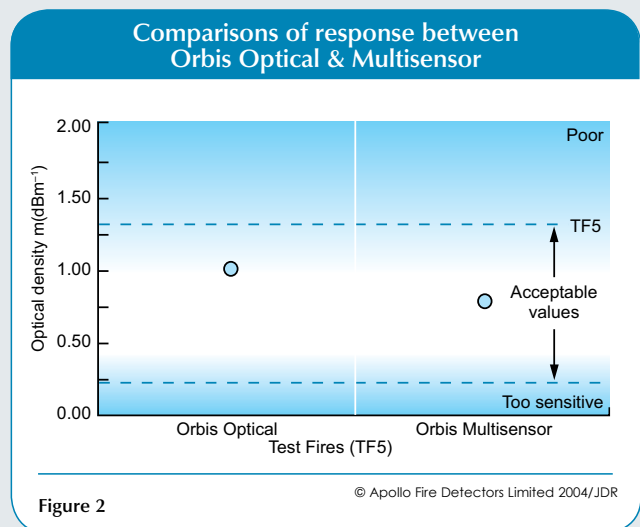
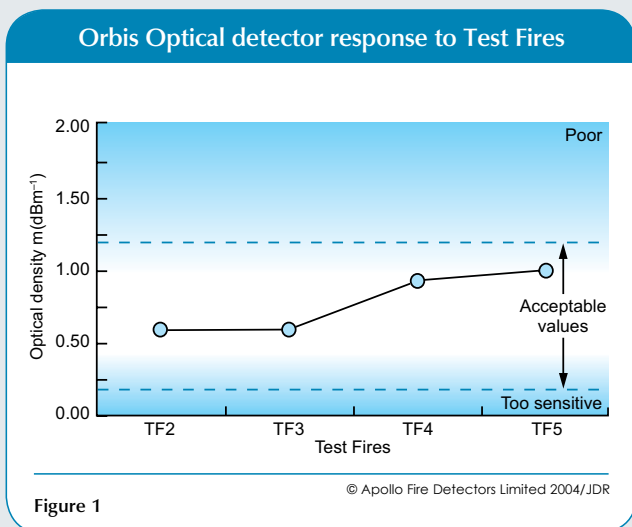



**ORBIS
OPTICAL
SMOKE
DETECTOR**

Part Number ORB-OP-12001-APO

WHERE TO USE OPTICAL SMOKE DETECTORS

Optical smoke detectors have always been recognised as good detectors for general use. They are regarded as particularly suitable for smouldering fires and escape routes.

The performance of Orbis optical detectors is good in black as well as in white smoke. In this respect Orbis is different from traditional optical smoke detectors which perform far better in white smoke than in black.

Orbis optical detectors are also designed to reduce significantly the incidence of false alarms through over-sensitivity to transient phenomena.

Orbis optical detectors are recommended for use as general purpose smoke detectors for early warning of fire in most areas.

ORBIS OPTICAL SMOKE DETECTOR

The sensing technology in the Orbis optical smoke detector is significantly different in design from previous optical detectors. A full description is given in the section 'How do orbis optical smoke detectors work?' but the advantages of this system and its associated algorithms are:

- improved sensitivity to black smoke
- compensation for slow changes in sensitivity
- extra confirmation of smoke before the alarm signal given

The algorithms are used to verify signals from the sensing chamber, to filter out transients and to decide when the detector should change to the alarm state.

All this combines to increase detection reliability and reduce false alarms.

HOW DOES THE ORBIS OPTICAL DETECTOR WORK?

Orbis operates on the well established light scatter principle. The remarkable optical design of the Orbis optical smoke detector allows it to respond to a wide spectrum of fires.

The sensing chamber of the Orbis optical smoke detector contains an optical sensor which measures back-scattered light as well as the more usual forward-scattered light. Sensitivity to black smoke is greatly improved.

The detector is calibrated so that Orbis is highly reliable in detecting fires but is much less likely to generate false alarms than earlier smoke detectors.

The stability of the detector—high reliability, low false alarm rate—is further increased by the use of algorithms to decide when the detector should change to the alarm state. This removes the likelihood of a detector producing an alarm as a result of smoke from smoking materials or from another non-fire source.

ENVIRONMENTAL PERFORMANCE

Orbis optical detectors operate over a broad range of voltages at extremes of temperature. Thus the operating voltage is 8.5V to 33V at -40° to +70°C, a unique achievement for a conventional smoke detector.

TECHNICAL DATA

All data is supplied subject to change without notice. Specifications are given at 23°C and 50% relative humidity unless otherwise stated.

DETECTOR OPERATING PRINCIPLES

Principle of detection: Photo-electric detection of light scattered by smoke particles over a wide range of angles. The optical arrangement comprises an infra-red emitter with a prism and a photo-diode at 90° to the light beam with a wide field of view. The detector's microprocessor uses algorithms to process the sensor readings.

Sampling frequency: Once every 4 seconds

ELECTRICAL

Supply voltage: 8.5—33V DC

Supply wiring: 2 wires, polarity sensitive

Maximum polarity reversal: 200ms

Power-up time: <20 seconds

Minimum 'detector active' voltage: 6V

Switch-on surge current at 24V: 95µA

Average quiescent current at 24V: 95µA

Alarm current: At 12 volts 20mA
At 24 volts 40mA

Alarm load: 600Ω

Holding voltage: 5—33V

Minimum holding current: 8mA

Minimum voltage to light alarm LED: 5V

Alarm reset voltage: <1V

Alarm reset time: 1 second

Remote output LED (-) characteristic: 1.2kΩ connected to negative supply

MECHANICAL

Material: Detector and base moulded in white polycarbonate.

Alarm Indicator: Integral indicator with 360° visibility (See Table 3 on page 13 for details of flash rate)

Dimensions: 97mm diameter x 31mm height
100mm diameter x 46mm height (in base)

Weight: Detector 75g
Detector in base 135g

ENVIRONMENTAL

Temperature: Operating and storage temperature -40°C to +70°C (no condensation or icing)

Humidity: 0% to 98% relative humidity (no condensation)

Wind speed: Unaffected by wind

Atmospheric pressure: Insensitive to pressure

IP rating to EN 60529: 1992*: 23D

Electromagnetic Compatibility: The detector meets the requirements of EN 61 000-6-3 for emissions and BS EN50 130-4 for susceptibility.

*The IP rating is not a requirement of EN 54 since smoke detectors have to be open in order to function. An IP rating is therefore not as significant as with other electrical products.



0832



ORBIS MULTISENSOR SMOKE DETECTOR

Part Number ORB-OH-13001-APO

WHERE TO USE MULTISENSOR SMOKE DETECTORS

Multisensor smoke detectors are recognised as good detectors for general use but are additionally more sensitive to fast burning, flaming fires—including liquid fires—than optical detectors.

They can be readily used instead of optical smoke detectors but should be used as the detector of choice for areas where the fire risk is likely to include heat at an early stage in the development of the fire.

As with Orbis optical smoke detectors the increased reliability of detection is combined with high immunity to false alarms.

The multisensor smoke detector has two sensors, one for smoke, one for heat and the alarm decision is derived from either sensor or a combination of both. The multisensor is a development of the Orbis optical detector described in the previous chapter and goes further in its capabilities of fire detection.

The optical sensor is identical to the one in the Orbis optical detector. Its sensitivity is, however, influenced by a heat sensing element which makes the detector more responsive to fast-burning, flaming fires.

ENVIRONMENTAL PERFORMANCE

The environmental performance of the multisensor detector is the same as that of the Orbis optical smoke detector.

TECHNICAL DATA

All data is supplied subject to change without notice.
Specifications are given at 23°C and 50% relative humidity unless otherwise stated.

DETECTOR OPERATING PRINCIPLES

Principle of detection: Photo-electric detection of light scattered by smoke particles over a wide range of angles. The optical arrangement comprises an infra-red emitter with a prism and a photo-diode at 90° to the light beam with a wide field of view. The detector's microprocessor uses algorithms to process the sensor readings. The heat sensing element increases the sensitivity of the detector as the temperature rises.

Sampling frequency: Once every 4 seconds

ELECTRICAL

Supply voltage: 8.5—33V DC

Supply wiring: 2 wires, polarity sensitive

Maximum polarity reversal: 200ms

Power-up time: <20 seconds

Minimum 'detector active' voltage: 6V

Switch-on surge current at 24V: 95µA

Average quiescent current at 24V: 95µA

Alarm current: At 12 volts 20mA
At 24 volts 40mA

Alarm load: 600Ω

Holding voltage: 5—33V

Minimum holding current: 8mA

Minimum voltage to light alarm LED: 5V

Alarm reset voltage: <1V

Alarm reset time: 1 second

Remote output LED (-) characteristic: 1.2kΩ connected to negative supply

MECHANICAL

Material: Detector and base moulded in white polycarbonate.

Alarm Indicator: Integral indicator with 360° visibility
(See Table 3 on page 13)

Dimensions: 97mm diameter x 42mm height
100mm diameter x 57mm height (in base)

Weight: Detector 80g
Detector in base 140g

ENVIRONMENTAL

Temperature: Operating and storage temperature -40°C to +70°C
(no condensation or icing)

Humidity: 0% to 98% relative humidity (no condensation)

Wind speed: Unaffected by wind

Atmospheric pressure: Insensitive to pressure

IP rating to EN 60529: 1992*: 23D

Electromagnetic Compatibility: The detector meets the requirements of EN 61 000-6-3 for emissions and BS EN50 130-4 for susceptibility.

*The IP rating is not a requirement of EN 54 since smoke detectors have to be open in order to function. An IP rating is therefore not as significant as with other electrical products.



0832



ORBIS HEAT DETECTOR

Part Number ORB-HT-11001-APO

WHERE TO USE HEAT DETECTORS

Heat detectors are used in applications where smoke detectors are unsuitable. Smoke detectors are used wherever possible since smoke detection provides earlier warning of fire than heat detection. There are, however, limits to the application of smoke detectors and these are described in the section 'features of Orbis' on page 4.

Heat detectors should be used if there is a danger of nuisance alarms from smoke detectors.

ORBIS HEAT DETECTOR

The Orbis range incorporates seven heat detector classes to suit a wide variety of operating conditions in which smoke detectors are unsuitable.

The European standard EN54-5:2001 classifies heat detectors according to the highest ambient temperature in which they can safely be used without risk of false alarm. The classes are identified by the letters A to G. (Class A is subdivided into A1 and A2.) In addition to the basic classification, detectors may be identified

by a suffix to show that they are rate-of-rise (suffix R) or fixed temperature (suffix S) types.

All heat detectors in the Orbis range are tested as static or rate-of-rise detectors and are classified as A1R, A1S, A2S, BR, BS, CR and CS.

Choosing a heat detector

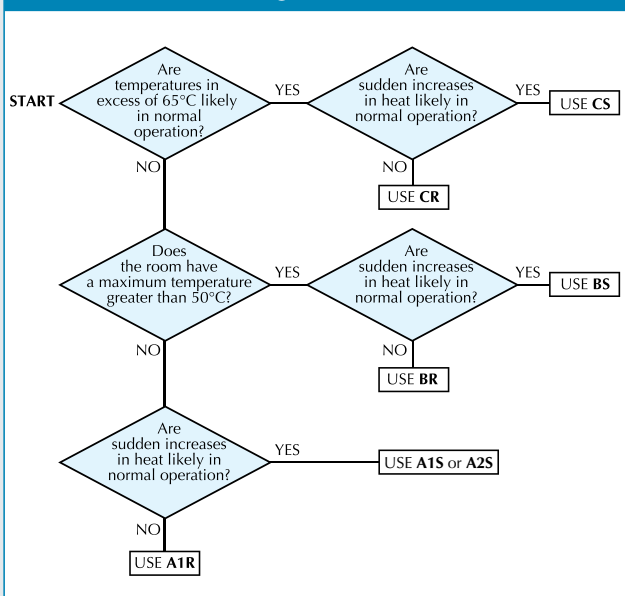

Fig. 3

© Apollo Fire Detectors Limited 2004-6/RHD

Heat Detector Response Modes

Class (EN54-5:2001)	Application Temperature		Static Response Temperature °C		
	Typical	Max	Min	Typ	Max
A1R	25	50	54	57	65
A1S	25	50	54	57	65
A2S	25	50	54	61	70
BR	40	65	69	73	85
BS	40	65	69	73	85
CR	55	80	84	90	100
CS	55	80	84	90	100

Table 1

CHOOSING THE CORRECT CLASS OF HEAT DETECTOR

Heat detectors have a wide range of response characteristics and the choice of the right type for a particular application may not always seem straightforward. It is helpful to understand the way that heat detectors are classified as explained earlier and to memorise a simple rule: use the most sensitive heat detector available consistent with avoiding false alarms.

In the case of heat detectors it may be necessary to take an heuristic approach, ie, trial and error, until the best solution for a particular site has been found. The flowchart (Fig. 3) will assist in choosing the right class of heat detector.

If the fire detection system is being designed to comply with BS 5839-1: 2002 heat detectors should be installed at heights of less than 12 metres with the exception of class A1 detectors, which can be installed at heights up to 13.5 metres.

HOW DO ORBIS HEAT DETECTORS WORK?

Orbis heat detectors have an open-web casing which allows air to flow freely across a thermistor which measures the air temperature every 2 seconds. A microprocessor stores the temperatures and compares them with pre-set values to determine whether a fixed upper limit—the alarm level—has been reached.

In the case of rate-of-rise detectors the microprocessor uses algorithms to determine how fast the temperature is increasing.

Static heat detectors respond only when a fixed temperature has been reached. Rate-of-rise detectors also have a fixed upper limit but they also measure the rate of increase in temperature. A fire might thus be detected at an earlier stage than with a static detector so that a rate-of-rise detector is to be preferred to a static heat detector unless sharp increases of heat are part of the normal environment in the area protected by the heat detector.

ENVIRONMENTAL PERFORMANCE

The environmental performance is similar to that of the Orbis optical smoke detector but it should be noted that heat detectors are designed to work at particular ambient temperatures (see Fig 3).

TECHNICAL DATA

All data is supplied subject to change without notice. Specifications are given at 23°C and 50% relative humidity unless otherwise stated.

DETECTOR OPERATING PRINCIPLES

Principle of detection: Measurement of heat by means of a thermistor.
Sampling frequency: Once every 4 seconds

ELECTRICAL

Supply voltage: 8.5—33V DC
Supply wiring: 2 wires, polarity sensitive
Maximum polarity reversal: 200ms
Power-up time: <20 seconds
Minimum 'detector active' voltage: 6V
Switch-on surge current at 24V: 95µA
Average quiescent current at 24V: 95µA
Alarm current: At 12 volts 20mA
 At 24 volts 40mA
Alarm load: 600Ω
Holding voltage: 5–33V
Minimum holding current: 8mA
Minimum voltage to light alarm LED: 5V
Alarm reset voltage: <1V
Alarm reset time: 1 second
Remote output LED (-) characteristic: 1.2kΩ connected to negative supply

MECHANICAL

Material: Detector and base moulded in white polycarbonate.
Alarm Indicator: Integral indicator with 360° visibility (See Table 3 on page 13 for details of flash rate)
Dimensions: 97mm diameter x 36mm height
 100mm diameter x 51mm height (in base)
Weight: Detector 70g
 Detector in base 130g

ENVIRONMENTAL

Temperature: Operating and storage (see table 1) -40°C to +70°C (no condensation or icing)
Humidity: 0% to 98% relative humidity (no condensation)
Wind speed: Unaffected by wind
Atmospheric pressure: Insensitive to pressure
IP rating to EN 60529: 1992*: 23D
Electromagnetic Compatibility: The detector meets the requirements of EN 61 000-6-3 for emissions and BS EN50 130-4 for susceptibility.

*The IP rating is not a requirement of EN 54 since smoke detectors have to be open in order to function. An IP rating is therefore not as significant as with other electrical products.



0832



**ORBIS
TIMESAVER
BASE®**

Part Number ORB-MB-00001-APO

INSTALLING ORBIS

Orbis has been designed to make installation fast and simple. Fig 4 shows the TimeSaver mounting base as it is seen from the installer’s point of view.

The E-Z fit fixing holes are shaped to allow a simple three-step mounting procedure:

- Fit two screws to the mounting box or surface
- Place the Orbis base over the screws and slide home
- Tighten the screws

The base offers two fixing centres at 51 and 60mm.

A guide on the base interior indicates the length of cable to be stripped. Five terminals are provided for the cables, four being grouped together for ease of termination.

The terminals are:

- positive IN
- positive OUT
- negative IN and OUT (common terminal)
- remote LED negative connection
- functional earth (screen)

The terminal screws are captive screws and will not fall out of the terminals. The base is supplied with the screws unscrewed in order to avoid unnecessary work for the installer.

The end-of-line resistor or active device should be connected between the OUT+ and COM– terminals.

If it is required that all detectors be fitted with their LEDs facing the same direction

the bases must be fitted to the ceiling observing the marking on the exterior which indicates the position of the LED.

The bases may be connected as shown in Fig 5 where remote LEDs, if required, are connected to the associated base.

Fig 6 shows how to connect one remote LED to more than one base so that an alarm in any of the detectors connected will switch the remote LED.

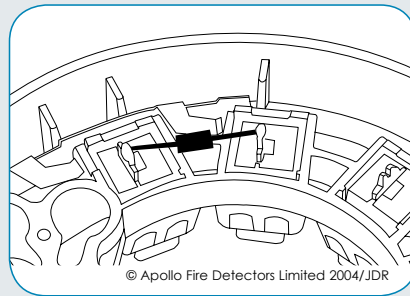

In many installations bases with diodes are specified in order that an active end-of-line device may be fitted. Diode bases are marked ‘OD’. Loop continuity testing is facilitated as there is a continuity device in the base. The continuity device enables power to pass through every base in a loop to ensure that each is connected correctly.

Once a detector is fitted to the base the continuity device is automatically locked permanently open so that the power flows through the detectors.

**FITTING ORBIS
DETECTOR HEADS**

When the bases have been installed and the system wiring tested, the detector circuits can be populated.

Two methods are suggested:

1. Apply power and fit the detectors one by one, starting at the base nearest the panel and working towards the end of the circuit. As each detector is powered up it will enter ‘StartUp’ and flash red (see next page for a full description of this feature). If the LED does not flash, check the wiring polarity on the base and ensure there is power across IN+ and COM–. If the LED is flashing yellow the detector is not operating correctly and may require maintenance or replacing (see DirtAlert and SensAlert® below and the section ‘Maintenance and servicing’ on page 15).
2. Fit all detectors to the circuit, apply power and check detectors by observing the LED status of each device. The StartUp feature lasts for 4 minutes so it may be necessary to reset or de-power the circuit to allow all detectors to be observed. The LED status is the same as method 1.

Product Description	Base Marking Code
Orbis TimeSaver Base	OB
Orbis TimeSaver LX Base	OL
Orbis TimeSaver Diode Base	OD
Orbis TimeSaver Relay Base	OR
Savwire Base	OS
TimeSaver Diode Base LX	DX
Orbis LX Base	XL
Orbis Timesaver Base - Deep	EB
Orbis Heater Base	HB

Table 2

Identifying Base Marking Codes

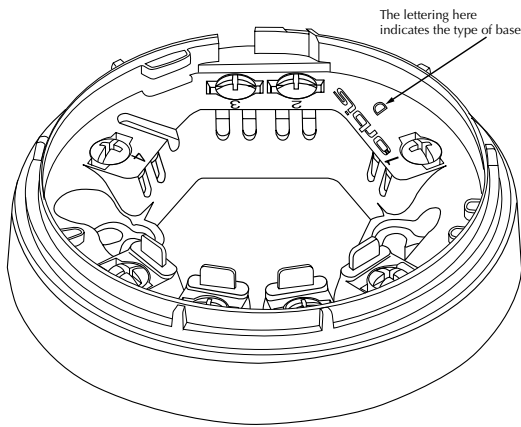

Figure 4

© Apollo Fire Detectors Limited 2004/JDR

TimeSaverBase®

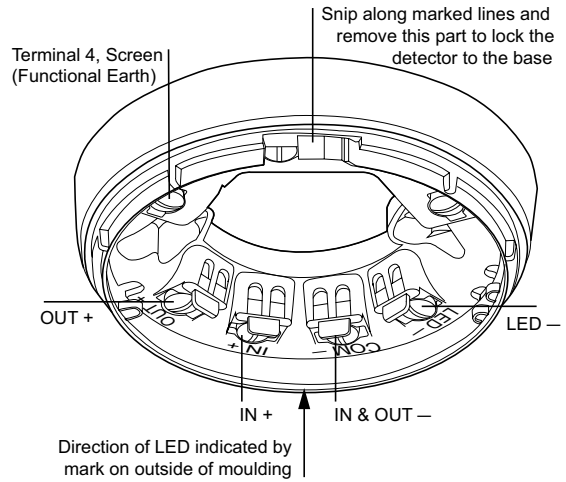

Figure 5

© Apollo Fire Detectors Limited 2004/JDR

Base wiring diagram

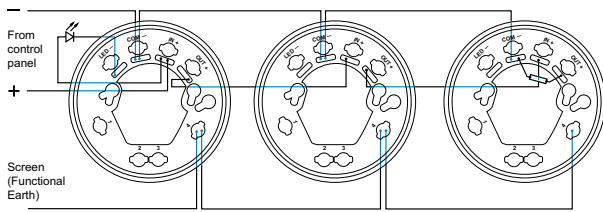

Figure 6

© Apollo Fire Detectors Limited 2004/JDR

3 bases wired with a common LED

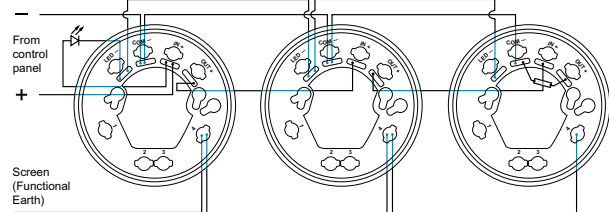

Figure 7

© Apollo Fire Detectors Limited 2004/JDR

Orbis features: LED status

Feature	Description of Feature	Red LED Status	Yellow LED Status
StartUp™	Confirms that the detectors are wired in the correct polarity	Flashes once per second	No Flash
FasTest®	Maintenance procedure, takes just 4 seconds to functionally test and confirm detectors are functioning correctly	Flashes once per second	No Flash
DirtAlert™	Shows that the drift compensation limit has been reached	No Flash	Flashes once per second in StartUp (Stops flashing when StartUp finishes)
SensAlert®	Indicates that the sensor is not operating correctly	No Flash	Flashes every 4 seconds (Flashes once per second in StartUp)
Normal Operation	At the end of StartUp and FasTest (without flashing LED as standard)	No Flash	No Flash
Flashing LED Version	Detector's red LED flashes in normal operation (at the end of FasTest)	Flashes every 4 seconds	No Flash

Table 3



Part Number ORB-MB-00002-APO

**ORBIS
TIMESAVER LX**



Part Number ORB-RB-10004-APO

**ORBIS
RELAY BASE®**



Part Number ORB-SW-10005-APO

**ORBIS
SAV-WIRE BASE®**

The TimeSaver Base® is a design that provides installers with an open working area with fixing holes shaped to allow a fast mounting procedure.

The relay base incorporates a single-pole voltage-free changeover contact for switching ancillary equipment. The maximum contact rating is 30V 1A.

When the detector changes to the alarm state, the relay is energised, causing the contact to change state. The contact will remain in this condition until the detector is reset.

A base is available which allows Orbis detectors to be used in 'Sav-Wire' detection and alarm systems. Care should be taken to connect Sav-Wire bases correctly as shown in fig 9.

The Orbis Heater base is designed to be used in cold climates where environmental conditions could result in either icing or condensation affecting the operation of detectors. It



Part Number ORB-HB-00020-APO

**ORBIS
HEATER BASE**

is recommended that the heater base be used in conjunction with either a Waterproof Base Cover or Deckhead Mounting Box to minimise moisture ingress.

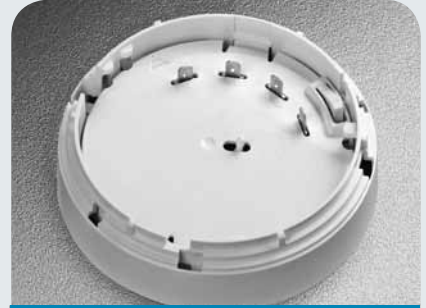

Part Number ORB-BA-10008-APO

**ORBIS
ADAPTOR**

An adaptor can be used to enable Orbis detectors to be fitted to Series 60/65 bases.

14

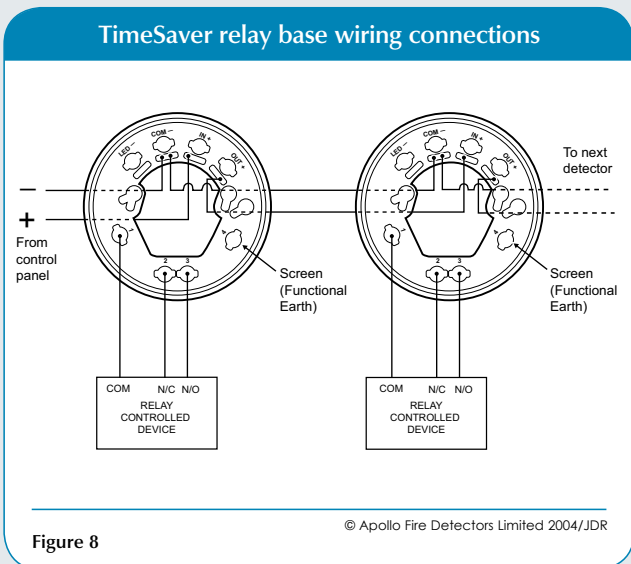

Figure 8

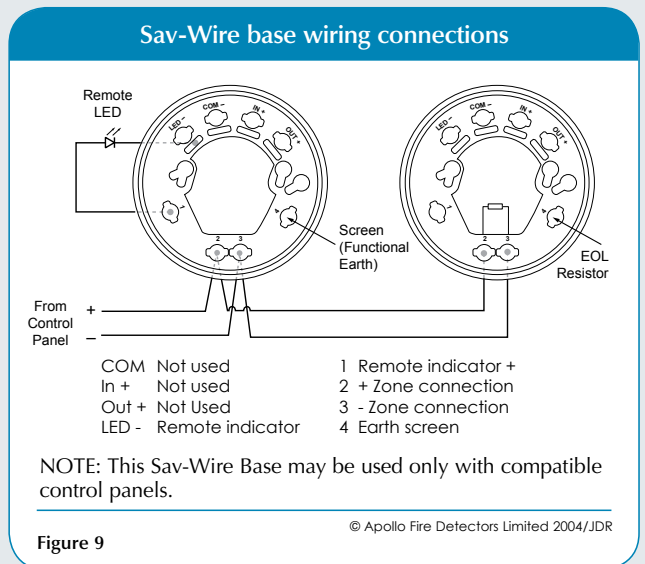

Figure 9

COMMISSIONING MADE EASY

Orbis has been designed with a number of features that make commissioning easier and that save time.

StartUp

When Orbis detectors are powered up they automatically enter a phase known as StartUp and in which they stay for 4 minutes. After this they revert to normal operation. If the detector is reset, ie, if power is disconnected for one second or longer, the detector will always enter StartUp for the first four minutes after power has been restored. The detector LED flashes red once a second to indicate that it is in StartUp.

What StartUp indicates

StartUp is used to check that the positive and negative cables are connected in the correct polarity and that power has been applied to the detector. If this is the case, the LED will flash red once a second.

StartUp will not check whether the IN+ and OUT+ connections have been transposed. This is not a problem if standard bases are used as the detector will operate normally.

If, however, diode bases are used and a detector is removed from a base with transposed positive connections none of the detectors beyond this point will operate.

FasTest®

Orbis detectors incorporate a test facility known as FasTest®.

In normal operation Orbis smoke detectors do not change to the alarm state at the first sensing of smoke. If they did, they could be too sensitive and cause false alarms. Algorithms determine the point at which the detector changes to alarm.

This could slow down routine maintenance during which detectors are tested by means of smoke or a smoke-simulating substance.

In order to avoid such a problem Orbis detectors have FasTest, a facility which is automatically available during StartUp and which modifies algorithms so that testing is possible within 4 seconds.

The problem of testing is even more acute in the case of heat detectors as they absorb a great deal of heat during testing. Orbis heat detectors also incorporate FasTest®.

In the case of heat detectors a fast test is defined as a sample which recognises a rise of 10°C within one minute. Since sampling takes place every 2 seconds an Orbis heat detector will respond within about 4 seconds.

Smoke or Heat Testing

Smoke or heat testing Orbis detectors is aided by the FasTest® feature. A detector will react rapidly to the correct stimulus if applied within 4 minutes after power up.

Choose the appropriate test function on the control panel and reset the detector circuit. This should place the detectors into FasTest®. Apply smoke or heat as appropriate and the detector should enter the alarm state within 4 seconds. The panel may sound the alarm and reset the zone automatically (refer to control panel's instructions). If not, silence the alarm and reset the panel. Repeat the procedure as necessary.

Note that the multisensor detector will respond to either smoke or heat while in FasTest®.

MAINTENANCE AND SERVICING

Detectors should be checked regularly at the intervals indicated by the locally applicable code of practice. Apollo recommends that detectors be checked at least once a year.

One of the features of Orbis is FasTest® which makes it possible to carry out a functional test, using smoke or heat, within about four seconds. If detectors appear not to be functioning correctly they should be returned to Apollo for testing.

If detectors are externally dirty they can be cleaned carefully with a damp cloth using a small amount of industrial alcohol.

DirtAlert™

Orbis detectors have drift compensation to compensate for changes caused by the environment. The most usual change is contamination.

If the detector is dirty to the point where it can no longer compensate, its LED will flash yellow while it is in StartUp. Maintenance checks should therefore include removing a detector from its base and re-inserting it or pressing reset on the panel to initiate StartUp.

A flashing yellow LED is not a sign that the detector needs to be replaced immediately. The decision to replace should be taken by the service engineer, taking the environment of the detector into account. If the detector is not replaced it will eventually cause false alarms.

When deciding how long to leave the detector on site in such a case, the following rule of thumb may be used:

installation time + 25%

For example, if a detector had been installed for four years when the LED flashed yellow, it could be left in place for up to 12 months.

Dirty detectors can be returned to Apollo for cleaning and recalibration.

APPROVALS AND REGULATORY COMPLIANCE

The Orbis range of detectors is approved by a large number of certification bodies. These include approvals to EN54:200 with LPCB, Vds, DIBT, BOSEC and FG. For further information on approvals held by Apollo contact the Sales Department or visit our website (details on page 2).

EU DIRECTIVES

Orbis complies with the requirements of a number of European New Approach Directives such as the EMC Directives 2004/108/EC and the Construction Products Directive 89/106/EEC. Visit the Apollo website to download EC certificates of conformity issued by the Notified Body, LPCB. Copies of Declarations of Conformity issued by Apollo for all applicable New Approach Directives are available on the Apollo website or from Apollo on request.

All Orbis products comply with the marking requirements of the WEEE Directive, 2002/96/EC. For further information on disposing of applicable electrical and electronic waste contact Apollo.

© Apollo Fire Detectors Ltd 2003 - 2010

A HALMA COMPANY



36 Brookside Road, Havant,
Hampshire, PO9 1JR, UK.

Tel: +44 (0)23 9249 2412
Fax: +44 (0)23 9249 2754



Email: sales@apollo-fire.co.uk
Web: www.apollo-fire.co.uk