

Wet Alarm Check Valve

Model: SSBJ-300

Wet Alarm Check Valve

Model: SSBJ-300

Flange/Groove/Flange*Groove/Groove*Flange

Technical Features

- Maximum Adjust Pressure: 200PSI-300PSI/PN10/PN16
- Flange Standard: ASME/ANSI B16.1 Class 125 or ASME/ANSI B16.42 CLASS 150 or BS EN1092-2 PN16 or GB/T9113.1
- Groove Standard: AWWA C606/ISO 6182-12
- Working Temperature: 4°C-70°C
- Installation Height of the Gong According to Clients' requirements
- Gong can be Installed indoor or outdoor through wall as to clients' requirements
- External Dimensions for reference only
- Coating details: Epoxy coated interior and exterior by Electrostatic Spray or Coating upon request
- Alarm check valves use in wet pipe of sprinkler system, Fire protection system



Valve Material List

Size	Name	Material	QTY.
1	Alarm Valve		1
2	Orifice,retard	C954/SS304	1
3	Tee	Steel/SS304	2
4	Nipple	Steel/SS304	6
5	Union	Steel/SS304	1
6	Nipple	Steel/SS304	1
7	Y Strainer	C954/SS304	1
8	Retard Chamber	Steel	1
9	Gong Assembly	Component	1
10	Nipple	Steel/SS304	1
11	Reducer Bushing	Steel/SS304	1
12	Pressure Switch	Component	1
13	Cross	Steel/SS304	1
14	Reducer Bushing	Steel/SS304	1
15	Plug	Steel/C954/SS304	1
16	Cross	Steel/SS304	2
17	Pressure Gauge	Component	3
18	3-way Valve Gauge	C954/SS304	3
19	Plug	Steel/C954/SS304	3
20	Orifice,retard	C954/SS304	1
21	Check Valve	C954/SS304	1
22	Nipple	Steel/SS304	1
23	Nipple	Steel/SS304	3
24	Tee	Steel/SS304	2
25	Nipple	Steel/SS304	4
26	Nipple	Steel/SS304	1
27	Nipple	Steel/SS304	1
28	Ball Valve	C954/SS304	1
29	Nipple	Steel/SS304	1
30	Ball Valve	C954/SS304	1
31	Elbow	Steel/SS304	2
32	Nipple	Steel/SS304	1
33	Ball Valve	C954/SS304	1

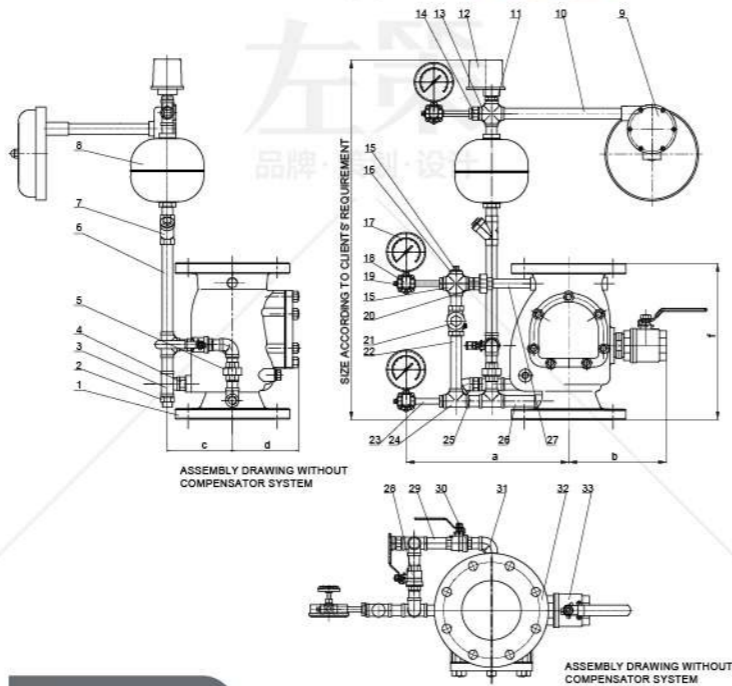

Dimensions

Size	a	b	c	d
2"	340	205	145	110
2.5"	340	205	145	110
3"	340	205	145	110
4"	342	250	160	136
5"	349	274	180	162
6"	349	274	180	162
8"	415	290	205	195
10"	475	340	240	235
12"	495	368	270	270

General Technical Information

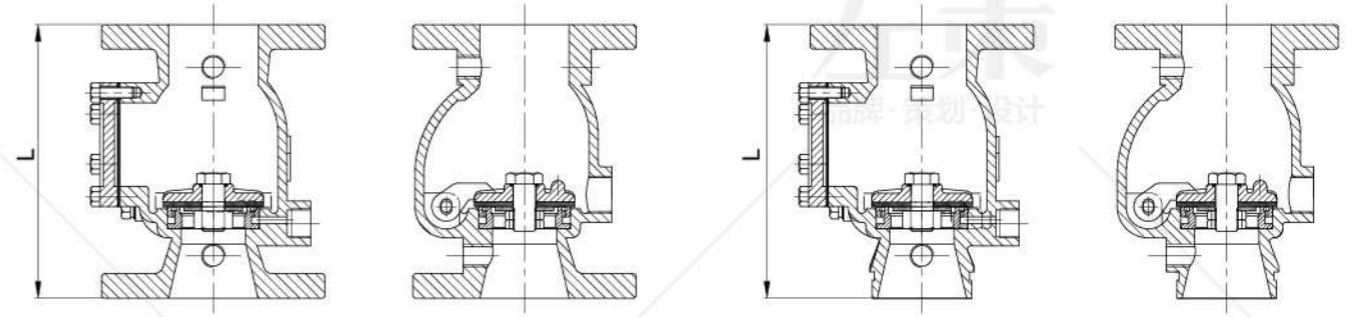

Flange*Flange



Dimension Chart

Size	L(mm)	L(inch)
DN50(2in)	233	9.17
DN65(2.5in)	236	9.29
DN80(3in)	245	9.65
DN100(4in)	316	12.44
DN125(5in)	386	15.20
DN150(6in)	390	15.35
DN200(8in)	438	17.24
DN250(10in)	535	21.06
DN300(12in)	622	24.49

Flange*Groove



Dimension Chart

Size	L(mm)	L(inch)
DN50(2in)	239	9.41
DN65(2.5in)	240	9.45
DN80(3in)	245	9.65
DN100(4in)	316	12.44
DN125(5in)	386	15.20
DN150(6in)	390	15.35
DN200(8in)	438	17.24
DN250(10in)	535	21.06
DN300(12in)	622	24.49

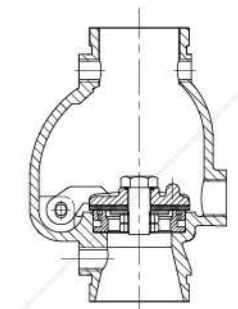
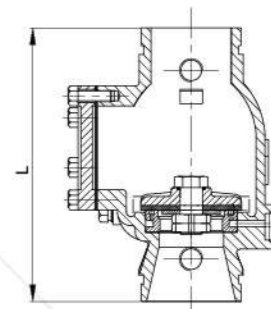
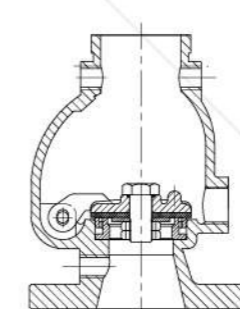
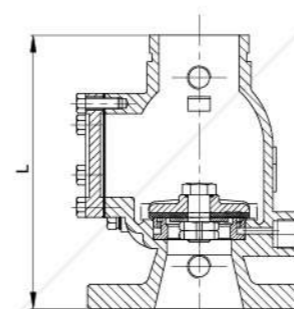

Groove*Flange

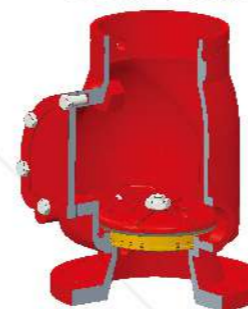

Dimension Chart

Size	L(mm)	L(inch)
DN50(2in)	239	9.41
DN65(2.5in)	240	9.45
DN80(3in)	245	9.65
DN100(4in)	316	12.44
DN125(5in)	386	15.20
DN150(6in)	390	15.35
DN200(8in)	438	17.24
DN250(10in)	535	21.06
DN300(12in)	622	24.49

Groove*Groove



Dimension Chart

Size	L(mm)	L(inch)
DN50(2in)	245	9.65
DN65(2.5in)	245	9.65
DN80(3in)	245	9.65
DN100(4in)	316	12.44
DN125(5in)	386	15.20
DN150(6in)	390	15.35
DN200(8in)	438	17.24
DN250(10in)	535	21.06
DN300(12in)	622	24.49