

Troubleshooting

Before investigating individual units for faults, it is important to check that the system wiring is fault free. Earth faults on data loops or interface zone wiring may cause communication errors.

Many fault conditions are the result of simple wiring errors. Check all connections to the unit. Do not overtighten screws when mounting the backbox as this will cause distortion of the moulding.

Fault Finding

Problem	Possible Cause
No response or missing	Incorrect address setting Incorrect loop wiring
Alarm condition	Glass or element incorrectly fitted or broken Test key not removed

Routine testing

Insert the test key into the hole at the bottom of the call point and push home. Observe routine test requirements as specified in EN54-11: 2001 or the applicable local code.

Resetting

After testing reset the call point by removing the test key and pushing up the front cover until it clicks home.

Transparent hinged cover

To provide additional protection against accidental operation, a transparent hinged cover with a locking tag, part no 26729-152 is available, which can be fitted to the manual call point included with this guide.

Please note that the call point does not conform to EN54-11 : 2001 when this lid is fitted and secured with the locking tag supplied.

For further information, please refer to the Discovery Engineering Product Guide, PP2052. For isolator operation information refer to PP2090. Both documents are available on request.



Discovery Manual Call Point (EN54) Installation Guide

General

The Discovery Manual Call Point (EN54) is available in two versions:

- part no. 58100-910, non-isolated red Manual Call Point with a standard backbox for surface wiring.
- part no. 58100-908, isolated red Manual Call Point with a standard backbox for surface wiring.

Installation

1. Fit the backbox (**Fig 1**) to the wall.
2. Run the cables from the loop into the backbox and connect them to the terminal blocks as shown in **Fig 2**. Ensure that functional earth/screen continuity is maintained. Screens should be connected to the yellow terminal block marked 1-4 on the black PCB cover.
3. If a loop continuity test is to be done, it should be carried out before securing the call point to the backbox (step 5). Insert the continuity links supplied with the backbox (**Fig 3**) into the terminal blocks before testing. After testing for continuity remove the connectors and store for re-use.
4. Set the unit address on the DIL switch in accordance with the address table overleaf.
5. Unlock the small front cover by inserting the forked key and pushing it home. Remove key, slide the cover down and remove the deformable element. Connect the terminal blocks as shown in **Fig. 2**, secure the call point to the backbox and refit the deformable element as required. Finally, replace the front cover in the reverse order in which it was removed and push it up until it locks.

The Discovery Manual Call Point (EN54) is a 'type A' call point and is suitable for indoor use only. For flush mounting, a suitable single-gang mounting box (minimum 20mm depth) is required. Discovery glasses are also available, part no. 26729-155 (pack of 5)

Wiring Details

All wiring terminals accept solid or stranded cables up to 2.5mm².

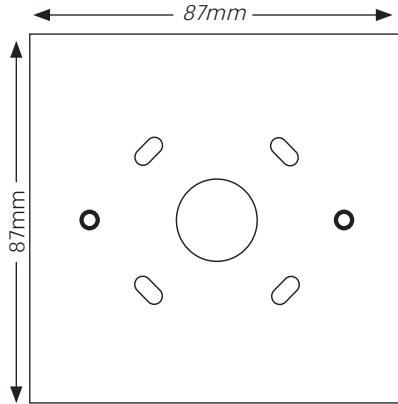

Fig 1 Backbox

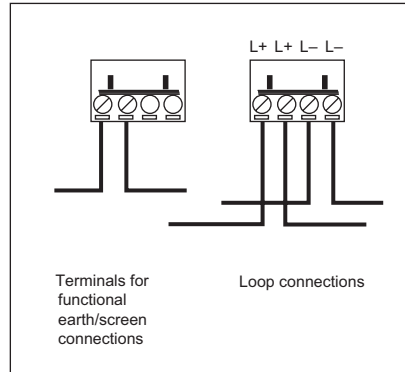

Fig 2 Terminal block connections

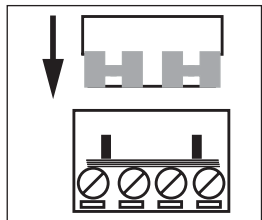

Fig 3 Continuity link

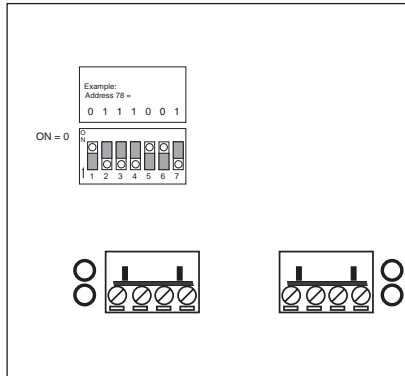

Fig 4 Terminal blocks fitted and address 78 set

Maximum Loop Current Consumption at 24V

typical switch-on surge, 2s typical
quiescent and alarm
LED illuminated

750µA
100µA
4mA

LED Indicator

- ☉ Illuminated red (under CIE control) when call point is operated
- ☉ Illuminated yellow when short-circuit isolator has operated (version with integrated isolator)

Address Setting

The address of the Manual Call Point is set using the DIL switch. All segments of the switch are set to 0 or 1, using a small screwdriver or similar tool.

A complete list of address settings is shown in the following table.

addr	DIL switch setting 1234567	addr	DIL switch setting 1234567	addr	DIL switch setting 1234567	addr	DIL switch setting 1234567	addr	DIL switch setting 1234567
1	1000000	11	1101000	21	1010100	31	1111100	41	1001010
2	0100000	12	0011000	22	0110100	32	0000010	42	0101010
3	1100000	13	1011000	23	1110100	33	1000010	43	1101010
4	0010000	14	0111000	24	0001100	34	0100010	44	0010100
5	1010000	15	1111000	25	1001100	35	1000010	45	1011010
6	0110000	16	0000100	26	0101100	36	0010010	46	0111010
7	1110000	17	1000100	27	1101100	37	1010010	47	1111010
8	0001000	18	0100100	28	0011100	38	0110010	48	0000110
9	1001000	19	1100100	29	1011100	39	1110010	49	1000110
10	0101000	20	0010100	30	0111100	40	0001010	50	0100110
51	1100110	61	1011110	71	1110001	81	1000101	91	1101101
52	0010110	62	0111110	72	0001001	82	0100101	92	0011101
53	1010110	63	1111110	73	1001001	83	1100101	93	1011101
54	0110110	64	0000001	74	0101001	84	0010101	94	0111101
55	1110110	65	1000001	75	1101001	85	1010101	95	1111101
56	0001110	66	0100001	76	0011001	86	0110101	96	0000011
57	1001110	67	1100001	77	1011001	87	1110101	97	1000011
58	0101110	68	0010001	78	0111001	88	0001101	98	0100011
59	1101110	69	1010001	79	1111001	89	1001101	99	1100011
60	0011110	70	0110001	80	0000101	90	0101101	100	0010011
101	1010011	106	0101011	111	1111011	116	0010111	121	1001111
102	0110011	107	1101011	112	0000111	117	1010111	122	0101111
103	1110011	108	0011011	113	1000111	118	0110111	123	1101111
104	0001011	109	1011011	114	0100111	119	1110111	124	0011111
105	1001011	110	0111011	115	1100111	120	0001111	125	1011111
								126	0111111

The switch in Fig 4 shows address setting 78 as an example of how to set the address

Commissioning

The installation must conform to BS5839-1: 2001 (or applicable local codes).

Ensure that a glass or deformable element is fitted to each call point before testing. Use the test key provided to check the operation of each device. A Discovery Test Set, part no. 55000-870, may be used to carry out functional testing of individual units. The test set can also perform data integrity tests of an entire system.

Note: the test key must remain inserted for at least 2 seconds to ensure the correct CIE response.