

Instruction Manual

VDOT-H2/VDOT-H2-H

Analog Heat Detector



ZETA ALARMS LIMITED
72-78 MORFA ROAD, SWANSEA, SA1 2EN
<http://www.velocitydetection.com>

Before Installation

Please read these instructions carefully and keep for future reference.

The information in this document is subject to change without notice. For updates please refer to our website.

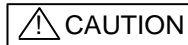

Do not use the products outside the rated power supply voltage range specified in the Specifications. It may cause a fire or damage to equipment.

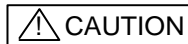

Do not disassemble, repair, or modify the products. It may cause a fire or electric shock.

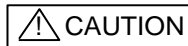

Make sure to turn the power off before commencing any wiring work. Otherwise it may cause electric shock or damage to equipment.

Note: Follow the requirements for the installation of the products in accordance with the Specifications. Otherwise it may cause malfunction.

Note: Do not install the product in any location where oil, dust, iron powder, chemicals, or hydrogen sulphide may occur or affect the product. It may cause damage to equipment.

Section 1 – INTRODUCTION

1.1 General description

The **V DOT-H2** and **V DOT-H2-H** is an attractively-styled, low profile, analog addressable, heat detector for use with the Velocity MMP Control Panel series in analog fire alarm systems.

This analog addressable heat detector has a specific detector address to provide exact detector locations throughout the installation. This allows for constant monitoring of the detector sensitivity and reports the detector's condition to the fire alarm control panel.

The **V DOT-H2** is a 8.3 °C (15 °F) rate-of-rise temperature heat detector with 57 °C (135 °F) fixed temperature alarm.

The **V DOT-H2-H** is a high temperature heat detector with 83 °C (181 °F) fixed temperature alarm.

1.2 LED Indicator

LED Indicators for 360° visibility (OMNIVIEW™ 360°) of VDOT-H2 and VDOT-H2-H operate as follows:

Green LED flashes in normal operation.

Red LED illuminates and Green LED flashes in an alarm condition.

1.3 VDOT-H2 and VDOT-H2-H common features

- * Low profile, stylish appearance
- * Soft addressing
- * Low monitoring current
- * Supplied with protective dust cover
- * OMNIVIEW™ 360 ° LED Indicator for polling and fire alarm indication

Section 2 – GENERAL OPERATION

The **VDOT-H2** heat detector initiates an alarm in response to both 8.3 °C (15 °F) rate-of-rise temperature or a 57 °C (135 °F) fixed temperature alarm point.

The **VDOT-H2-H** initiates an alarm in response to 83 °C (181 °F). Heat detector incorporates a highly linear thermistor circuit, with the thermistor mounted externally. The specially designed cover protects the thermistor while allowing maximum air flow. The thermistor circuit produces a voltage proportional to temperature which is scaled, and transmitted as a digitally encoded value to the control panel.

Section 3 – DIMENSIONS

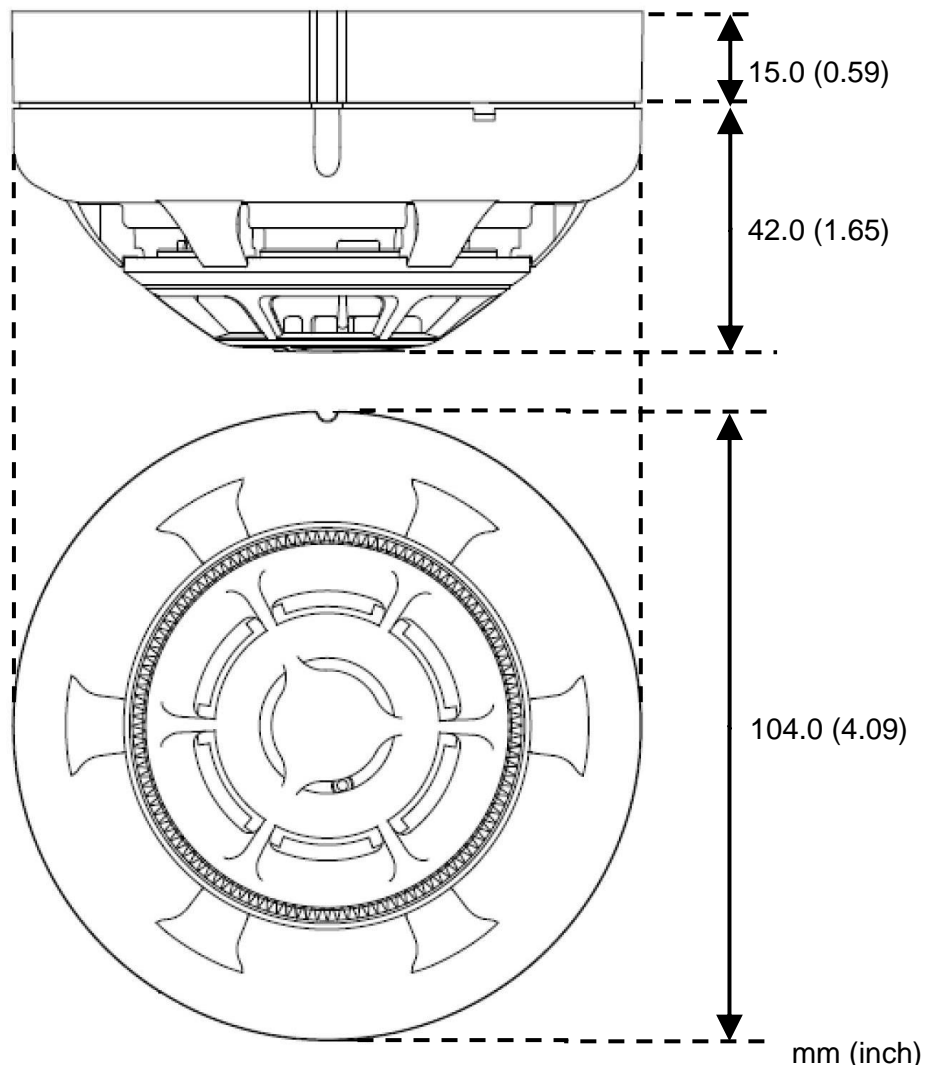

Figure 1: Dimension of VDOT-H2 and VDOT-H2-H

Section 4 – TERMINALS

The **VDOT-H2** and **VDOT-H2-H** heat detectors all have three terminal connections and the terminals are configured as follows:

Terminal	Description
1	SLC Positive
6	SLC Negative
3	To activate VDOT-STB-RL Relay Base

Note: Terminal 3 is used for the Relay Base VDOT-STB-RL.

Section 5 – DETECTOR MODELS

VDOT-H2 and **VDOT-H2-H** may be installed in the same signaling line circuit (SLC) as the detectors below:

Model	Description	Instruction Manuals
VDOT-PY	Analog addressable photoelectric smoke detector	GLT-299-7-1
VDOT-PYH	Analog addressable combination photoelectric smoke and heat detector 57 °C (135 °F) with 8.3 °C (15 °F) rate of rise	GLT-299-7-4
VDOT-DPH	Analog addressable combination photoelectric smoke (dual wave length) and heat detector 57 °C (135 °F) with 8.3 °C (15 °F) rate of rise	GLT-299-7-5

Section 6 – BASE MODELS

There are 5 mounting bases that are available for use with the **VDOT-H2**. For **VDOT-H2-H**, there are 2 mounting bases for use.

In order to operate correctly, it is important to use the appropriate mounting base as indicated in the table below. Refer to the specific mounting base instruction manuals for details.

Model	Description	Instruction manuals	Diameter	Number of Terminals	VDOT-H2	VDOT-H2-H
VDOT-UB4	Standard mounting base	GLT-299-7-6	4 inch	4	X	X
VDOT-UB4-6*	Larger mounting base	GLT-299-7-7	6 inch	4	X	X
VDOT-S6 Base	Sounder mounting base	GLT-299-7-10	6 inch	5	X	-
VDOT-STB-RL	Relay mounting base	GLT-299-7-9	4 inch	6	X	-
VDOT-STB-SCI	Short circuit isolator base	GLT-299-7-8	4 inch	4	X	-
VDOT-ADP**	Adapter mounting plate	GLT-299-7-11	6 inch	-	X	-

* The Model VDOT-UB4-6 mounting base is intended for applications where a 4 inch square or octagonal electrical junction box is required.

** The VDOT-ADP Adapter Mounting Plate is intended for the VDOT-STB-RL Relay Mounting Base and VDOT-STB-SCI Short Circuit Isolator Base for applications where a 4 inch square or octagonal electrical junction box is required.

Section 7 – ADDRESS SETTING

The **VDOT-H2** and **VDOT-H2-H** require compatible addressable communications to the control panel in order to function properly. All detectors have random addresses from the factory before installation. The VDOT-AD2 Address Programmer is used for setting the address between 1 and 254 decimal of all devices prior to installation. See Annex A for the handling. Once addressed, connect these detectors to UL listed Control Panel series.

Section 8 - INSTALLATION

8.1 Before installing

These heat detectors must be installed in compliance with the manuals of the Control Panel series.

The installation must meet the requirements of the Authority Having Jurisdiction (AHJ).

The detectors offer maximum performance when installed in compliance with the National Fire Protection Association (NFPA); see NFPA 72.

Note: ZETA ALARMS LIMITED is not responsible for the product which is improperly installed, maintained and tested.

8.1.1 Location requirement

When installing the detector please consider the following items. Otherwise the detector might not provide optimum performance.

- Indoor use only.
Place the detector away from a ventilation fan or the air outlet of air conditioner, at least 1.5 m (5 ft).
- On the ceiling, place the detector at least 10 cm (4 in.) from the wall.

The detector should not be installed in places such as:

- Place with plenty of air flow (close to a ventilation fan, air conditioner, or place with drafts)
- Place close to heating appliance

8.2 Heat Detector Applications



These detectors are intended for use with photoelectric smoke detectors. A heat detector by itself does not provide life safety protection.

Heat detectors sense change in air temperature and initiate an alarm condition based on a fixed-temperature point, rate of temperature rise, or amount of temperature rise above ambient condition. Spot type heat detectors should be selected so that the rating is at least 11 °C (20 °F) above maximum expected ceiling temperature. Ceiling height, construction, and ventilation play significant roles in detector performance and must be considered when determining detector placement. The operating temperature range is 0 °C to 37.8 °C (32 °F to 100 °F) for VDOT-H2 and 0 °C to 65.6 °C (32 °F to 150 °F) for VDOT-H2-H.

8.2.1 Spacing of Heat Detectors

Spot type heat detector spacing is based on detector installation on a flat smooth ceiling at 3 m (10 ft.) high. Spacing of spot type detector is shown in Figure 2. The coverage area of a detector is represented as a square. Actual detector coverage covers a circle whose radius is 0.7 times the listed spacing. Since all of the area within the detector's circle of coverage is suitable for detecting a fire, the shape and dimensions of the detector coverage "square" in Figure 3 may be modified. Coverage area should remain within the overall detector circle of coverage as shown in Figure 4.

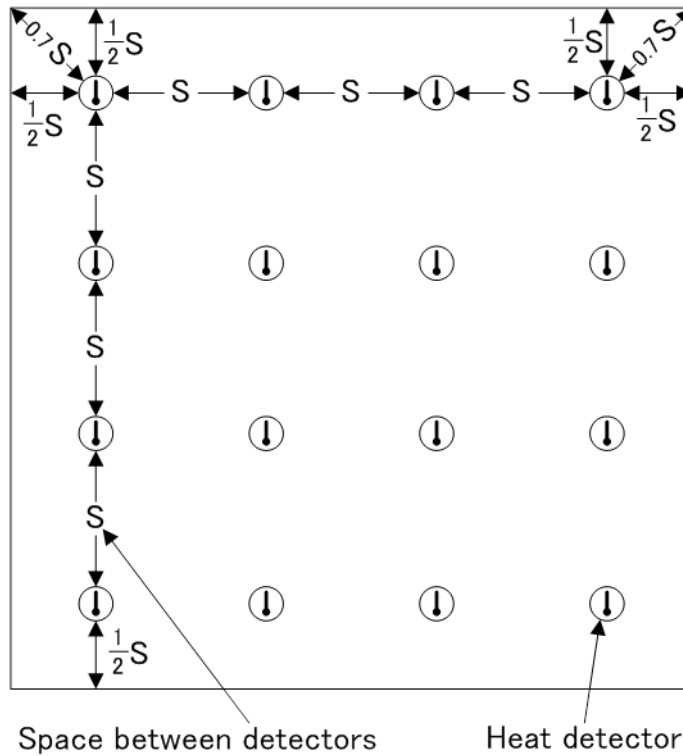

(1) Heat detector; S = Listed spacing between detectors

Figure 2: Listed heat detector spacing

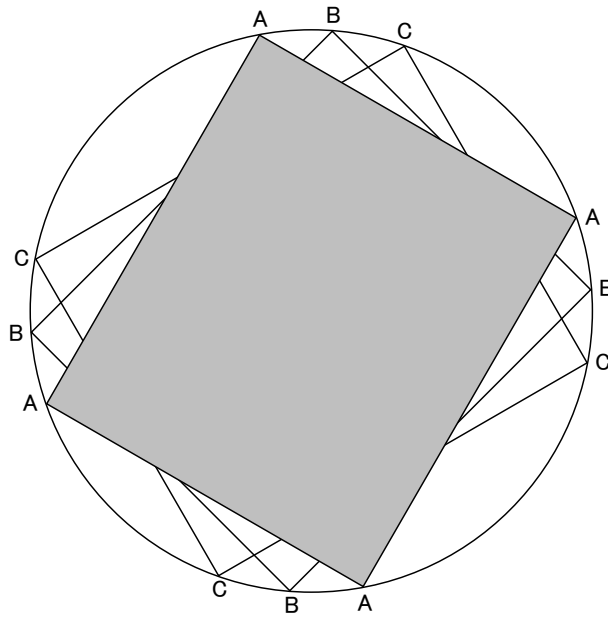

Figure 3: Detector circle of coverage

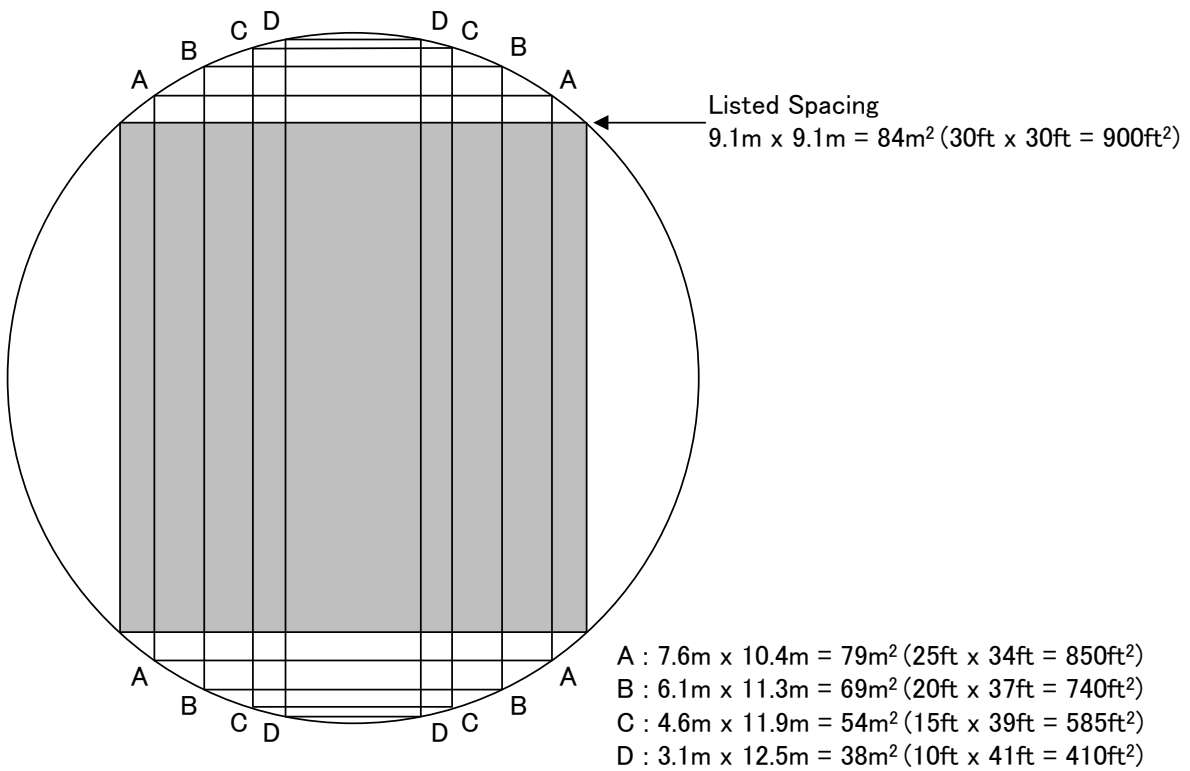

Figure 4: Alternative heat detector coverage configurations

When installed on the ceiling, spot type heat detectors must be located a minimum of 10 cm (4 in.) from side walls. When installed on side walls, the detector must be between 10 cm (4 in.) and 30 cm (12 in.) from the ceiling, as shown in Figure 5.

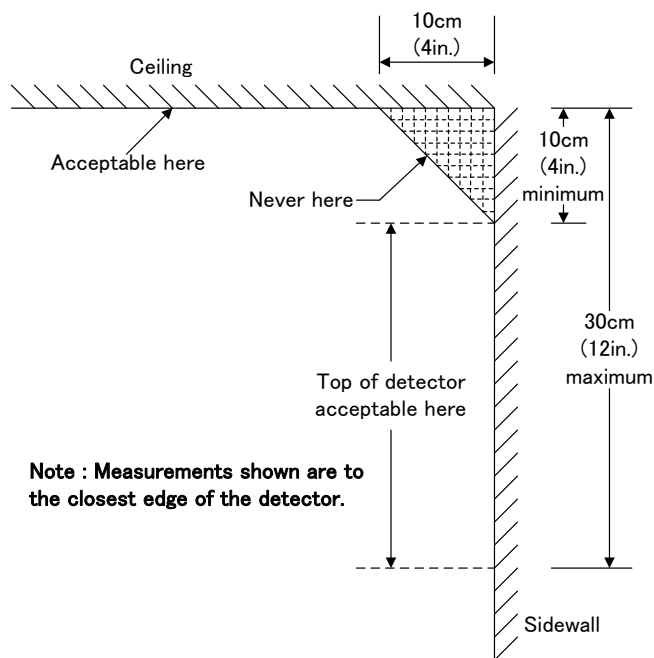

Figure 5: Detector placement near ceiling or wall joints

The following figure shows the required heat detector spacing for a 60.9 m (200 ft.) by 60.9 m (200 ft.) room with a 3m (10 ft.) ceiling. Figure 6 shows 16 heat detectors with the required spacing of $S = 15.3$ m (50 ft.).

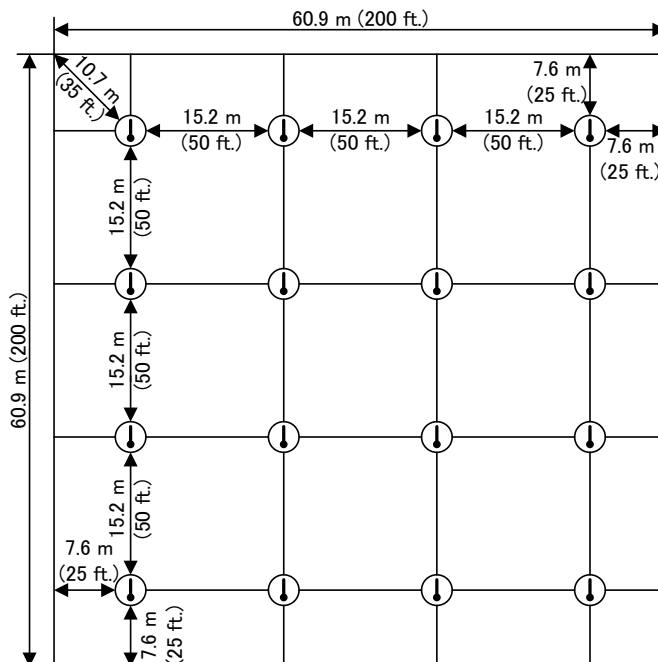

Figure 6: Heat detectors spacing example

8.2.2 Ceiling construction and heat detectors

When installing heat detectors on other than flat and smooth ceilings or at ceiling height greater than 3 m (10 ft.), spacing must be adjusted. The table below shows the reduction in listed spacing to be applied when detectors are mounted on ceilings higher than 3 m (10 ft.). This reduced spacing allows the detectors to have the equivalent response of detectors located on a 3 m (10 ft.) ceiling.

Ceiling height	Percent of listed spacing
0 to 3 m (0 to 10 ft.)	100
3 to 3.7 m (10 to 12 ft.)	91
3.7 to 4.3 m (12 to 14 ft.)	84
4.3 to 4.9 m (14 to 16 ft.)	77
4.9 to 5.5 m (16 to 18 ft.)	71
5.5 to 6.0 m (18 to 20 ft.)	64
6.0 to 6.7 m (20 to 22 ft.)	58
6.7 to 7.3 m (22 to 24 ft.)	52
7.3 to 7.9 m (24 to 26 ft.)	46
7.9 to 8.5 m (26 to 28 ft.)	40
8.5 to 9.1 m (28 to 30 ft.)	34

Spot type detector ceiling height reduction percentages

8.2.3 Exposed solid joists

Exposed solid ceiling joists may impede the heat flow to the detectors. A joist is defined as a solid member projecting down from the ceiling surface for a distance of more than 10 cm (4 in.) and spaced at intervals of 91 cm (36 in.) or less, center to center. The spacing of heat detectors must be reduced by 50% in the direction perpendicular to the joist. The detectors shall be mounted on the bottom of the joists.

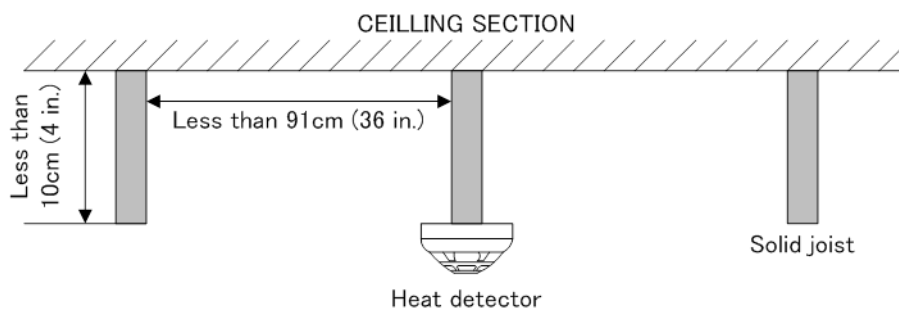

Figure 7: Heat detector spacing — solid joist construction (side view)

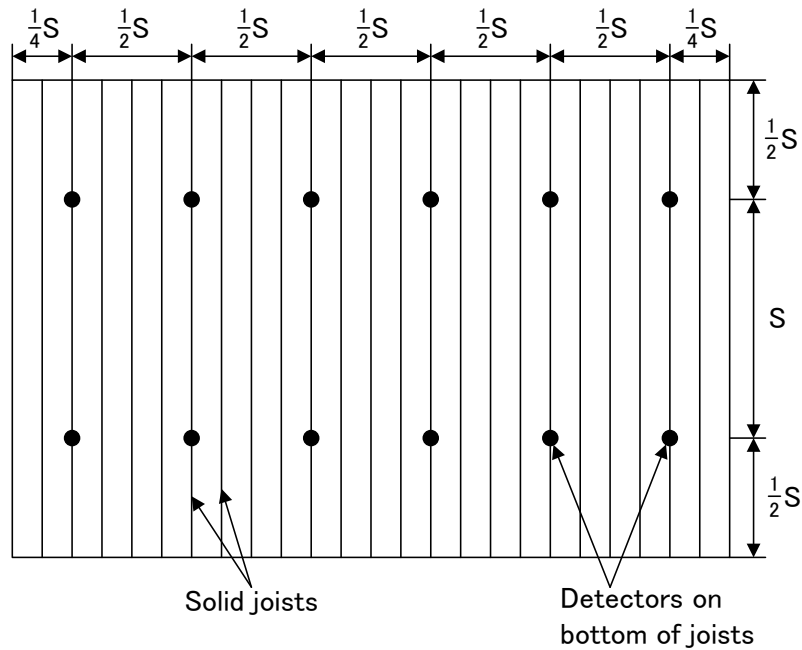

Figure 8: Heat detector spacing — solid joist construction (plan view)

8.2.4 Exposed beams

Exposed beams may impede the heat flow to the detectors. Beams are defined as members extending 10 cm (4 in.) or more down from the ceiling and spaced more than 91 cm (36 in.) apart. The spacing of heat detectors must be reduced by 33% in the direction perpendicular to the beam. Detectors can be mounted on the bottom of the beams which are less than 30.4 cm (12 in.) in depth and less than 2.4 m (8 ft.) on center. If beams are greater than 46 cm (18 in.) in depth and are spaced more than 2.4m (8 ft.) on center, then each bay formed by the beams must have at least one detector mounted on the ceiling. If the ratio of beam depth (D) to ceiling height (H), D/H, is greater than 0.1 and the ratio of beam spacing (W) to ceiling height (H), W/H, is greater than 0.4, heat detectors should be located in each beam. If either the ratio of beam depth (D) to ceiling height (H), D/H, is less than 0.1 or the ratio of beam spacing (W) to ceiling height (H), W/H, is less than 0.4, heat detectors should be located on the bottom of the beams.

Calculation:

$D/H > 0.1$ AND $W/H > 0.4$: Mount the detector on the ceiling

$D/H < 0.1$ OR $W/H < 0.4$: Mount the detector on the bottom of the beam

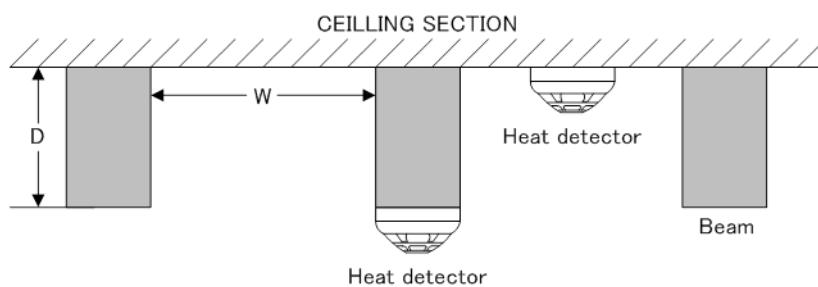
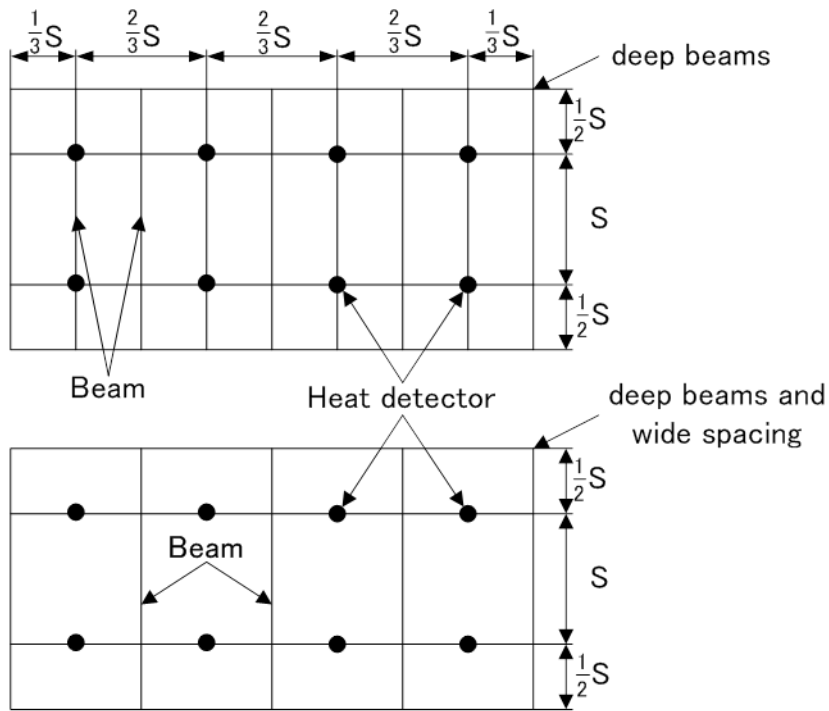

Figure 9: Heat detector spacing — beam construction (side view)



$S = 50 \text{ ft. (15 m)}$ $\frac{2}{3} S = 33 \text{ ft. (10 m)}$ $\frac{1}{2} S = 25 \text{ ft. (8 m)}$ $\frac{1}{3} S = 17 \text{ ft. (5 m)}$

Figure 10: Heat detector spacing — beam construction (plan view)

- Notes:**
- Detectors can be installed on the bottom of beams when the beams are less than 30 cm (12 in.) deep and beam spacing is less than 2.4 m (8 ft.).
 - Beams less than 20 cm (8 in.) deep are considered flat ceilings. Heat detectors must be installed on the bottom of the beams.
 - Spacing of beams deeper than 20 cm (8 in.) must be reduced by 1/3 of the listed spacing.

8.2.5 Sloping ceiling (peaked and shed)

In the rooms with peaked ceilings, the first row of detectors must be located within 1 m (3 ft.) (measured horizontally) of the ceiling peak, but not closer than 10 cm (4 in.) vertically to the peak. Additional detectors, if required, must be located based on the horizontal projection of the ceiling and the type of ceiling construction. In the rooms with shed ceilings having a slope greater than 1 m in 8 m (1 ft. in 8 ft.), the first row of detectors must be located within 1 m (3 ft.) of the high end of the ceiling. Additional detectors, if required, must be located based on the horizontal projection of the ceiling and the type of ceiling construction. For a ceiling slope of less than 30 degrees, all detectors must be spaced using the height at the peak. For a ceiling slope of 30 degrees or greater, all detectors must be spaced using the average slope height or the height of the peak.

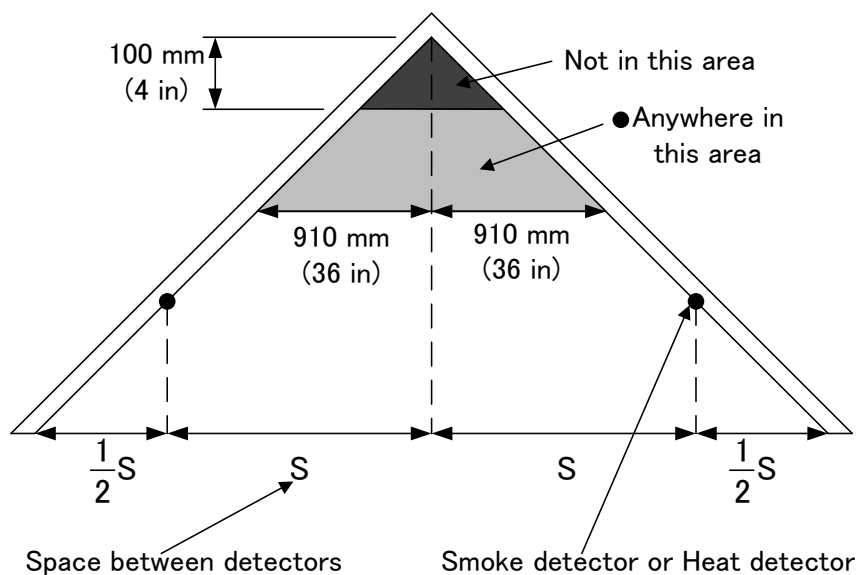

Figure 11: Heat detector spacing — Sloped ceiling (peaked type)

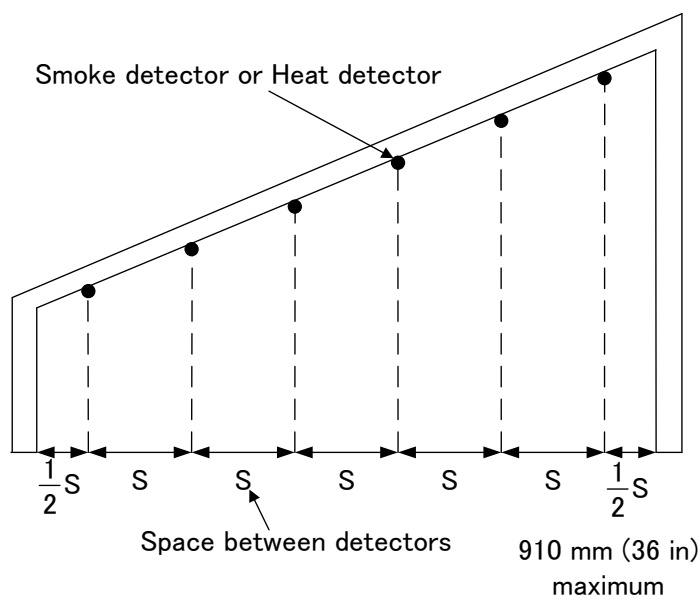

Figure 12: Heat detector spacing — Sloped ceiling (shed type)

8.3 Procedure for installing

Note: All wiring must be installed in compliance with the National Electrical Code, applicable local codes and the Authority Having Jurisdiction.

Proper wire gauges should be used. The installation wires should be color coded to limit wiring mistakes and ease system troubleshooting. Improper connections will prevent a system from responding properly in the event of a fire.

Remove power from the communication line before installing heat detectors.

1. Pass the field wiring through the rear center cable opening in the mounting base. Install the base to the electrical box with screws via the base mounting holes. Connect the field wiring to the base terminals, as detailed in Figure 13. Do not use looped wire under terminals (See Figure 14).
2. Using the VDOT-AD2 Address Programmer, set the desired address for each heat detector. See Annex A for the handling.
3. Install the heat detector into the mounting base, making sure the wiring does not obstruct mounting of the detector head. Push the heat detector into the mounting base while turning it clockwise until the heat detector locks into place. Use a small hexagonal wrench to set the tamper resist feature (if required), see Figure 15.
4. After the heat detector has been installed, snap on the supplied plastic dust cover onto the detector to keep out dust during construction.
5. Apply power to the control panel to configure the detectors to the fire alarm control panel.
6. Test the heat detector(s) as described in the TESTING section of this manual.

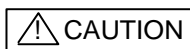

After commissioning has been completed remove and discard the dust cover.

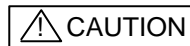

Smoke and heat detectors are not to be used with detector guards unless the combination has been evaluated and found suitable for that purpose.

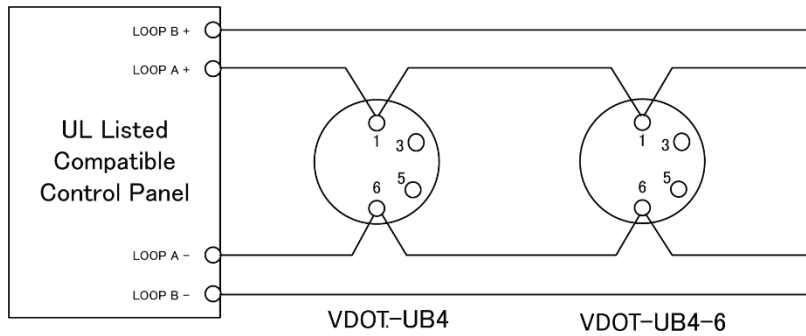

Figure 13: Wiring diagram for VDOT-UB4 and VDOT-UB4-6

SLC Line impedance is 50Ω at maximum and the maximum length is 2km.

Refer to the manual of control panel series to determine correct maximum loop load and maximum loop resistance for devices connected to each loop.

CAUTION

Use cable AWG12-20 for wiring. Do not connect different gauge cables at one terminal in order to prevent loosening.

CAUTION

Do not connect cables in reverse polarity. Failure to connect the polarity correctly could result in damage to other equipment.

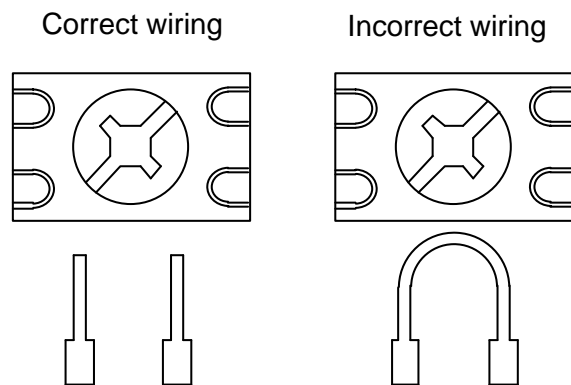

Figure 14: Correct and incorrect wiring method

CAUTION

For system monitoring — For terminals 1 and 6 do not use looped wire under terminals. Break wire run to provide monitoring of connections.

8.4 Tamper resistance feature

The VDOT-UB series, VDOT-S6 Base, and VDOT-STB series of smoke/heat detector mounting bases have a tamper-resist feature that works in conjunction with the heat detectors. When this feature is enabled, the heat detectors cannot be removed from the base without the use of a small hexagonal wrench. To avoid unauthorized removal of the heat detector, turn the locking screw in the mounting base counterclockwise until the screw extends out about 4 mm (3/16 in.) from the rim of the base, as shown in the Figure 15.

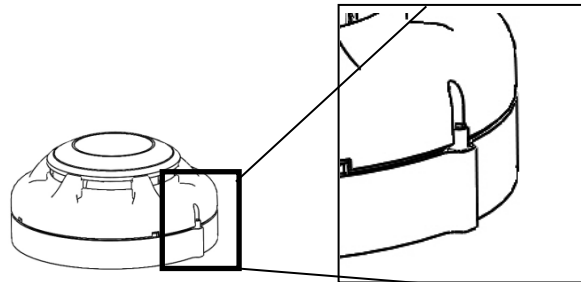

Figure 15: Position of the locking screw to lock the detector

Note: If the detector is installed on a high ceiling where a tool (ladder, etc.) is needed, it is not recommended to use the locking screw.

Section 9 – TESTING

- Notes:**
- Before testing, notify the proper authorities that the system is undergoing maintenance, and will temporarily be out of service.
 - Disable the system to prevent unwanted alarms.
 - All sensors must be tested after installation and periodically thereafter.
 - Testing methods must satisfy the Authority Having Jurisdiction (AHJ).
 - When carrying out site testing of the detector, the control panel must be set to “One Man Walk Test” mode prior to the test.

Sensors offer maximum performance when tested and maintained in compliance with NFPA 72. The sensor may be tested in the following ways:

- A. Direct Heat Method (Hair dryer of 1000 – 1500 watts)
1. From the side of the detector, direct the heat toward the sensor. Hold the heat source about 15 cm (6 in.) away to prevent damage to the cover during testing.
 2. The red LEDs on the detector should light when the temperature at the heat detector reaches the alarm set point. If the red LED indicator fails to light, check the power to the detector and the wiring in the detector base.
 3. After the detector has given the alarm condition, the detector automatically is reset by the control panel. The detector can also be reset at the control panel manually. Detectors that fail these tests should be cleaned as described under MAINTENANCE Section and retested. If the detectors still fail these tests they should be returned for repair.

B. Direct Heat Method (Heat Calibur HO-HC11 Heat Detector Tester)

Please refer to the instruction manual of HeatCalibur HO-HC11 for details.

1. Turn Master Power switch on and press the Power button on the panel of the Tester. The LCD Display and LED's should light.
2. Select Test Type by pressing the Test Type ↓ button, the LED will light to display selected test type:
 - a. ROR - Rate of Rise Temperature Test
 - b. FIXED - Fixed Temperature Test
3. Select Test Mode by pressing the Test Mode ↓ button, the LED will light to display selected test mode:
 - a. STD - Standard Test Mode
 - b. MULTI - Multiple Test Mode
4. Select Temperature Range by pressing the Temp Range ↓ button, the LED will light to display selected Temperature Range:
 - a. HIGH - High Temperature Range (87.8°C-98.9°C)(190°F-210°F) - VDOT-H2-H
 - b. LOW - Low Temperature Range (37.8°C-57.2°C)(100°F-135°F) - VDOT-H2
5. Press and hold Start Test button for 2 seconds until "Ready" is displayed on the LCD.
6. Place the Heat Detector Tester over the detector to be tested to start the test, press the outer ring against the ceiling to start test.
 - a. When the test has started a beep will sound, and the test will continue as long as the outer ring makes contact with the ceiling.
 - b. Hold the Heat Detector Tester over the detector until the detector alarms.
7. Remove the Heat Detector Tester from the detector to stop testing. The Heat Detector Tester will beep twice when test is stopped, the fan will continue to run for 15 seconds to cool the unit.

If the unit is not removed before set test length (60-90 seconds),the unit beeps twice and the display flashes between "Error", and "Timeout" to reflect that test stopped before the detector alarmed.
8. When testing is complete, turn the Master Power switch off.
9. The red LEDs on the detector should light with the green LED flashing when the temperature at the heat detector reaches the alarm set point. If the LEDs fail to light, check the power to the detector and the wiring in the detector base.
10. After the detector has given the alarm condition, the detector automatically is reset by the control panel. The detector can also be reset at the control panel manually. Detectors that fail these tests should be cleaned as described under MAINTENANCE Section and retested. If the detectors still fail these tests they should be returned for repair.

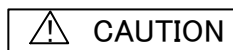

Do not use heat guns used for paint stripping or soldering pipes, as these heat guns generate sufficient heat to damage the detector, and should not be used for testing heat detectors.

Section 10 - MAINTENANCE

- Notes:**
- Before cleaning, notify the proper authorities that the system is undergoing maintenance, and therefore the system will temporarily be out of service.
 - Disable the loop or system undergoing maintenance to prevent unwanted alarms.

It is recommended that the sensor be removed from its mounting base for easier cleaning and that sensors be cleaned at least once a year.

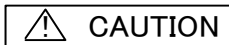

Do not disassemble, repair, or modify the products. It may cause a fire or electric shock.

1. Carefully remove the detector head from its base.
2. Use a soft, lint-free cloth, moistened with alcohol for sticky deposits, to clean the plastic enclosure.
3. Using a soft bristle brush (e.g. an artist's paint-brush) carefully brush around the thermistor, avoiding touching the thermistor.
4. Ensure that no debris is left on or around the thermistor once cleaning is complete.
If the unit needs further cleaning, or is damaged please return the complete detector to ZETA ALARMS LIMITED for warranty service.
5. Reinstall the detector.
6. Test the detector according to Section 9 - TESTING.
7. Set the system back to normal operation mode.
8. Notify the proper authorities that the system is back on line.

Section 11 – SPECIFICATIONS

Sensing Element	Thermistor (Negative temperature coefficient)
LED Visual Indicator	Stand-by: Flashing green LED
	Alarm: Solid red LED with flashing green
Operating Voltage Range	20 VDC to 38 VDC Peak
System Voltage	35 VDC
Stand-by Current	200 μ A
Alarm Current (with red LED)	5 mA
Fixed Alarm Temperature (Model - VDOT-H2)	57 °C (135 °F)
Rate of Rise Detection	Responds to greater than 8.3°C (15 °F)/min.
Fixed Alarm Temperature (Model - VDOT-H2-H)	83 °C (181.4 °F)
UL Ambient Installation Temperature	0 °C to +37.8 °C (32 °F to 100 °F) Model - VDOT-H2
	0 °C to +65.6 °C (32 °F to 150 °F) Model -VDOT-H2-H
Operating Temperature	-10 °C to +55 °C (14 °F to 131 °F) Model - VDOT-H2
	-10 °C to +65.6 °C (14 °F to 150 °F) Model -VDOT-H2-H
Storage Temperature	-20 °C to +60 °C (-4 °F to 140 °F)
Charging Time	1 minute
Relative Humidity	\leq RH95% non-condensing
Addressing Method	Soft addressing, Non-Volatile EEPROM
Address	1-254 (decimal)
Maximum Quantity per Loop	254 units (See Note 1)
Material	R2200 (Idemitsu Kosan Co.,Ltd)
Dimensions	Φ 104mm D x 42mm H (Φ 4.1" x 1.65" H) (Detector head)
	Φ 104mm x 15mm H (Φ 4.1" x 0.59" H) (with VDOT-UB4 base)
Weight	100g (Detector head only)
	165g (Detector head with VDOT-UB4 base)
Standard	UL521

Note 1: Please refer to the Control Panel detailed procedures for complete instruction on additional technical details pertaining to this connection.

FOR WARRANTY SERVICE, RETURN TO:
ZETA ALARMS LIMITED
72-78 MORFA ROAD, SWANSEA, SA1 2EN
<http://www.zetaalarmsystems.com>

Section 12 – WARRANTIES

- 12.1. Zeta warrants to the customers that:
- (a) all products supplied hereunder will be of merchantable quality and will comply with any specification agreed between Zeta and customer.
 - (b) it is not aware of any rights of any third party in the market which would or might render the sale of the products, or the use of any of the trade marks on or in products, or the use of any of the trade marks on or in relation to the products, unlawful.
- 12.2. In the event of any breach of the Zeta's warranty in Clause 12.1(a) whether by reason of defective materials, production faults or otherwise, Zeta's liability shall be limited to:
- (a) replacement of the products in question; or
 - (b) at the Zeta's option, repayment of the price where this had been paid.
- And the warranty period is three (3) years from the shipment from Zeta's factory.
- 12.3. Notwithstanding anything to the contrary in this warranty terms, Zeta shall not be liable to the customer by reason of any representation or implied warranty, condition or other term or any duty at common law, or under the express terms of this warranty terms, for any consequential loss or damage whether for loss of profit or otherwise and whether occasioned by the negligence of Zeta or its employees or agents or otherwise, arising out of or in connection with any act or omission of Zeta relating to Velocity or supply of the products, their use by any customer.
- 12.4. Customer shall indemnify Zeta against all loss, damages, liabilities, costs and expenses which Zeta may suffer or incur as a result of or in connection with any breach by customer of this warranties terms or any laws or regulations of any jurisdiction or any rules of any governing authorities.

Annex A

Quick Instruction of VDOT-AD2

This quick instruction of VDOT-AD2 is prepared to VDOT-H2 and VDOT-H2-H. Please refer to “VDOT-AD2 programmer instruction manual (GLT-299-7-19 Rev.0)” for details.

Preparation

1. VDOT-AD2 requires two 9v PP3 batteries.
 - a) Before inserting the batteries, confirm the VDOT-AD2 is switched off and check polarity of battery, or damage could result.

Indicate current address

1. Turn the power switch ON.
 - a) For one second, all LED's are lit and the buzzer sounds.
2. Push the detector into the base on the VDOT-AD2 while turning it clockwise until the detector locks into place.

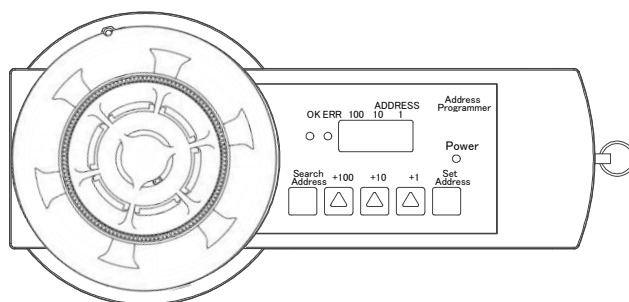

Figure A.1: Mounting a detector on VDOT-AD2

3. Press the [Search] Key
 - a) Buzzer sounds, then the VDOT-AD2 starts transmitting to the detector.
 - b) Do not remove the detector when transmitting, or damage could result.
4. The 7 segment LED reads [Customer code], [Type of device], [Address] in turn.
 - a) The buzzer sounds, ERROR LED lights and the 7 segment LED display's an ERROR CODE when an unsupported or defective device is connected.

0.1 1 → 1 2.3 → 0 0 3.

↑ ↑ ↑
Customer code Type of device Address

【Note - Dot position】

The 7 segment LED is distinguishes the Customer Code, Type and Address by the dot position in the LED.

The information displayed by the 7 segment LED cycles every second and stops whilst displaying the [address] at the end of the second cycle.

Type of device is assigned to the detectors as below.

VDOT-H2: 133

VDOT-H2-H: 134

Pressing any key at any time during the information collection cycle, forces the VDOT-AD2 to display the address, and await new address selection.

Set new address

1. +100, +10, +1 keys are used to select the new address.
2. Press the [Set] key
 - a) The buzzer sounds, and all LED's are turned off. The VDOT-AD2 then starts transmitting to the detector.
 - b) Do not remove the detector.
3. The 7 segment LED shows the new address and "complete" LED lights. If an unsupported or defective device is connected the buzzer sounds, ERROR LED is lit and the 7 segment LED reads ERROR CODE.
4. To continue changing the address for another device, change the detector and then repeat from paragraph 3.

To finish changing addresses, turn the POWER SW off.