



LIFE SAFETY & INCIDENT MANAGEMENT

Submittal Guide

# iO Series

Intelligent fire alarm solutions up to 1,000 points



See what's possible now.





LIFE SAFETY & INCIDENT MANAGEMENT

Project: \_\_\_\_\_

Contact: \_\_\_\_\_

Date: \_\_\_\_\_

Thank you for giving us the opportunity to provide this submittal for an iO Series Life Safety System. iO Series combines analog addressable detection with technologically advanced sensor diagnostic capabilities. Together these innovations offer unsurpassed stability, reliability, and flexibility.

This guide provides a summary of these innovations and includes a comprehensive presentation of related system components and devices. Products we are submitting for your consideration are indicated by a checkmark in the margins of the pages that follow.

More detailed information can be found in individual data sheets dedicated to each product. All these sheets, along with guide specifications and other useful product information, are available electronically at [www.edwardsfiresafety.com](http://www.edwardsfiresafety.com).

Thank you for giving us the opportunity to provide this submittal. Please do not hesitate to contact us should you require further information.

\_\_\_\_\_

iO Series  
Intelligent Control

Initiating  
Devices

Notification  
Appliances

Hazardous Location  
Devices

Door Holders  
& Relays



Submittal Guide

# iO Series

Intelligent fire alarm solutions  
up to 1,000 addressable points



### ***iO Series Submittal Guide***

Intelligent fire alarm solutions for small buildings

© 2019 United Technologies Corporation. All rights reserved.  
EDWARDS is a registered mark in the United States and other countries.

8985 Town Center Pkwy, Bradenton, FL 34202

E85005-0132

Wiring diagrams provided herein are for information and reference only and are not to be used for installation purposes. Consult the appropriate installation documents for wiring and configuration details.

This guidebook is for information only and is not intended as a substitute for verbatim legislated requirements. For authoritative specifications regarding the application of life safety, security, and access control systems, consult current editions of applicable codes and standards. For authoritative interpretation of those codes and standards, consult your local authority having jurisdiction.

While every effort has been made to ensure the accuracy and completeness of this guidebook, the authors and publishers assume no responsibility for errors, inaccuracies, omissions, or any inconsistencies herein.

*EST, Genesis Series, and Signature Series* are trademarks of UTC.



# Cohesive, comprehensive analog addressable fire alarm for small buildings.

With control panels, devices, and accessories all engineered to work in unison, iO Series systems provide reliable performance and the advanced features you need for successful installation and worry-free operation. Best of all, iO Series leaves you in control – not hemmed in by a limited product line. Our extensive range of fire alarm products gives you the freedom to tailor each system to the particular needs of the building – and the budget of the building owner – while a robust feature set leaves plenty of room for upgrades, expansions, and retrofits long into the future.

But innovative features tell only part of the story: when you specify iO Series you're getting more than outstanding value in a fire alarm panel; you're benefitting from a whole family of control, detection, and notification appliances finely tuned to work together – engineered and tested to function as a single unified system.

Built on the successes of the past, and meeting the needs of the future, iO Series is the changing face of small building fire detection today.

<b>iO Series Analog</b>	<b>1</b>
System Specifications .....	2
Control Panels.....	3
Option Cards.....	4
Power Supplies .....	6
Remote annunciation .....	8
Accessories.....	10
<b>Intelligent Analog Initiating Devices</b>	<b>11</b>
Combination CO/Fire Detectors.....	12
Fire Detectors.....	13
Duct Smoke Detectors .....	13
Detector Bases .....	14
Detector Accessories .....	15
Input/Output Modules .....	16
Pull Stations .....	22
<b>Notification Appliances</b>	<b>23</b>
LED Compact Strobes, Horns & Horn-Strobes.....	25
Low Frequency Horns and Horn-Strobes .....	28
Outdoor Horns & Strobes .....	29
Wall Speakers & Speaker-Strobes .....	30
Ceiling Speakers, Horns & Strobes.....	31
Outdoor Speakers & Strobes.....	32
Audible Signals.....	33
Harsh Environment Signals.....	34
Accessories.....	35
Audio Notification System.....	36
<b>Hazardous Location Devices</b>	<b>37</b>
Initiating Devices.....	38
Notification Appliances .....	39
<b>Door Holders &amp; Relays</b>	<b>40</b>
Door Holders.....	40
Relays .....	40
SPDT Relays .....	41



See what's  
possible now.



*Detection & Alarm Since 1872.*

---

Mass Notification • Smoke Detection • Graphical Monitoring and Control • Instant Messaging • Aspirating Smoke Detectors • Industrial Signaling • Voice Evacuation • Smoke Control • Fire Suppression • Intercom • Timekeeping • CO Detection • Heat Detection • Audible & Visible Signaling • Voicemail Messaging • Duct Smoke Detection • Giant Voice • Electronic Signage • Area of Rescue



Specifications p. 2  
 Control Panels p. 3  
 Option Cards p. 4  
 Power Supplies p. 6  
 Remote annunciation p. 8  
 Accessories p. 10

# iO Series Intelligent Control

iO Series life safety systems are a powerful intelligent solution for small to mid-sized buildings. Advanced analog technology delivers the benefits of flexible system installation, while a clean and easy-to-operate user interface makes panel operation and system maintenance quick and intuitive.

### The smart choice

Signature Series electronic addressing eliminates the tedium of setting dipswitches, and automatic device mapping ensures that each device resides on the system at its correct location. Meanwhile, innovative programming features allow the system designer to customize powerful built-in features to precisely suit the needs of the building owner.

### Flexibility built right in

Two fully-programmable front panel switch/LED combinations provide an added measure of flexibility. Their slide-in labels take the mystery out of custom applications, and present a clean finished appearance.

### Perfect for retrofits

iO Series is particularly well-suited to retrofit applications. All connections are made over standard wiring – no shielded cable required. This means that in most situations existing wiring can be used to upgrade a legacy control panel to iO Series technology without the expense or disruption of rewiring the entire building.

### Signals with a difference

iO Series NACs are configurable to fully support the advanced signaling technology of Edwards Genesis and Enhanced Integrity notification appliances. These devices offer precision synchronization of strobes to UL 1971 standards. For Genesis devices, enabling this feature allows connected horns to be silenced while strobes on the same two-wire circuit continue to flash until the panel is reset.

### Clear-cut remote annunciation

Remote annunciation is a strong suit of iO Series. Up to eight annunciators can be installed on a single system. Compatible annunciators include a range of LED and LCD models that provide zone or point annunciation, as well as common control capabilities.

iO Series also supports graphic annunciation with optional RA Graphic Annunciator interface modules. Each interface provides common control, indicators, and 32 LEDs.

### A complete line of accessories

iO Series life safety systems are supported by a complete line of intelligent detectors, modules and related equipment, each of which is fully tuned and tested to operate in concert with one another to provide highly reliable service and years of trouble-free operation.



## System Layout

### iO1000

Any combination of two single- or dual Signature loop modules

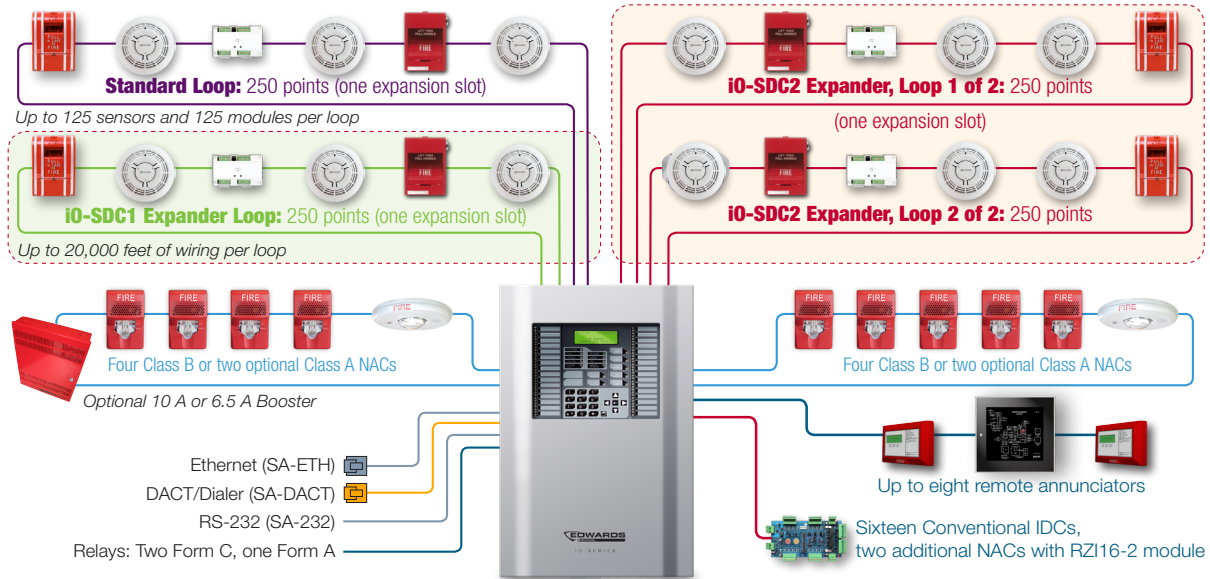

Each iO1000 panel has room for up to two Signature loop controller modules in any combination of single or dual 250-device loops. iO1000 loops support 125 detectors and 125 modules.

### iO64



Each iO64 panel ships with one Signature loop controller that supports 64 devices of any type. This panel's device capacity cannot be expanded.

Specifications	iO64	iO1000
Device loops	1 loop Class B or Class A (Styles 4, 6, 7) supporting up to 64 device addresses (any combination of detectors and modules). Maximum T-taps: 63 (each device can be on its own branch)	1 loop, expandable to 4, Class A or B (Styles 4, 6, 7), each loop supporting up to 250 device addresses (125 detectors and 125 modules max.). Addresses 1 to 125 are for detectors and addresses 126 to 250 are for modules. Maximum T-taps/loop: 124
Notification appliance circuits	2 Class B (Style Y), Class A (Style Z) optional 3.75 A FWR total at 120/230 VAC 60 Hz 3.0 A FWR total at 230 VAC 50 Hz 2.5 A FWR each max. per circuit	4 Class B (Style Y) or 2 Class A (Style Z) 6.0 A FWR total at 120/230 VAC 60 Hz 5.0 A FWR total at 230 VAC 50 Hz 2.5 A FWR each max. per circuit
Primary power	120 VAC, 60 Hz, 1.3 A. 230 VAC, 50-60 Hz, 0.62 A max.	120 VAC, 60 Hz, 2.0 A. 230 VAC, 50-60 Hz, 0.97 A max.
Base panel current standby	155 mA	172 mA
Base panel current alarm	204 mA	267 mA
Input zones	16 max.	32 max.
Remote annunciator	8 drops max., RS-485 Class B, Class A is optional Data line length: 4,000 ft. (1,219 m)	8 drops max., RS-485 Class A or B Data line length: 4,000 ft. (1,219 m)
Operating voltage	24 VDC panel	

See Data Sheet E85005-0135 for complete specification and ordering information.



## Control Panels

### Standard Features

All iO Series life safety systems feature an attractive design that fits with any decor. Its distinctive doorfront offers a contemporary look that's available with red or silver finishes. All LED indicators and its large backlit display remain easy to see at all times.

- Supports Signature Series intelligent modules and detectors
- Form C contacts for alarm and trouble, Form A for supervisory
- Electronic addressing with automatic device mapping
- Optional Ethernet port for diagnostics, programming and a variety of reports
- Two programmable switches with LEDs and custom labeling
  - Supports Genesis horn silence over two wires and UL 1971-compliant strobe synchronization
  - Supports up to eight serial annunciators, (LCD, LED-only, and graphic interface).
  - Can use existing wiring for most retrofit applications
  - Upload/download remotely or locally
  - Two-level maintenance alert reporting
  - Pre-alarm and alarm verification by point



### Dimensions

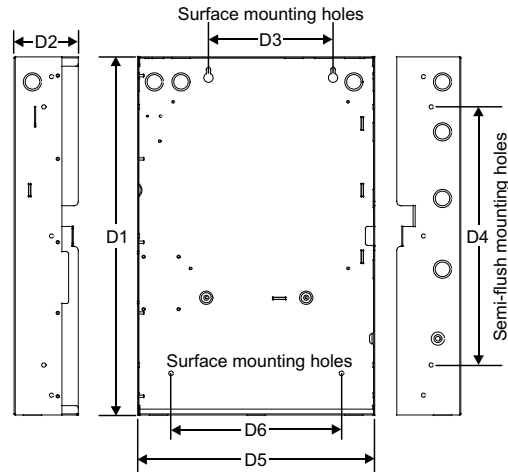

Panel dimensions, in (cm)						
Model	D1*	D2	D3	D4	D5*	D6
iO1000	28.0 (71.1)	3.85 (9.8)	9.0 (22.8)	22.0 (55.8)	15.75 (40.0)	10.25 (26.0)
iO64	21.50 (54.6)	3.85 (9.8)	7.5 (19.0)	15.5 (39.4)	14.25 (36.2)	10.25 (26.0)

\* Add 1-1/2 in. (3.81 cm) to D1 and D5 dimensions for trim kit.

### iO1000 Intelligent Multi-Loop Systems, Data Sheet E85005-0135

IO1000G	Four loop system with one 250-point loop installed. 110v, gray door.	<input type="checkbox"/>
IO1000G-2	Four loop system with one 250-point loop installed. 230v, gray door.	<input type="checkbox"/>
IO1000G-2-PG	Four loop system with one 250-point loop installed. 230v, gray door, Portuguese.	<input type="checkbox"/>
IO1000G-2-SP	Four loop system with one 250-point loop installed. 230v, gray door, Spanish.	<input type="checkbox"/>
IO1000G-CA	Four loop system, one 250-point loop installed. 110v, gray door, LED strips, Canada.	<input type="checkbox"/>
IO1000GD	Four loop system, one 250-point loop installed. 110v, gray door, with dialer.	<input type="checkbox"/>
IO1000G-F	Four loop system, one 250-point loop. 110v, gray door, LED strips, French Canada.	<input type="checkbox"/>
IO1000G-PG	Four loop system with one 250-point loop installed. 110v, gray door, Portuguese.	<input type="checkbox"/>
IO1000G-SP	Four loop system with one 250-point loop installed. 110v, gray door, Spanish.	<input type="checkbox"/>
IO1000R	Four loop system with one 250-point loop installed. 110v, red door.	<input type="checkbox"/>
IO1000R-2	Four loop system with one 250-point loop installed. 230v, red door.	<input type="checkbox"/>
IO1000RD	Four loop system, one 250-point loop installed. 110v, red door, with dialer.	<input type="checkbox"/>

### iO64 Intelligent Single Loop Systems, Data Sheet E85005-0135

IO64G	One loop system with one 64-point loop installed. 110v, gray door.	<input type="checkbox"/>
IO64G-2	One loop system with one 64-point loop installed. 230v, gray door.	<input type="checkbox"/>
IO64G-2-PG	One loop system with one 64-point loop installed. 230v, gray door, Portuguese.	<input type="checkbox"/>
IO64G-2-SP	One loop system with one 64-point loop installed. 230v, gray door, Spanish.	<input type="checkbox"/>
IO64GD	One loop system, one 64-point loop installed. 110v, gray door, with dialer..	<input type="checkbox"/>
IO64GL	One loop system, one 64-point loop installed. 110v, gray door, English Canada.	<input type="checkbox"/>
IO64GL-F	One loop system, one 64-point loop installed. 110v, gray door, French Canada.	<input type="checkbox"/>
IO64G-PG	One loop system with one 64-point loop installed. 110v, gray door, Portuguese.	<input type="checkbox"/>
IO64G-SP	One loop system with one 64-point loop installed. 110v, gray door, Spanish.	<input type="checkbox"/>
IO64R	One loop system with one 64-point loop installed. 110v, red door.	<input type="checkbox"/>
IO64R-2	One loop system with one 64-point loop installed. 230v, red door.	<input type="checkbox"/>
IO64RD	One loop system, one 64-point loop installed. 110v, red door, with dialer.	<input type="checkbox"/>

SUBMIT



## Option Cards



SA-CLA  
Class A Module

iO-SDC2 Loop Expander Card

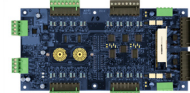
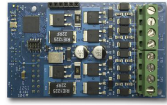

RZI16-2 Remote Zone Interface

SA-232 RS-232  
interface



iO-Series panels are supported by a complete line of modules and related equipment that enhance performance and extend system capabilities. Option cards are easy to install and set up. They simply plug directly into the control panel main circuit board or are connected to it with a ribbon cable. After installation, terminals remain easily accessible for quick connection of field wiring. The cabinet provides ample room for wire routing, keeping wiring neat and easy to service at all times.

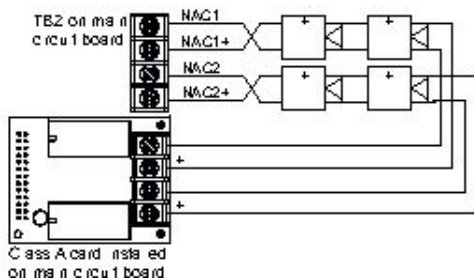

### SA-CLA Class A Module

The SA-CLA card provides Class A capability for NAC and annunciator wiring. Its terminal block provides the wiring connection for NAC return wiring. The card is required for annunciator Class A wiring even though this wiring does not return to the SA-CLA card. The SA-CLA is compatible with iO64 control panels only. iO1000 panels are Class A ready. The SA-CLA is installed directly to the control panel circuit board using its plastic standoffs and plug connection.

SA-CLA Class A adapter module. Provides Class A capacity on NACs. Mounts in cabinet on main board.

### SA-ETH Ethernet Interface Card

The SA-ETH card provides a standard 10/100 Base T Ethernet network connection for connecting to an intranet, a local network, or the Internet. The card can be used to upload and download panel configuration, history, and current status from the iO-CU to the panel over the network.

The Ethernet card is installed on the plastic assembly and connects to the main circuit board via a ribbon cable.

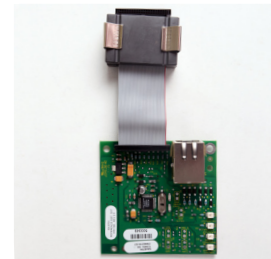

SA-ETH Ethernet Port, Slave, for Ethernet connection to local area networks. Mounts in cabinet on base plate.

### SA-232 RS-232 interface

The SA-232 card provides an RS-232 interface with iO-Series panels. It can be used for connecting a printer to the control panel to print system events. The card also can be used for connecting a computer to download a configuration program from the iO-CU to the control panel.

The RS-232 card is installed on the plastic assembly and connects to the main circuit board via a ribbon cable.



SA-232 Serial Port (RS-232), for connection to printers & computers, mounts in cabinet to base plate

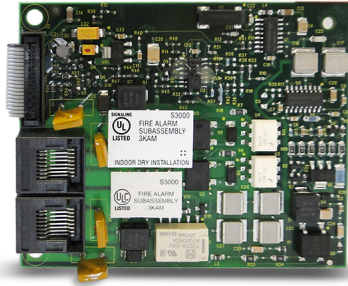

**SA-DACT Dialer**

The SA-DACT provides communications between the control panel and the central station over a telephone line system. It transmits system status changes (events) to a compatible digital alarm communicator receiver over the public switched telephone network. The dialer is capable of single, dual, or split reporting of events to two different account and telephone numbers. The modem feature of the SA-DACT can also be used for uploading and downloading panel configuration, history, and current status to a PC running the iO-CU.

The dialer phone lines connect to connectors on the dialer's main circuit board. Phone line 1 connects to connector J4 and phone line 2 connects to connector J1.

SA-DACT Dual Line Dialer/Modem, supports Contact ID, mounts in cabinet on base plate

**SMK Smoke Power Converter**

The SMK Smoke Power Converter Module provides a backup power source for two-wire smoke circuits connected to a Signature data circuit. The SMK monitors the operating power from the power supply. When power begins to degrade, the SMK provides the necessary operating voltage to the two-wire smoke detection circuits.

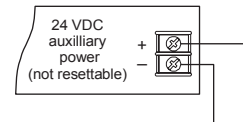

SMK Smoke Power Converter Module

**Loop Expander Cards**

The system provides one Signature device loop circuit with a total capacity of 125 detectors and 125 module addresses. The loop circuit is supervised for opens, shorts, and grounds.

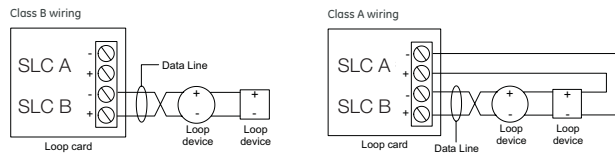

iO-SDC1 Expansion module, one 250-device loop.

iO-SDC2 Expansion module, two 250-device loops, 500 devices total. For iO1000 only.

**Remote Zone Interface**

The RZI16-2 Addressable Remote Zone Interface Module is an addressable device that provides connections for sixteen Class B Initiating Device Circuits and two Class B Supervised Output Circuits. The inputs and outputs can be configured individually for several device types. It requires 18 consecutive addresses on the Signaling Line Circuit (SLC). Addresses are assigned electronically. There are no address switches to set. The RZI16-2 incorporates two 8-segment DIP switches that are used to select the Alarm or Supervisory default device type for each of the 16 IDC circuits. The module also includes one 4-segment DIP switch used to select the default Relay or NAC output device type. Device types other than the default are accomplished through programming.

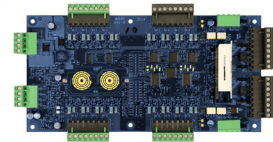

RZI16-2 Remote Zone Interface Module. 16 Class B IDCs, 2 Class B Output. Includes bracket.

**SUBMIT**



# Power Supplies

## Remote Booster Power Supply



The Remote Booster Power Supply is a self-contained 24 Vdc power supply designed to augment fire alarm audible and visual power requirements as well as provide power for auxiliary, access control and security applications. The booster contains all of the necessary circuits to monitor and charge batteries, control and supervise four Class B or two Class A NAC circuits and monitor two controlling inputs from external sources.

Simple switch selection provides a wide variety of operational configurations. Each remote booster power supply is supplied with its own enclosure providing ample space for additional interface modules and battery compartment.

When used with Genesis Notification appliances, the booster provides the ability to synchronize strobes as well as horn signals. The booster flexibility allows synchronization with upstream devices, or, the booster may be used to synchronize downstream devices, as well as other boosters and their connected devices.

BPS notification appliance circuits easily configure for either of two signaling rates: 3-3-3 temporal or continuous. This makes the BPS ideal for applications requiring signaling rates not available from the main panel. It also allows independent setup of a notification appliance circuit without interfering with the main panel and its initiating circuits. In addition to the generated signal rates, the BPS can also be configured to follow the signal rate of the main panel's notification appliance circuit. This allows seamless expansion of existing NACs.

For comprehensive configuration and wiring details, refer to the BPS Application Guide, 85001-0582.

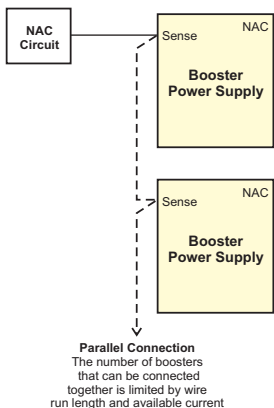

<input type="checkbox"/>	BPS6A	6.5 Amp Booster Power Supply	Data Sheet E85005-0125
<input type="checkbox"/>	BPS6A/230	6.5 Amp Booster Power Supply (220V)	Data Sheet E85005-0125
<input type="checkbox"/>	BPS10A	10 Amp Booster Power Supply	Data Sheet E85005-0125
<input type="checkbox"/>	BPS10A/230	10 Amp Booster Power Supply (220V)	Data Sheet E85005-0125
<input type="checkbox"/>	3-TAMP	Tamper switch	Data Sheet E85005-0125

**SUBMIT**



IO Series  
Intelligent Control

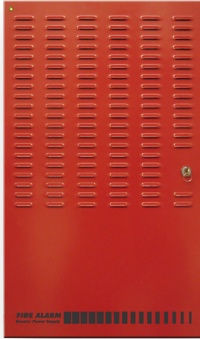

### Auxiliary Power Supply (APS)

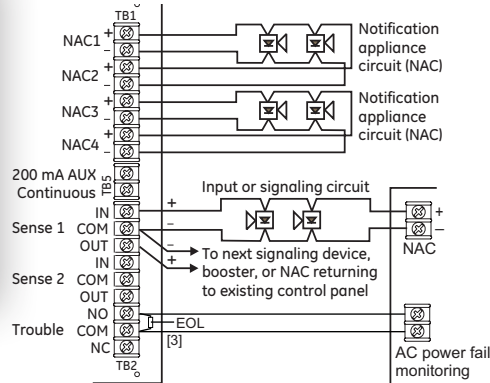

The Auxiliary Power Supply (APS) is a self-contained 24 Vdc power supply designed to augment fire alarm audible and visual power requirements as well as provide auxiliary power for life safety and security applications. The APS contains all of the necessary circuits to monitor and charge batteries, control and supervise four Class B or two Class A NAC circuits and monitor two controlling inputs from external sources.

APS6A	6.5 Amp Auxiliary Power Supply	Data Sheet E85005-0127	<input type="checkbox"/>
APS6A/230	6.5 Amp Auxiliary Power Supply (220V)	Data Sheet E85005-0127	<input type="checkbox"/>
APS10A	10 Amp Auxiliary Power Supply	Data Sheet E85005-0127	<input type="checkbox"/>
APS10A/230	10 Amp Auxiliary Power Supply (220V)	Data Sheet E85005-0127	<input type="checkbox"/>



### Batteries and Battery Cabinets

12 Volt Batteries	<input type="checkbox"/> 12V4A (4.5 Ah)	<input type="checkbox"/> 12V24A (26 Ah)	<input type="checkbox"/> 12V17A (18 Ah)	Data Sheet E85005-0127	<input type="checkbox"/>
	<input type="checkbox"/> 12V6A5 (7.2 Ah)	<input type="checkbox"/> 12V10A (11 Ah)		Data Sheet E85005-0127	<input type="checkbox"/>
Battery Cabinet	<input type="checkbox"/> BC-1 (holds up to two 40 Ah batteries)			Data Sheet E85005-0127	<input type="checkbox"/>

Initiating  
Devices

Notification  
Appliances

Hazardous Location  
Devices

Door Holders  
& Relays

SUBMIT



## Remote annunciation

Edwards R-Series Annunciators are high-performance remote annunciators that provide status indication and common controls for compatible fire alarm control panels, including iO-Series small analog fire alarm systems. This family of annunciators offers LCD or LED annunciation. Models are available with and without common controls.



There are three R-Series annunciator models, plus an LED-based expander. Up to two expanders can be connected to any annunciator. The expander includes 24 pairs of LEDs that extend the capabilities of any of the annunciators.

All annunciator models include status LEDs and an internal buzzer. Two models have an LCD text display, and one has 16 pairs of LEDs for zone annunciation. LCD models feature a large back-lit, four by twenty character per line, super-twist liquid crystal display.

R-Series annunciators and expanders are mounted on a standard 4-inch square electrical box, using the included mounting ring. They can also be surface mounted in locking steel enclosures. Three different enclosures are available.

A keyswitch and graphic annunciator interface is available for R-Series annunciator applications. The keyswitch enables or disables common controls. The graphic annunciator interface cards supports 32 LEDs and 16 switches on the graphic panel display.

### Wiring, Class A

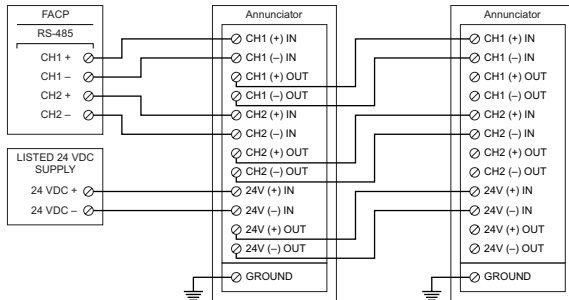

### Wiring, Class B

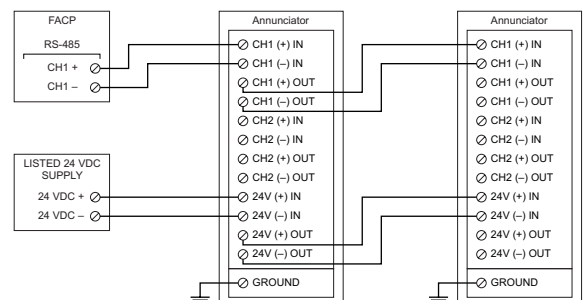

<input type="checkbox"/>	RLCD	LCD text annunciator without common controls. English.	Data Sheet E85005-0128
<input type="checkbox"/>	RLCD-R	LCD text annunciator without common controls. English. Red.	Data Sheet E85005-0128
<input type="checkbox"/>	RLCDF	LCD text annunciator without common controls. French.	Data Sheet E85005-0128
<input type="checkbox"/>	RLCD-C	LCD text annunciator with common controls. English.	Data Sheet E85005-0128
<input type="checkbox"/>	RLCD-CR	LCD text annunciator with common controls. English. Red.	Data Sheet E85005-0128
<input type="checkbox"/>	RLCD-CF	LCD text annunciator with common controls. French.	Data Sheet E85005-0128
<input type="checkbox"/>	RLED-C	16-pair LED zone annunciator with common controls. English.	Data Sheet E85005-0128
<input type="checkbox"/>	RLED-CR	16-pair LED zone annunciator with common controls. English. Red.	Data Sheet E85005-0128
<input type="checkbox"/>	RLED-CF	16-pair LED zone annunciator with common controls. French.	Data Sheet E85005-0128
<input type="checkbox"/>	RLED24	24-pair LED zone expander with expander cable and zone card insert.	Data Sheet E85005-0128
<input type="checkbox"/>	RLED24R	24-pair LED zone expander with expander cable and zone card insert. Red.	Data Sheet E85005-0128
<input type="checkbox"/>	RKEY	Remote key switch on plate for enabling common controls (Lock/Unlock).	Data Sheet E85005-0128





## Annunciator Enclosures

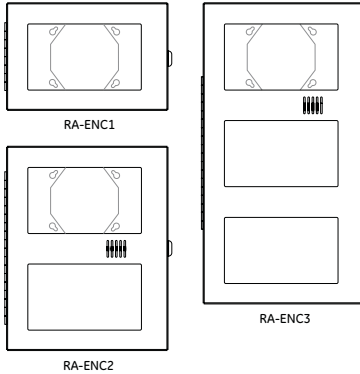

The RA Remote Annunciator Enclosures provide secure, surface mounted protection for annunciators and extenders. Each consists of a back plate, hinged cover, and key lock. The enclosures are 16-gauge welded steel with a white, painted finish. Each enclosure includes a security lock and two keys. The two- and three-position enclosures have wiring channels for correct routing of interconnections. The enclosures attach to a standard electrical box, and provide a mounting lip that takes the place of the integral mounting ring supplied with the annunciators and expanders.

RA-ENC1	One-position enclosure for Remote Annunciator.	Data Sheet E85005-0128	<input type="checkbox"/>
RA-ENC2	Two-position enclosure for Remote Annunciator and one Remote Expander.	Data Sheet E85005-0128	<input type="checkbox"/>
A-ENC3	Three-position enclosure for Remote Annunciator and two Remote Expanders.	Data Sheet E85005-0128	<input type="checkbox"/>
LSRA-SB	Surface Mount Box - for R Series single units.	Data Sheet E85005-0128	<input type="checkbox"/>

## Graphic Annunciation

The GCI series of graphic Annunciator drivers allow iO control panels to display events on an LED-based graphic annunciator. The GCI annunciator card supports 32 LEDs on the graphic panel display. It includes status LEDs and an internal buzzer. The graphic card is supplied with snap track mounting. It is attached to a plastic mounting rail that requires two EIA panels.

The annunciator communicates with the control panel on the RS 485 data riser, which can be configured for Class A or Class B communication. The annunciator does not provide ground fault isolation. The driver card communicates with and is powered by the control panel or by an approved power supply. Always ensure that National and Local approvals and requirements are met when selecting a graphic panel supplier.

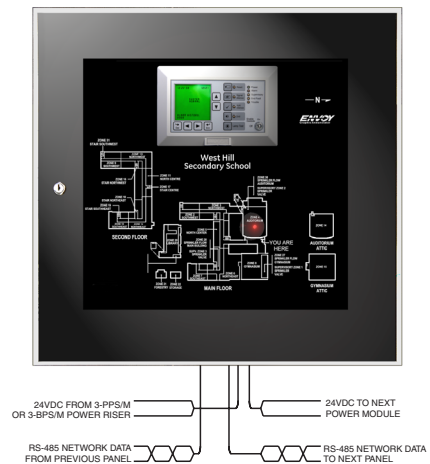

GCI	Graphic Annunciator Driver	Data Sheet E85005-0135	<input type="checkbox"/>
-----	----------------------------	------------------------	--------------------------

**SUBMIT**



- Combination CO/Fire Detectors p. 12
- Fire Detectors p. 13
- Duct Smoke Detectors p. 13
- Detector Bases p. 14
- Detector Accessories p. 15
- Input/Output Modules p. 16
- Pull Stations p. 22

### Signature Series

# Intelligent Analog Initiating Devices

**iO Series Signature Series** intelligent analog-addressable system is an entire family of life safety detectors as well as mounting bases, multiple-function input and output modules, and user-friendly maintenance and service tools.

Making the most of the latest detection technology, Signature Series detectors continually monitor the protected space with their on-board sensors, which are finely tuned to detect the characteristic properties of combustion. Detection data is gathered and run through sophisticated algorithms that track the sensor readings over time to known signatures of fires. Only when a match is found will an alarm condition occur. This means that a Signature Series detector can distinguish between a harmless puff of dust and a wisp of smoke; between hot, humid weather and a serious life safety condition.

**Self-diagnostics and History Log** – Signature Series devices constantly run self-checks to provide important maintenance information. The results of these checks are automatically updated and permanently stored in the device's non-volatile memory.

**Automatic Device Mapping** – The Signature Loop Controller learns where each device's serial number address is

installed relative to other devices on the circuit. This mapping function is invaluable for tracking down unexpected or missing device addresses, or finding changes to wiring. The Configuration Utility program also uses this mapping feature to produce system layout or As-Built drawings showing such details as branch wiring (T-taps), device types and their addresses.

**Fast Stable Communication** – Built-in intelligence means less information needs to be sent between the device and the Signature Loop Controller, making the circuit less sensitive to noise and wire characteristics. This renders shielded wiring unnecessary. In fact, existing wiring can be used by Signature Series devices in most retrofit situations.

**Testing & Maintenance** – Each detector automatically identifies when it is dirty or defective and causes a “dirty detector” message. The detector's sensitivity measurement can also be transmitted to the loop controller. A sensitivity report may be printed to satisfy NFPA sensitivity measurements. The user-friendly maintenance program shows the current state of each detector and other pertinent messages. When the CO sensor's electrochemical cell reaches its end of life, the detector signals a trouble condition to the control panel.

### iO Series Signature Device loop

iO Series control panels provide one device loop circuit that can be used with any mix of Signature Series detectors and modules. The iO1000 panel can be expanded to provide a second loop. All loop circuits are supervised for opens, shorts, and grounds.

#### Circuit specifications

Device loops	1 loop, expandable to 2, Class A or B, each loop supporting up to 250 device addresses
Com. line voltage	Maximum 20 V peak-to-peak
Circuit current	0.5 A max
Circuit impedance	66Ω total, 0.5 μF, max
Isolators	64 maximum

Typical Wiring

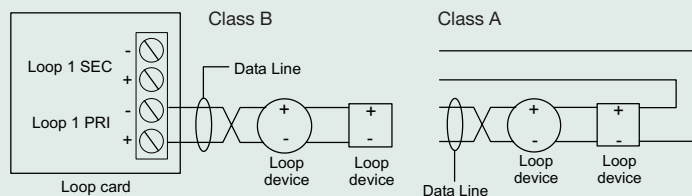



SUBMIT



iO Series  
Intelligent Control

Initiating  
Devices

## Carbon Monoxide and Fire Detectors

*In addition to integrated smoke and heat sensors, Signature Series combination life safety devices include electrochemical carbon dioxide sensors. CO detection has rapidly become a standard part of life safety strategies everywhere. Monitored CO detection is becoming mandated with increasing frequency in all types of commercial applications, but particularly in occupancies such as hotels, rooming houses, dormitories, day care facilities, schools, hospitals, assisted living facilities, and nursing homes. In fact, more than half of the U.S. population already lives in states requiring the installation of CO detectors in some commercial occupancies. This is because carbon monoxide is the leading cause of accidental poisoning deaths in America. Known as the "Silent Killer," CO is odorless, tasteless, and colorless. It claims nearly 500 lives, and results in more than 15,000 hospital visits annually.*

### Intelligent Carbon Monoxide (CO) Detector

The SIGA-COD detects carbon monoxide from any source of combustion and analyzes the sensor data to determine when to initiate a CO-related life safety event.

<input type="checkbox"/>	SIGA-COD	Intelligent Carbon Monoxide Detector	Data Sheet E85001-0648
--------------------------	----------	--------------------------------------	------------------------

### Intelligent Multi-criteria Optical Smoke Detector with CO Sensor

Includes an multi-criteria optical smoke sensor and a carbon monoxide sensor. The detector analyzes the smoke sensor independently from the CO sensor, and can report a smoke/fire alarm separate from a CO-related life safety alarm.

<input type="checkbox"/>	SIGA-OSCD	Intelligent Multi-criteria Smoke and CO Detector	Data Sheet E85001-1002
--------------------------	-----------	--	------------------------

### Intelligent Multi-criteria Optical Smoke Detector with Heat and CO Sensors

Includes a multi-criteria smoke sensor, a fixed-temperature heat sensor, and a carbon monoxide sensor. The detector analyzes the smoke and heat sensors independently from the CO sensor, and can report a smoke/fire alarm separate from a CO-related life safety alarm.

<input type="checkbox"/>	SIGA-OSHCD	Intelligent Multi-criteria Smoke, Heat, and CO Detector	Data Sheet E85001-1004
<input type="checkbox"/>	SIGA-OSHCDB	Intelligent Multi-criteria smoke, heat and CO detector (Black)	Data Sheet E85001-1004



## Fire Detectors

### Intelligent Multi-criteria Optical Smoke Detector

The workhorse of modern fire alarm systems, this devices includes a multi-criteria optical smoke sensor to detect smoke.

SIGA-OSD	Intelligent Multi-criteria Smoke Detector	Data Sheet E85001-1001	<input type="checkbox"/>
----------	---	------------------------	--------------------------

### Intelligent Rate-of-rise and Fixed Temperature Heat Detector

Includes a rate-of-rise and a fixed-temperature sensor to detect heat from fire.

SIGA-HRD	Intelligent fixed temperature/Rate-of-rise heat detector	Data Sheet E85001-0647	<input type="checkbox"/>
SIGA-HFD	Intelligent fixed temperature heat detector	Data Sheet E85001-0647	<input type="checkbox"/>
SIGA-HCD	Intelligent ROR/fixed heat and CO detector	Data Sheet E85001-0647	<input type="checkbox"/>

### Intelligent Multi-criteria Optical Smoke and Heat Detector

Contains a fixed-temperature heat sensor to detect heat from fire and a multi-criteria optical smoke sensor to detect smoke. Unlike simple multi-criteria detectors, the SIGA-OSHD can report the heat and photo elements as separate event types — or together. This permits the photo element of the detector to report, for example, a supervisory event during the day, and an alarm event at night – while the heat element always reports an alarm.

SIGA-OSHD	Intelligent Multi-criteria Smoke and Heat Detector	Data Sheet E85001-1003	<input type="checkbox"/>
SIGA-OSHDB	Intelligent Multi-criteria Smoke and Heat Detector (Black)	Data Sheet E85001-1003	<input type="checkbox"/>



## Duct Smoke Detectors

### SuperDuct Detectors

Less than two inches deep, SuperDuct intelligent smoke detectors are ideal for installation in ductwork, where space is always at a premium. Offering the most advanced and most reliable performance in its class, SuperDuct represents the perfect balance of practical design and advanced technology.

SuperDuct detectors feature a unique design that speeds installation and simplifies maintenance. Removable dust filters, conformally coated circuit boards, and optional water-resistant gaskets keep contaminants away from components, ensuring years of trouble-free service. When cleaning is required, the assemblies come apart easily and snap back together in seconds.

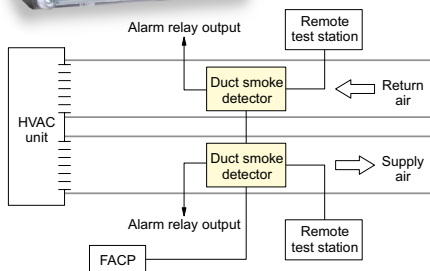

SIGA-SD	Intelligent SuperDuct Detector	Data Sheet E85001-0584	<input type="checkbox"/>
SD-PH	Protective housing for high humidity environments	Data Sheet E85001-0584	<input type="checkbox"/>
Sampling Tubes	<input type="checkbox"/> SD-T8 (8") <input type="checkbox"/> SD-T18 (18") <input type="checkbox"/> SD-T24 (24") <input type="checkbox"/> SD-T36 (36") <input type="checkbox"/> SD-T42 (42") <input type="checkbox"/> SD-T60 (60") <input type="checkbox"/> SD-T78 (78") <input type="checkbox"/> SD-T120 (120")		<input type="checkbox"/>
Remote Test Stations	<input type="checkbox"/> SD-TRM (magnetic) <input type="checkbox"/> SD-TRM (keyed) <input type="checkbox"/> SIGA-LED (Remote alarm LED)		<input type="checkbox"/>
Accessories	<input type="checkbox"/> SD-GSK (cover gasket kit) <input type="checkbox"/> SD-MAG (Test magnet kit) <input type="checkbox"/> SD-VTK (Air velocity test kit, stoppers only) <input type="checkbox"/> SIGA-SDPCB (PCB/Signature sensor kit)		<input type="checkbox"/>

**SUBMIT**



## Detector Bases

### Audible (Sounder) Bases



Signature Series Sounder Bases add audible output functions to Signature Series smoke and CO detectors. Bases can operate as independent local alarms, or as part of a zone or system alarm with synchronized audible output. The SIGA-AB4G-LF is UL listed for sleeping areas and other applications requiring 520 Hz low frequency audible tones.

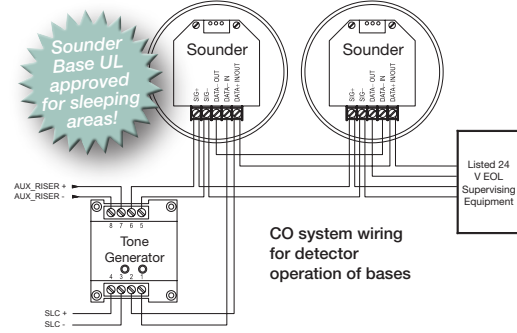

CO system wiring for detector operation of bases

<input type="checkbox"/>	SIGA-AB4G-LF	Low Frequency Audible (Sounder) Base for CO and Fire Detectors	Data Sheet E85001-0640
<input type="checkbox"/>	SIGA-AB4GT	Audible (Sounder) Base for CO and Fire Detectors	Data Sheet E85001-0640
<input type="checkbox"/>	SIGA-TCDR	Temporal Pattern Generator for SIGA-AB4GT, SIGA-AB4G-LF	Data Sheet E85001-0640
<input type="checkbox"/>	SIGA-AB4G	Audible (Sounder) Base	Data Sheet E85001-0640
<input type="checkbox"/>	AB4G-SB	Surface Box for Audible Bases	Data Sheet E85001-0640

### Standard Detector Bases



Standard detector bases provide roomside wiring terminals. They mount to North American one-gang box, 3½ or 4-inch octagon boxes, or 4-inch square electric box. Bases for 4-inch square boxes include the SIGA-TS4 Trim Skirt to conceal the electric box and provide a finished appearance.

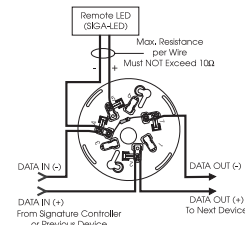

<input type="checkbox"/>	<input type="checkbox"/> SIGA-SB	<input type="checkbox"/> SIGA-SB4 (with trim skirt)	Standard Detector Base	Data Sheet E85001-0245
--------------------------	----------------------------------	---	------------------------	------------------------

### Isolator Detector Base



Isolator detector bases provide room-side wiring terminals and includes a built-in line fault isolator. Models with integral switches allow the detector to be removed from its base without causing the isolator to operate. Mounts to North American one-gang box, 3½ or 4-inch octagon boxes, or 4-inch square electrical boxes. Bases for 4-inch square boxes include the SIGA-TS4 Trim Skirt to conceal the electrical box and provide a finished appearance.

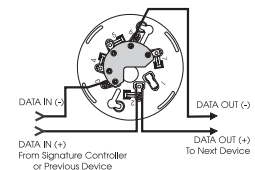

<input type="checkbox"/>	<input type="checkbox"/> SIGA-IB	<input type="checkbox"/> SIGA-IB4 (with trim skirt)	Isolator Detector Base	Data Sheet E85001-0245
--------------------------	----------------------------------	---	------------------------	------------------------

### Relay Detector Base



This base includes a relay. Normally-open or closed operation is selected during installation. The dry contact is rated for 1 amp (pilot duty) @ 30 Vdc. The relay's position is supervised to avoid accidentally jarring it out of position. The relay base does not support the SIGA-LED remote LED. It mounts to North American one-gang boxes, 3½ or 4-inch octagon boxes, or 4-inch square electrical boxes. Bases for 4-inch square boxes include the SIGA-TS4 Trim Skirt to conceal the electrical box and provide a finished appearance.

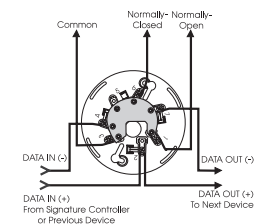

<input type="checkbox"/>	<input type="checkbox"/> SIGA-RB	<input type="checkbox"/> SIGA-RB4 (with trim skirt)	Relay Detector Base	Data Sheet E85001-0245
--------------------------	----------------------------------	---	---------------------	------------------------



## Detector Accessories



### SIGA-TCDR Temporal Pattern Generator

The SIGA-TCDR Temporal Pattern Generator is an addressable device that generates sound patterns for carbon monoxide (CO) and fire signals for the AB4GT and AB4G-LF sounder base. The control panel sends synchronization and channel commands to the SIGA-TCDR; the channel selection determines the pattern.

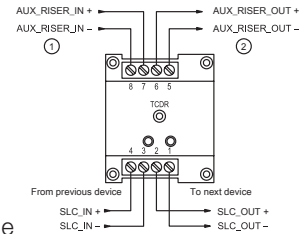

SIGA-TCDR	Temporal Pattern Generator for AB4GT Sounder Base	Data Sheet E85001-0623	<input type="checkbox"/>
-----------	---	------------------------	--------------------------

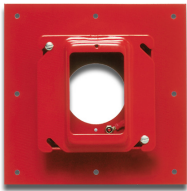

### Detector Mounting Plate

The SIGA-DMP Detector Mounting Plate is a 7-inch (178mm) square mounting plate designed to provide convenient mounting of Signature Series intelligent smoke detectors in raised floor or plenum applications. The detector mounting plate may also be installed in low velocity ducts that have a maximum width of up to 36-inches (915mm) and a maximum height of up to 36-inches (915mm).

SIGA-DMP	Detector Mounting Plate	Data Sheet E85001-0255	<input type="checkbox"/>
----------	-------------------------	------------------------	--------------------------



### Remote LED

The remote LED connects to the SIGA-SB or SIGA-SB4 Standard Base. It features a North American size one-gang plastic faceplate with a white finish and red alarm LED.

SIGA-LED	Remote Alarm LED	Data Sheet E85001-0245	<input type="checkbox"/>
----------	------------------	------------------------	--------------------------



### Trim Skirt

Use the SIGA-TS Trim Skirt to give Signature detectors a finished look and hide surface imperfections around the detector's base. Supplied with all four-inch detector bases, the SIGA-TS4 can also be ordered separately. Use the black model with SIGA-IPHSB.

SIGA-TS	Detector Trim Skirt (white)	Data Sheet E85001-0245	<input type="checkbox"/>
SIGA-TSB	Detector Trim Skirt (black)	Data Sheet E85001-0245	<input type="checkbox"/>
SIGA-TS4	Detector Trim Skirt (white) – for 4-inch box	Data Sheet E85001-0245	<input type="checkbox"/>



### Detector Guard

Constructed of sturdy 16-gauge steel, the SIGA-GRD Smoke Detector Guard is designed for preventing smoke detectors from damage or tampering. The advanced louver system allows smoke detectors to be installed at their listed spacing and has no effect on operating sensitivity.

SIGA-GRD	Smoke Detector Guard	Data Sheet E85001-1005	<input type="checkbox"/>
SIGA-DGSB	Detector Guard Surface Mount Accessory	Data Sheet E85001-1005	<input type="checkbox"/>

SUBMIT



Signature Series

## Input/Output Modules

**Signature Series** input/output modules are extremely flexible and powerful devices that gather analog information from the slave devices connected to them and convert this data into digital signals. They are available in models that mount in standard one- or two-gang electrical boxes, as well as versions that plug into UIO motherboards.

The actual function of each module is determined by its installer-selected personality code. This is downloaded to the module from the Signature Loop Controller during system configuration. Because they are intelligent devices, all decisions are made at the module. This allows lower communication speed but very fast control panel response time and less sensitivity to line noise and loop wiring properties. As a result, twisted or shielded wire is not required.

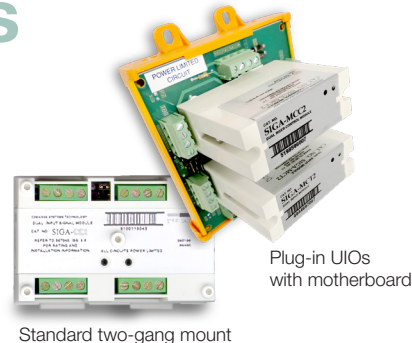

Standard two-gang mount

Plug-in UIOs with motherboard

Application	Module
Waterflow Switches	Waterflow/Tamper Module
Class A indicating and initiating circuits, two-wire smoke detectors	Universal Class A/B Module
Class B Initiating Circuits:	Class B Input Module
Door Closers, Fans, Dampers	Monitor Module
	Control Relay Module
Telephone Power and Audible/Visual Signal Power Selector, Strobe Synchronization	Signal Module
Sounder Base power	Reversal Relay Module
Fire Suppression	Releasing Module
Fault detection	Isolator Module

**Signature Series intelligent input/output modules feature multiple user-set personality codes that define the module's behavior.**

### Module mounting and installation options

Signature Series input/output modules are available in models that feature two mounting options: standard mount and plug-in.

Standard mount models are installed to North American two-gang or one-gang electrical boxes, making them ideal for locations where only one module is required. Separate I/O and data loop connections are made to each module.

Plug-in UIO modules mount to UIO motherboards. Two- and six-module UIO motherboards are available, making them ideal for installations

where more than one module is required. Motherboards can accommodate individual risers for each on-board module, or shared risers in any combination with their UIO modules. All wiring connections are made to terminal blocks on the motherboard. UIO assemblies may be mounted in either cabinets, or standard electrical enclosures.

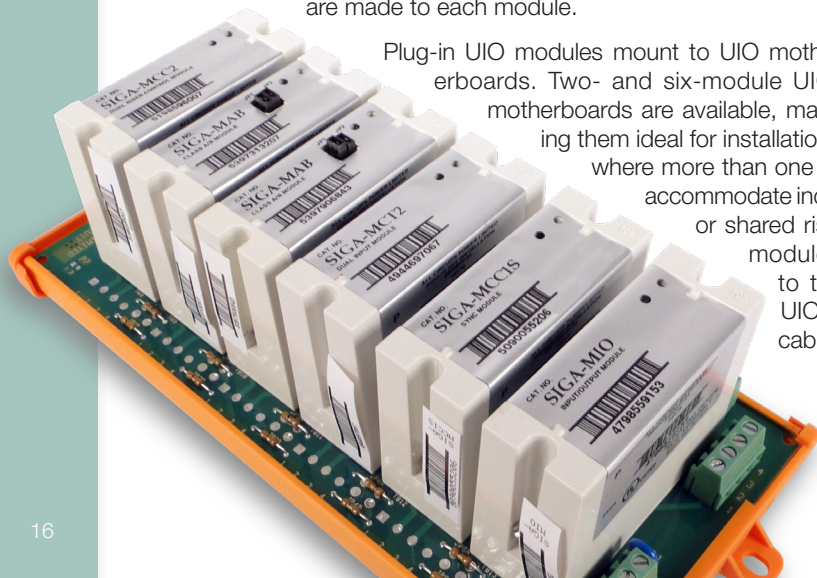
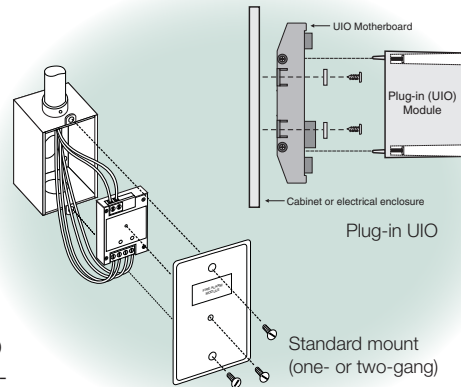





## Universal Class A/B Module

The Universal Class A/B Module is used to connect initiating, appliance, or two-wire smoke circuits in either Class A or Class B configurations. The plug-in version can also be used as a Class A dry contact initiating device circuit. The actual function of this module is determined by the “personality code” selected by the installer. Up to fifteen personalities are available.



SIGA-UM	Universal Class A/B Module (Two-gang standard mount)	Data Sheet E85001-0275	<input type="checkbox"/>
SIGA-MAB	Universal Class A/B UIO (Plug-in) Module	Data Sheet E85001-0275	<input type="checkbox"/>

## Class B Input Module

The Class B Input Module is used to connect Class B normally-open Alarm, Supervisory, or Monitor type dry contact initiating device circuits. The standard-mount version is available with either one or two input connections. The plug-in version accepts two input connections. The actual function of this module is determined by the “personality code” selected by the installer. A total of four personalities are available.



SIGA-CT1	Single Input Module (One-gang standard mount)	Data Sheet E85001-0241	<input type="checkbox"/>
SIGA-CT1HT	Single Input Module, high temperature rating (One-gang standard mount)	Data Sheet E85001-0241	<input type="checkbox"/>
SIGA-CT2	Dual Input Module (One-gang standard mount)	Data Sheet E85001-0241	<input type="checkbox"/>
SIGA-MCT2	Dual Input UIO (Plug-in) Module	Data Sheet E85001-0241	<input type="checkbox"/>

## Synchronization Output Module

The Synchronization Output Module is an intelligent device that connects a supervised output circuit to a 24 Vdc riser. The output wiring is monitored for open circuits and short circuits. A short circuit will cause the fire alarm control panel to inhibit the activation of the audible/visual signal circuit so the riser is not connected to the wiring fault. Upon command from the Signature loop controller, the Auto-Sync Output Module connects the output circuit to the riser input. The output circuit operates polarized audible and visual appliances that have an adjustable resynchronizing feature.



SIGA-CC1S	Synchronization Output Module (One-gang standard mount)	Data Sheet E85001-0543	<input type="checkbox"/>
SIGA-MCC1S	Synchronization Output UIO (Plug-in) Module	Data Sheet E85001-0543	<input type="checkbox"/>

**SUBMIT**



*Signature Series*

## Input/Output Modules

### Signal Module

The Signal Module is used to connect, upon command from the loop controller, supervised Class B signal or telephone circuits to their respective power inputs. Models are available with one or two power inputs. These may be either polarized 24 Vdc to operate audible and visual signal appliances, or 25 and 70V<sub>RMS</sub> to operate audio evacuation speakers and firefighter's telephones. The actual function of this module is determined by the "personality code" selected by the installer. A total of three personalities are available.



<input type="checkbox"/>	SIGA-CC1	Single Input Signal Module (Two-gang standard mount)	Data Sheet E85001-0237
<input type="checkbox"/>	SIGA-MCC1	Single Input Signal UIO (Plug-in) Module	Data Sheet E85001-0237
<input type="checkbox"/>	SIGA-CC2	Dual Input Signal Module (Two-gang standard mount)	Data Sheet E85001-0237
<input type="checkbox"/>	SIGA-MCC2	Dual Input Signal UIO (Plug-in) Module	Data Sheet E85001-0237
<input type="checkbox"/>	SIGA-CC2A	Dual Input Signal Module with Class A Operation (Two-gang mount)	Data Sheet E85001-0609
<input type="checkbox"/>	SIGA-MCC2A	Dual Input Signal UIO with Class A Operation (Plug-in) Module	Data Sheet E85001-0609

### Control Relay Module

The Control Relay Module provides a Form C dry relay contact to control external appliances such as door closers, fans, dampers etc. This device does not provide supervision of the state of the relay contact. Instead, the on-board microprocessor ensures that the relay is in the proper ON/OFF state. Upon command from the loop controller, the relay activates the normally open or normally-closed contact. This module supports only one personality: no user configuration is required.



<input type="checkbox"/>	SIGA-CR	Control Relay Module (One-gang standard mount)	Data Sheet E85001-0239
<input type="checkbox"/>	SIGA-MCR	Control Relay UIO (Plug-in) Module	Data Sheet E85001-0239
<input type="checkbox"/>	SIGA-CRH	High Power Control Relay Module	Data Sheet E85001-0644

### Polarity Reversal Relay Module

The Polarity Reversal Relay Module provides a Form C dry relay contact to power and activate a series of SIGA-AB4 Audible Sounder Bases. Upon command from the Signature loop controller, the SIGA-CRR reverses the polarity of its 24 Vdc output, thus activating all Sounder Bases on the data loop. This module supports only one personality: no user configuration is required.



<input type="checkbox"/>	SIGA-CRR	Polarity Reversal Relay Module (One-gang standard mount)	Data Sheet E85001-0239
<input type="checkbox"/>	SIGA-MCRR	Polarity Reversal Relay UIO (Plug-in) Module	Data Sheet E85001-0239

### Riser Monitor Module

The SIGA-RM1 Riser Monitor Module is an intelligent device that monitors the integrity of 24 Vdc, 25 Vac, and 70 Vac circuits, as well as telephone riser signals. Upon the loss of a signal, the Riser Monitor Module causes the fire alarm control panel to indicate an alert status. Personality codes downloaded to the Riser Monitor Module during system configuration determine its function.



<input type="checkbox"/>	SIGA-RM1	Riser Monitor Module (One-gang standard mount)	Data Sheet E85001-0535
<input type="checkbox"/>	SIGA-MRM1	Riser UIO (Plug-in) Module	Data Sheet E85001-0535



## Input/Output Module

The Input/Output Module is an intelligent device that provides the following modes of operation:

- Output with monitor input
- Input/programmable output
- Input/direct output



SIGA-IO	Input/Output Module (One-gang standard mount)	Data Sheet E85001-0533	<input type="checkbox"/>
SIGA-MIO	Input/Output UIO (Plug-in) Module	Data Sheet E85001-0533	<input type="checkbox"/>

NOTE: Not all personality selections are available, please check iO-CU help system for more information.

## Waterflow/Tamper Module

The SIGA-WTM Waterflow/Tamper Module is a two circuit intelligent module. Circuit 1 is for Class B normally-open waterflow alarm switches. When the input contact is closed for approximately 16 seconds, an “alarm” signal is sent to the loop controller. Circuit 2 is for Class B normally open dry contact supervisory and tamper switches. When the input contact is closed, an “active” signal is sent to the loop controller. Conditions on both circuits are latched at the module.



SIGA-WTM	Waterflow/Tamper Module (One-gang standard mount)	Data Sheet E85001-0297	<input type="checkbox"/>
----------	---	------------------------	--------------------------

## Isolator Module

The SIGA-IM Isolator Module is an intelligent device that allows part of the Signature data loop to continue operating in the event of a short circuit. The module can be wired into a Class A data loop at any point. A maximum of 64 isolator modules can be installed on one circuit. If a fault occurs, the isolator cuts power to all devices beyond the isolator on the loop. Once activated, the line fault isolator continuously checks the faulted side of the loop to determine if the short still exists. When the fault is cleared, the module automatically restores the entire data loop to its normal condition.



SIGA-IM	Fault Isolator Module (Two-gang standard mount)	Data Sheet E85001-0271	<input type="checkbox"/>
---------	---	------------------------	--------------------------

## Monitor Module

The SIGA-MM1 is a single-circuit intelligent module that includes a Class B normally-open dry contact. This is used for monitoring input from devices such as fans, dampers, and doors. When the input contact is closed, an “active” signal is sent to the loop controller. The active condition is not latched at the module.



SIGA-MM1	Monitor Module (One-gang standard mount)	Data Sheet E85001-0297	<input type="checkbox"/>
----------	--	------------------------	--------------------------

SUBMIT



Signature Series

# Input/Output Modules

## Universal Input/Output (UIO) Motherboards

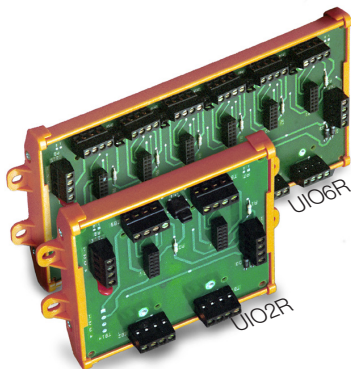

Signature Series Universal Input/Output Module Motherboards provide mounting and wiring terminations for up to six Signature Series plug-in UIO (SIGA-“M” series) modules. UIO motherboards snap into a rigid extruded track (included) with mounting pads for convenient mounting into a variety of equipment enclosures. UIO modules plug into the board and are held securely in place with captive machine screws. All field wiring connects to terminal blocks on the motherboard, which permits rapid removal and replacement of modules for troubleshooting.

The SIGA-UIO2R provides mounting and wiring terminations for up to two UIO modules, and the SIGA-UIO6R provides mounting and wiring terminations for up to six UIO modules. Both motherboards feature a riser #1 input and a riser #2 input bus. Jumpers on riser #1 input (between modules), facilitate sharing a single riser among more than one module. This significantly reduces wiring requirements. Removing the jumpers provides

separate riser inputs to each adjacent module. Riser #2 input is fixed to each module position and cannot be split.

The SIGA-UIO6 provides mounting and wiring terminations for up to six UIO modules. This motherboard provides two riser inputs that are common to all modules.

UIO motherboards mount inside the MFC-A cabinet or other suitable UL-listed electrical enclosure. Each MFC-A will hold one UIO2R motherboard or one UIO6 or UIO6R motherboard complete with their full complement of modules.

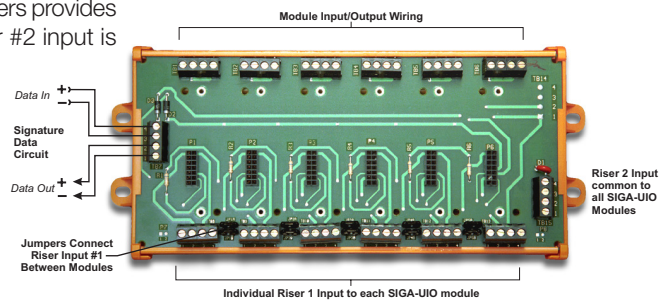

<input type="checkbox"/>	SIGA-UIO2R	Universal Input/Output Module Board with Riser Inputs — 2 Module Positions	Data Sheet E85001-0365
<input type="checkbox"/>	SIGA-UIO6R	Universal Input/Output Module Board with Riser Inputs — 6 Module Positions	Data Sheet E85001-0365
<input type="checkbox"/>	SIGA-UIO6	Universal Input/Output Module Board — 6 Module Positions	Data Sheet E85001-0365

## Related Equipment

<input type="checkbox"/>	MFC-A	Multi-function Cabinet (for UIO and Releasing modules)
<input type="checkbox"/>	27193-11	Surface Mount Box - Red, One-gang
<input type="checkbox"/>	27193-16	Surface Mount Box - White, One-gang
<input type="checkbox"/>	27193-21	Surface Mount Box - Red, Two-gang
<input type="checkbox"/>	27193-26	Surface Mount Box - White, Two-gang
<input type="checkbox"/>	235196P	Bi-polar Transient Protector (use with all Signal Modules)
<input type="checkbox"/>	SIGA-MP1	Signature Module Mounting Plate, 1 footprint
<input type="checkbox"/>	SIGA-MP2	Signature Module Mounting Plate, 1/2 footprint
<input type="checkbox"/>	SIGA-MP2L	Signature Module Mounting Plate, 1/2 extended footprint





## Releasing Module

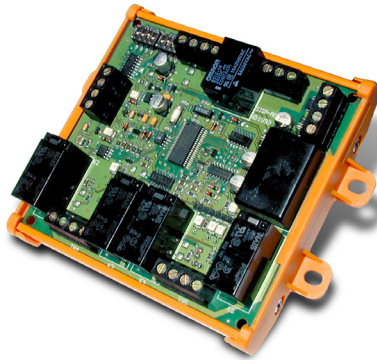

The Signature Series Releasing Module (SIGA-REL) is an analog addressable module that works with fire suppression systems designed to release extinguishing gas such as Halon. Its primary function is the control of sprinkler pre-action routines and the initiation of suppression system deluge functions. The module is easily configured in the field and offers a wide range of options that prevent the unnecessary release of extinguishing agent.

The SIGA-REL is a network component consisting of:

- Two supervised release circuits
- Two supervised pre-release circuits
- One supervised manual release input circuit
- One supervised abort circuit for N/O abort switch
- One first alarm output relay (Form C Contact)

The releasing module includes a built-in timer that inhibits the deluge function during the pre-action routine. One of four pre-action routines, may be selected by means of dip-switches on the module. The duration of automatic and manual time delays, as well as the abort time settings are also selectable with dip-switches. The SIGA-REL mounts inside an MFC-A cabinet or other suitable UL-listed electrical enclosure. Each MFC-A will hold one SIGA-REL.

Available releasing module accessories include dedicated pull stations, abort switches and service switches. Together with the SIGA-REL, they comprise a complete fire suppression package.

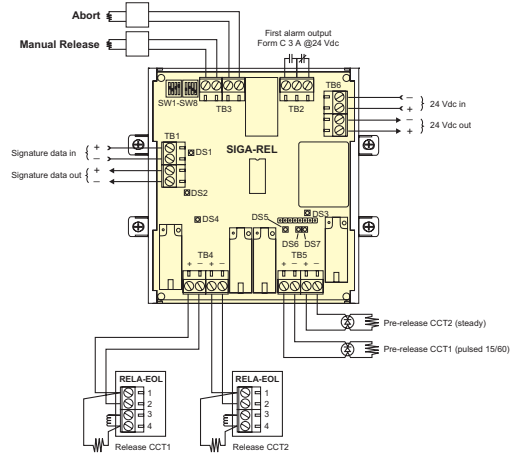

SIGA-REL	Analog addressable releasing module	Data Sheet E85001-0531	<input type="checkbox"/>
RELA-ABT	Abort station	Data Sheet E85001-0531	<input type="checkbox"/>
RELA-SRV	Service disconnect station	Data Sheet E85001-0531	<input type="checkbox"/>
276A-REL	Manual releasing station (single-action)	Data Sheet E85001-0531	<input type="checkbox"/>
278A-REL	Manual releasing station (double-action)	Data Sheet E85001-0531	<input type="checkbox"/>
RELA-EOL	Polarized end-of-line relay	Data Sheet E85001-0531	<input type="checkbox"/>

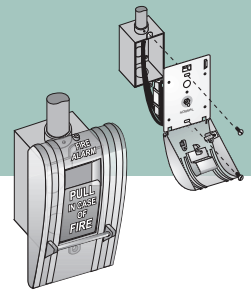

**SUBMIT**



*Signature Series*

## Manual Pull Stations



### Single Action Pull Stations

SIGA-270 series manual pull stations are made from die-cast zinc and finished with red epoxy powder-coat paint. With positive pull-lever operation, one pull on the station handle breaks the rod and turns in a positive alarm. Where two-stage operation is required, SIGA-270P pre-signal models are equipped with a general alarm (GA) keyswitch.

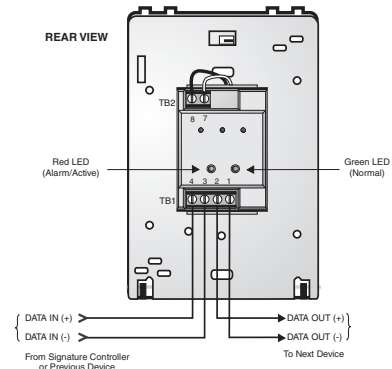

<input type="checkbox"/>	SIGA-270	One Stage Fire Alarm Station, English Markings	Data Sheet E85001-0279
<input type="checkbox"/>	SIGA-270P	Two Stage (Pre-signal) Fire Alarm Station, English Markings	Data Sheet E85001-0279
<input type="checkbox"/>	276-K2	GA Key — for pre-signal station	Data Sheet E85001-0279
<input type="checkbox"/>	270-GLR	20 Break-rods — for SIGA-270 series	Data Sheet E85001-0279
<input type="checkbox"/>	276B-RSB	Surface Mount Box, Red — for SIGA-270 series	Data Sheet E85001-0279



### Double Action Pull Stations

The double action, single stage SIGA-278 station is a contemporary style manual station made from durable red LEXAN. To initiate an alarm, first lift the upper door, then pull the alarm handle.

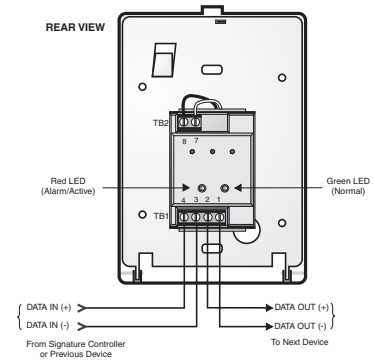

<input type="checkbox"/>	SIGA-278	Double Action (One Stage) Fire Alarm Station, English Markings	Data Sheet E85001-0279
<input type="checkbox"/>	276B-RSB	Surface Mount Box, Red — for SIGA-278 series	Data Sheet E85001-0279
<input type="checkbox"/>	276-GLR	20 Break-rods — for SIGA-278 series	Data Sheet E85001-0279

### Manual Station Relocator

The Manual Station Relocator is designed to lower the height of a fire alarm pull station to meet ADA requirements. Most existing pull stations are mounted 60 inches (1524mm) or higher above the floor. The Relocator lowers the height to 48 inches (1220mm) without the need for pulling new wires or moving the existing electrical box.



<input type="checkbox"/>	RR-32RL	Pull Station Relocator	Data Sheet E85001-0351
--------------------------	---------	------------------------	------------------------



### Stopper II

This unique device helps prevent false alarms without restricting legitimate ones. It consists of a tamper-proof clear LEXAN polycarbonate shield and frame that fits easily over manual pull stations. When lifted, it sounds a piercing warning horn.

<input type="checkbox"/>	<input type="checkbox"/> STI-1100 (Flush)	<input type="checkbox"/> STI-1130 (Surface)	Stopper II with Horn	Data Sheet E85001-0491
<input type="checkbox"/>	<input type="checkbox"/> STI-1200 (Flush)	<input type="checkbox"/> STI-1230 (Surface)	Stopper II without Horn	Data Sheet E85001-0491
<input type="checkbox"/>	<input type="checkbox"/> STI-3100 (2" Spacer)	<input type="checkbox"/> STI-3004 (Conduit Insert)	Spacers	Data Sheet E85001-0491
<input type="checkbox"/>	<input type="checkbox"/> STI-3002 (Gasket)	<input type="checkbox"/> STI-3003 (Conduit Gasket)	Weatherproofing	Data Sheet E85001-0491

# Notification Appliances

- LED Compact Strobes, Horns & Horn-Strobes p.25
- LED Wall Strobes, Horns, Horn-Strobes p.26
- LED Ceiling Strobes, Horns, Horn-Strobes p. 27
- Low Frequency Horns and Horn-Strobes p. 28
- Outdoor Horns & Strobes p. 29
- Wall Speakers & Speaker-Strobes p. 30
- Ceiling Speakers, Horns & Strobes p. 31
- Outdoor Speakers & Strobes p. 32
- Audible Signals p. 33
- Harsh Environment Signals p. 34
- Accessories p. 35
- Audio Notification System p. 36

EDWARDS notification appliances are high-performance devices finely tuned to deliver maximum output in exchange for the lowest possible current draw. Covering the entire spectrum of life safety applications, these devices are durable, dependable, and virtually maintenance-free. And they support a wide range of mounting options that make them ideal for new construction and retrofit applications alike.

### Field Wiring

Notification appliances may be configured for Class A or Class B wiring. Genesis combination horn-strobes, when used with the innovative Signal Master Module, support independent horn control over a single pair of wires and precision synchronization that exceeds UL requirements. This reduces wiring time while meeting the requirements of even the most demanding application.

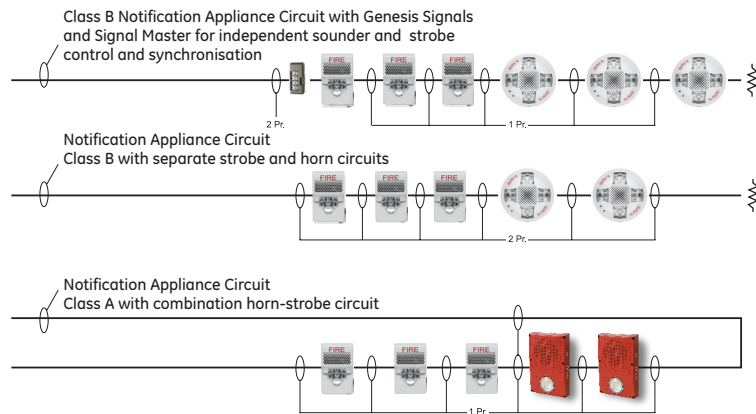

### Device Wiring, Speaker-strobes

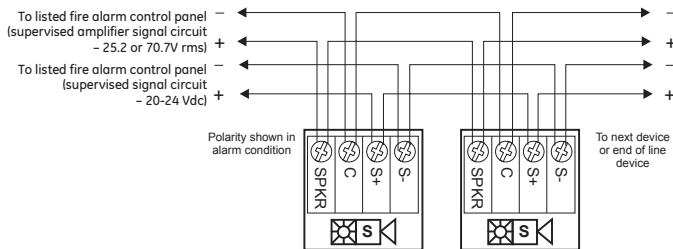

### Strobe Synchronization

On a common circuit, strobes flash once per second (1 fps) within 10 milliseconds over a two-hour time period. A synchronization source is required to comply with UL 1971 synchronization standards. Temporal setting (private mode only): synchronized to temporal output on the same circuit. Genesis LED strobes are synchronized, backwards compatible, and can be used in the same field of view as Genesis xenon strobes.

### Device Wiring, Horn-strobes

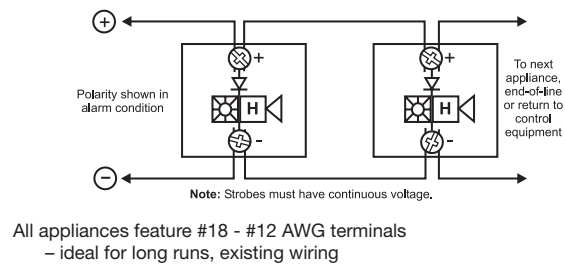

### Synchronization Sources

The following control panels, power supplies, and modules provide synchronization sources that enable Genesis strobe devices to comply with UL 1971 synchronization standards: SIGA-CC1S, SIGA-MCC1S, SIGA-CC2A, SIGA-MCC2A, G1M-RM, BPS6A, BPS10A, APS6A, APS10A, EST3X, iO64, iO Series, Fireshield Plus.

SUBMIT



# Genesis Visual & Audible Signals

A complete line engineered to deliver innovative features and superb output.



LED Compact Strobes, Horns, Horn-Strobes, p. 25



LED Wall Strobes, Horns, Horn-Strobes . p.26



LED Ceiling Strobes, Horns, Horn-Strobes p. 27



Low Frequency Horns and Horn-Strobes, p. 28



Outdoor Horns, Horn-Strobes, p. 29



Wall Speakers and Speaker-strobes, p. 30



Ceiling Speakers, Speaker-strobes, p. 31



Outdoor Speakers, Speaker-Strobes, p. 32

The award-winning Genesis line of products represents excellence in fire alarm notification with looks, features, and performance benefits designed with your project in mind. Wall strobes, horns, and chimes about the size of a deck of playing cards offer a discreet alternative to bulky devices, while speakers and ceiling models with clean modern lines blend inconspicuously with their surroundings.

### Signaling on-demand

Though designed for discretion, Genesis signals are also engineered to command attention. Wall-penetrating high dB output and patented strobe technology immerse the protected area with levels of light and sound that simply can't be ignored – all in exchange for the lowest current demands of any device in their class.

Genesis brings on-demand signaling to every application with an unparalleled range of field-configurable options: horns and chimes with high/low dB output settings; speakers with multiple wattage tap selections; and strobes with selectable candela output and flash rate – options that put you in the driver's seat when time is short, budgets slim, and manpower at a premium. It also means fewer parts to stock, less inventory to worry about, and the flexibility to meet changing demands – on the fly – without having to reinstall equipment or order more parts!

### Application flexibility

Whether you're designing for a new landmark structure, or simply retrofitting a local strip mall, competitively-priced Genesis signals bring value, good looks, and installation flexibility to every application. Contact Edwards today to learn how your signal solutions can be the model of discretion.



### Genesis LED Series Compact Wall Models

# LED Strobes, Horns & Horn-Strobes

Genesis LED G1 Series horns and LED strobes feature a sleek, low-profile design and energy-efficient technology that makes them less expensive to install and operate by reducing overhead. High-performance LEDs and patented electronics allow for more devices per loop and fewer booster power supplies.



**SUBMIT**



**Genesis strobes** offer 15 to 75 candela output, which is selectable with a conveniently located switch on the side of the device. The current is only 24mA VDC and 32mA VFWR for all light output settings. The candela output setting remains clearly visible even after final installation, yet it stays locked in place to prevent unauthorized tampering. (Data Sheet E85001-0667)

White housing ↓ no marking	White housing ↓ with "FIRE"	Red housing ↓ no marking	Red housing ↓ with "FIRE"	White housing ↓ with "ALERT"
<input type="checkbox"/> G1VWN	<input type="checkbox"/> G1VWF	<input type="checkbox"/> G1VRN	<input type="checkbox"/> G1VRF	<input type="checkbox"/> G1VWA



**Genesis Horns** reach output levels as high as 92 dB and feature a unique multiple-frequency tone that results in excellent wall penetration and an unmistakable warning of danger. Horns may be configured for either constant or temporal 3 output and high or low dB output with a conveniently located switch under the cover. No more cutting jumpers. Horns operate at 13mA VDC and 15mA VFWR on Low dB output and 23mA VDC and 29mA VFWR on High dB output. (Data Sheet E85001-0667)

White housing ↓ no marking	White housing ↓ with "FIRE"	Red housing ↓ no marking	Red housing ↓ with "FIRE"
<input type="checkbox"/> G1AWN	<input type="checkbox"/> G1AWF	<input type="checkbox"/> G1ARN	<input type="checkbox"/> G1ARF



**Genesis Horn-strobes** provide a low-profile design with horn output reaching as high as 92 dBA and as low as 80 dBA and have strobes that offer 15 to 75 candela output. Both the horn and strobe can be field configured with a switch, which is conveniently located on the side of the device. The candela output setting remains clearly visible even after final installation, yet it stays locked in place to prevent unauthorized tampering. Horns may be configured for either constant or temporal 3 output and high or low dB output. Horn-Strobes operate at 35mA VDC and 43mA VFWR on Low dB output and 45mA VDC and 55mA VFWR on High dB output for all light output settings. (Data Sheet E85001-0667)

White housing ↓ no marking	White housing ↓ with "FIRE"	Red housing ↓ no marking	Red housing ↓ with "FIRE"
<input type="checkbox"/> G1AVWN	<input type="checkbox"/> G1AVWF	<input type="checkbox"/> G1AVRN	<input type="checkbox"/> G1AVRF



**Trim plates** for wall horns, horn-strobes, and strobes are ideal for covering openings left behind during retrofits.

White plate ↓ no marking	Red plate ↓ no marking	Trim Plates
<input type="checkbox"/> G1TW	<input type="checkbox"/> G1TR	Trim plate for 2-gang or 4" boxes



Replacement covers are available for all models. When ordering add -CVR to the model number.

### Model Number Syntax, Appliances

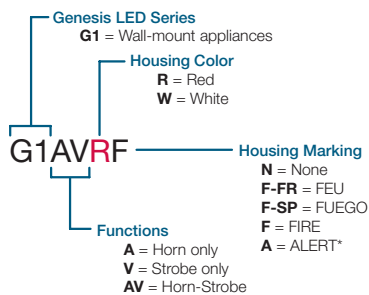

\* ALERT marking available on white strobe model with clear lens only. See replacement covers for more options.

### Model Number Syntax, Replacement Covers

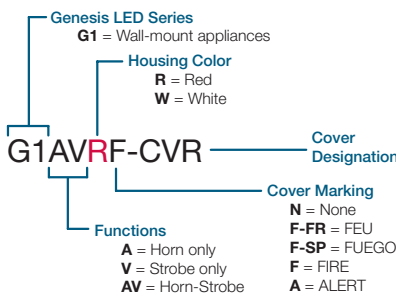

SUBMIT



### Genesis LED Series Wall Models

# LED Strobes, Horns & Horn-Strobes

Genesis LED G4 Series horns and LED strobes feature a sleek, low-profile design and energy-efficient technology that makes them less expensive to install and operate by reducing overhead. High-performance LEDs and patented electronics allow for more devices per loop and fewer booster power supplies. Genesis LED G4 devices mount to the required GP10 room side wiring plate for installation. The GP10 mounting plate is ordered separately from the G4 device in packs of 10 for convenient pre-installing and pre-wiring.



**Genesis strobes** offer 15 to 110 candela output, which is selectable with a conveniently located switch on the side of the device. The current is only 28mA VDC and 36mA VFWR for all light output settings. The candela output setting remains clearly visible even after final installation, yet it stays locked in place to prevent unauthorized tampering. (Data Sheet E85001-0668)

White housing ↓ no marking	White housing ↓ with "FIRE"	Red housing ↓ no marking	Red housing ↓ with "FIRE"	White housing ↓ with "ALERT"
<input type="checkbox"/> G4VWN	<input type="checkbox"/> G4VWF	<input type="checkbox"/> G4VRN	<input type="checkbox"/> G4VRF	<input type="checkbox"/> G4VWA

**Genesis Horns** reach output levels as high as 92 dB and feature a unique multiple-frequency tone that results in excellent wall penetration and an unmistakable warning of danger. Horns may be configured for either constant or temporal 3 output and high or low dB output with a conveniently located switch under the cover. No more cutting jumpers. Horns operate at 18mA VDC and 22mA VFWR on Low dB output and 28mA VDC and 38mA VFWR on High dB output. (Data Sheet E85001-0668)

White housing ↓ no marking	White housing ↓ with "FIRE"	Red housing ↓ no marking	Red housing ↓ with "FIRE"
<input type="checkbox"/> G4AWN	<input type="checkbox"/> G4AWF	<input type="checkbox"/> G4ARN	<input type="checkbox"/> G4ARF

**Genesis Horn-strobes** provide a low-profile design with horn output reaching as high as 92 dBA and as low as 80 dBA and have strobes that offer 15 to 110 candela output. Both the horn and strobe can be field configured with a switch, which is conveniently located on the side of the device. The candela output setting remains clearly visible even after final installation, yet it stays locked in place to prevent unauthorized tampering. Horns may be configured for either constant or temporal 3 output and high or low dB output. Horn-Strobes operate at 40mA VDC and 48mA VFWR on Low dB output and 50mA VDC and 60mA VFWR on High dB output for all light output settings. (Data Sheet E85001-0668)

White housing ↓ no marking	White housing ↓ with "FIRE"	Red housing ↓ no marking	Red housing ↓ with "FIRE"
<input type="checkbox"/> G4AVWN	<input type="checkbox"/> G4AVWF	<input type="checkbox"/> G4AVRN	<input type="checkbox"/> G4AVRF

**Accessories** including required room side wiring plate and trim plates ideal for openings left behind during retrofits.

White plate ↓ no marking	Red plate ↓ no marking	Room Side Wiring Plate ↓ (Required)
<input type="checkbox"/> G4TW	<input type="checkbox"/> G4TR	<input type="checkbox"/> GP10

Replacement covers are available for all models. When ordering add -CVR to the model number.

### Model Number Syntax, Appliances

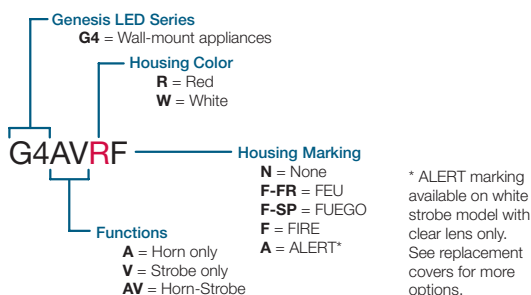

### Model Number Syntax, Replacement Covers

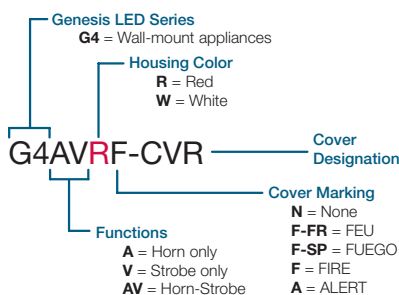

### Genesis LED Series Ceiling Models

# LED Strobes, Horns & Horn-Strobes

Genesis LED GC Series horns and LED strobes feature a sleek, low-profile design and energy-efficient technology that makes them less expensive to install and operate by reducing overhead. High-performance LEDs and patented electronics allow for more devices per loop and fewer booster power supplies. Genesis LED GC devices mount to the required GP10 room side wiring plate for installation. The GP10 mounting plate is ordered separately from the GC device in packs of 10 for convenient pre-installing and pre-wiring.

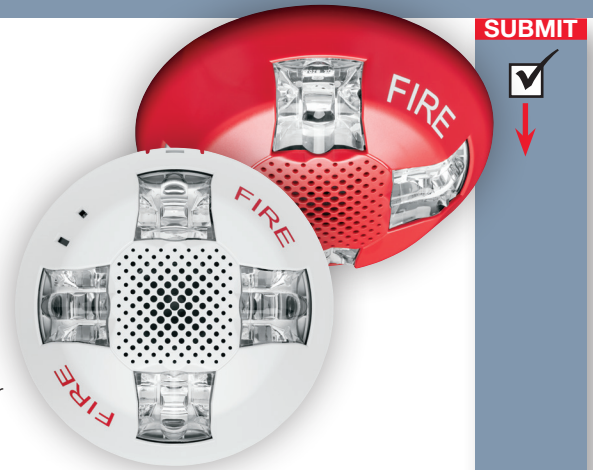

**Genesis strobes** offer 15 to 115 candela output, which is selectable with a conveniently located switch on the side of the device. The current is only 35mA VDC and 45mA VFWR for all light output settings. The candela output setting remains clearly visible even after final installation, yet it stays locked in place to prevent unauthorized tampering. (Data Sheet E85001-1021)

White housing ↓ no marking	White housing ↓ with "FIRE"	Red housing ↓ no marking	Red housing ↓ with "FIRE"
<input type="checkbox"/> GCVWN	<input type="checkbox"/> GCVWF	<input type="checkbox"/> GCVRN	<input type="checkbox"/> GCVRF

**Genesis Horns** reach output levels as high as 92 dB and feature a unique multiple-frequency tone that results in excellent wall penetration and an unmistakable warning of danger. Horns may be configured for either constant or temporal 3 output and high or low dB output with a conveniently located switch under the cover. No more cutting jumpers. Horns operate at 20mA VDC and 25mA VFWR on Low dB output and 30mA VDC and 40mA VFWR on High dB output. (Data Sheet E85001-1021)

White housing ↓ no marking	White housing ↓ with "FIRE"	Red housing ↓ no marking	Red housing ↓ with "FIRE"
<input type="checkbox"/> GCAWN	<input type="checkbox"/> GCAWF	<input type="checkbox"/> GCARN	<input type="checkbox"/> GCARF

**Genesis Horn-strobes** provide a low-profile design with horn output reaching as high as 92 dBA and as low as 80 dBA and have strobes that offer 15 to 115 candela output. Both the horn and strobe can be field configured with a switch, which is conveniently located on the side of the device. The candela output setting remains clearly visible even after final installation, yet it stays locked in place to prevent unauthorized tampering. Horns may be configured for either constant or temporal 3 output and high or low dB output. Horn-Strobes operate at 50mA VDC and 60mA VFWR on Low dB output and 60mA VDC and 75mA VFWR on High dB output for all light output settings. (Data Sheet E85001-1021)

White housing ↓ no marking	White housing ↓ with "FIRE"	Red housing ↓ no marking	Red housing ↓ with "FIRE"
<input type="checkbox"/> GCAVWN	<input type="checkbox"/> GCAVWF	<input type="checkbox"/> GCAVRN	<input type="checkbox"/> GCAVRF

**Accessories** including required room side wiring plate and trim plates ideal for openings left behind during retrofits.

White plate ↓ no marking	Red plate ↓ no marking	Room Side Wiring Plate ↓ (Required)
<input type="checkbox"/> GCTW	<input type="checkbox"/> GCTR	<input type="checkbox"/> GP10

Replacement covers are available for all models. When ordering add -CVR to the model number.

### Model Number Syntax, Appliances

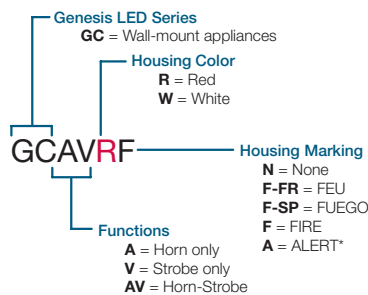

Note: GC devices are designed for ceiling applications but are UL listed to be wall or ceiling mounted.

### Model Number Syntax, Replacement Covers

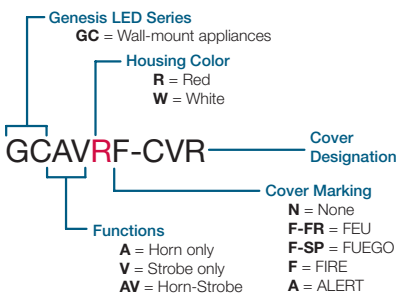

**SUBMIT**



Genesis G4LF Series Wall Models



UL compliant signals for sleeping areas!

## Low Frequency (520 Hz) Horns and Horn-Strobes

G4LF Series notification appliances provide the benefits of Genesis life safety signals with output suitable for sleeping areas and other applications requiring low frequency audible tones. These high-performance appliances generate a crisp 520 Hz tone in the standard 3-3 temporal pattern. An optional setting configures the appliance for continuous audible output — a critical feature for notification appliance circuits that are coded with a CDR-3 coder module. All G4LF appliances feature field-configurable high and low dB output settings. Horn-Strobe models feature field-selectable 15, 30, 75 or 110cd output settings.

<input type="checkbox"/>	G4LFWN-HVM	Horn-Strobe, 520 Hz, White Housing, No Marking, 15/30/75/110 cd	Data Sheet E85001-0639
<input type="checkbox"/>	G4LFWF-HVM	Horn-Strobe, 520 Hz, White Housing, FIRE Marking, 15/30/75/110 cd	Data Sheet E85001-0639
<input type="checkbox"/>	G4LFRN-HVM	Horn-Strobe, 520 Hz, Red Housing, No Marking, 15/30/75/110 cd	Data Sheet E85001-0639
<input type="checkbox"/>	G4LFRF-HVM	Horn-Strobe, 520 Hz, Red Housing, FIRE Marking, 15/30/75/110 cd	Data Sheet E85001-0639
<input type="checkbox"/>	G4LFWN-H	Horn, 520 Hz, White Housing, No Marking	Data Sheet E85001-0639
<input type="checkbox"/>	G4LFWF-H	Horn, 520 Hz, White Housing, FIRE Marking	Data Sheet E85001-0639
<input type="checkbox"/>	G4LFRN-H	Horn, 520 Hz, Red Housing, No Marking	Data Sheet E85001-0639
<input type="checkbox"/>	G4LFRF-H	Horn, 520 Hz, Red Housing, FIRE Marking	Data Sheet E85001-0639

Genesis WG4 Series Wall Models

## Weatherproof Horns and Horn-Strobes

Genesis WG4 Series horns and horn-strobes are among the most versatile emergency signals of their kind. Rated for indoor or outdoor use, they are suitable for a wide range of wet and harsh environments with a listed operating temperature range of as low as -31°F to as high as 151°F (-35°C to 66°C).

Refer to Data Sheet E85001-0628 -- Genesis Outdoor Horns and Strobes for details.



SUBMIT



### Field Configuration

Genesis WG4 strobes feature four selectable light output settings. Cd selections are changed by removing the cover and simply sliding the switches to the desired setting, which remains visible through a small window on the front of the device after the cover is replaced. Genesis Horn-strobes may also be configured for high or low dB output and temporal flash. This battery-saving feature is intended for private mode signaling only.

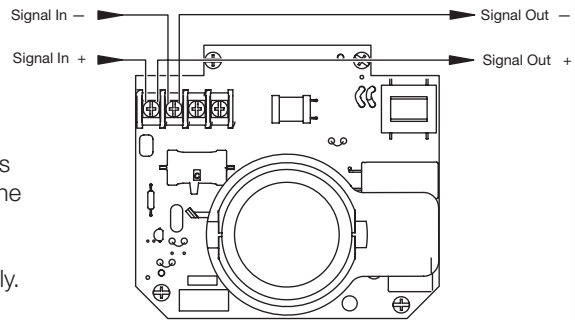

-/+ designations indicate the signal polarity required to activate the device.



### Light Output

#### Standard Candela Horn-strobes

Standard/rating	Strobe Switch Position			
	D	C	B	A
UL 1971 Indoor	15 cd	29 cd	70 cd	87 cd
UL 1638 Outdoor @ -35°C	6 cd	12 cd	28 cd	35 cd
CAN/ULC-S526 Outdoor @ -40°C	1 cd	3 cd	8 cd	10 cd

#### High Candela Horn-strobes

Standard/rating	Strobe Switch Position			
	D	C	B	A
UL 1971 Indoor	102cd	123cd	147cd	161cd
UL 1638 Outdoor @ -35°C	41cd	50 cd	60 cd	65 cd
CAN/ULC-S526 Outdoor @ -40°C	11 cd	14 cd	17 cd	18 cd

White housing ↓ no marking	White housing ↓ with "FIRE"	Red housing ↓ no marking	Red housing ↓ with "FIRE"	Outdoor Fire Alarm Appliances
<input type="checkbox"/> WG4WN-H	<input type="checkbox"/> WG4WF-H	<input type="checkbox"/> WG4RN-H	<input type="checkbox"/> WG4RF-H	Horn Only
<input type="checkbox"/> WG4WN-HVMC	<input type="checkbox"/> WG4WF-HVMC	<input type="checkbox"/> WG4RN-HVMC	<input type="checkbox"/> WG4RF-HVMC	Horn-Strobe, standard cd output
<input type="checkbox"/> WG4WN-HVMHC	<input type="checkbox"/> WG4WF-HVMHC	<input type="checkbox"/> WG4RN-HVMHC	<input type="checkbox"/> WG4RF-HVMHC	Horn Only, high cd output

### WG4 Mounting Accessories

<input type="checkbox"/> WG4WTS (white)	<input type="checkbox"/> WG4RTS (red)	Surface Skirt for Genesis WG4 Appliances
<input type="checkbox"/> 74347U (white)	<input type="checkbox"/> 449 (red)	Surface mount box, outdoor rated
<input type="checkbox"/> WG4GSKT		Genesis WG4 Full Body Mounting Gasket for Smooth Surfaces

For Audible Sounder Bases, see *Intelligent Initiating Devices*.



Candela and wattage settings remain clearly visible even after final installation.

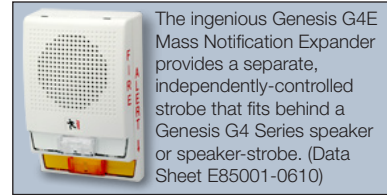

The ingenious Genesis G4E Mass Notification Expander provides a separate, independently-controlled strobe that fits behind a Genesis G4 Series speaker or speaker-strobe. (Data Sheet E85001-0610)

### Genesis G4 Series Wall Models

# Speakers and Speaker-strobes

**Genesis speakers** combine high performance output with a low profile design to deliver a life safety audio solution that's as versatile as it is effective. Protruding no more than one inch from the wall, these appliances blend inconspicuously with any decor. All speakers feature selectable ¼, ½, 1, or 2 watt operation.

**Speaker-strobes** feature field-configurable candela output, selectable with a conveniently-located switch on the bottom of the device.

*Genesis high fidelity Speakers are can generate UL compliant low frequency signals now required for sleeping areas!*

**High fidelity speakers and speaker-strobes** meet new standards for audible tones in sleeping areas and produce crisp, clear voice audio output that is highly intelligible over large areas. (Data Sheet E85001-0642)

	White housing ↓ no marking	White housing ↓ with "FIRE"	Red housing ↓ no marking	Red housing ↓ with "FIRE"	Fire Alarm Speakers (no "Running Man" icon)
<input type="checkbox"/>	<input type="checkbox"/> G4HFN-S2	<input type="checkbox"/> G4HFWF-S2	<input type="checkbox"/> G4HFRN-S2	<input type="checkbox"/> G4HFRF-S2	25 V Speaker
<input type="checkbox"/>	<input type="checkbox"/> G4HFN-S7	<input type="checkbox"/> G4HFWF-S7	<input type="checkbox"/> G4HFRN-S7	<input type="checkbox"/> G4HFRF-S7	70 V Speaker
<input type="checkbox"/>	<input type="checkbox"/> G4HFN-S2VM	<input type="checkbox"/> G4HFWF-S2VM	<input type="checkbox"/> G4HFRN-S2VM	<input type="checkbox"/> G4HFRF-S2VM	25 V Speaker-strobe (15/30/75/110 cd settings)
<input type="checkbox"/>	<input type="checkbox"/> G4HFN-S7VM	<input type="checkbox"/> G4HFWF-S7VM	<input type="checkbox"/> G4HFRN-S7VM	<input type="checkbox"/> G4HFRF-S7VM	70 V Speaker-strobe (15/30/75/110 cd settings)

**High fidelity mass notification speakers and speaker-strobes** feature optional amber lenses and "ALERT" lettering on white housings, and meet new standards for audible tones in sleeping areas. (Data Sheet E85001-0642)

	Clear lens ↓ "ALERT"	Amber lens ↓ no marking	Amber lens ↓ "ALERT"	High Fidelity Mass Notification Speakers – white housing, no "Running Man" icon
<input type="checkbox"/>	<input type="checkbox"/> G4HFWA-S2VMC	<input type="checkbox"/> G4HFWN-S2VMA	<input type="checkbox"/> G4HFWA-S2VMA	25 V Speaker-strobe (A/B/C/D cd settings)
<input type="checkbox"/>	<input type="checkbox"/> G4HFWA-S7VMC	<input type="checkbox"/> G4HFWN-S7VMA	<input type="checkbox"/> G4HFWA-S7VMA	70 V Speaker-strobe (A/B/C/D cd settings)
<input type="checkbox"/>	Speaker only models:		<input type="checkbox"/> G4HFWA-S2 (25 V, "ALERT" marking)	<input type="checkbox"/> G4HFWA-S7 (70 V, "ALERT" marking)

SUBMIT



Genesis GC Series Ceiling Models

## Speakers and Speaker-Strobes

The Genesis line of multi-candela and multi-wattage ceiling signals feature all the hallmarks that have made Genesis products a big hit with designers, engineers, building owners, and installers everywhere. Precision timing electronics, and low current draw bring the benefits of the popular Genesis wall-mount models to ceiling applications. These signals are 30 percent slimmer than comparable signals on the market. They are compatible with standard 4-inch (10 cm) square electrical boxes and don't require extension rings or trim plates.



Select 15/30/75/95 and 95/115/150/177 candela output!

Select ¼, ½, 1, or 2 watt operation!

Data Sheet E85001-0641

### High Fidelity Fire Alarm Speakers and Speaker-Strobes

White housing ↓ no marking	White housing ↓ with "FIRE"	Red housing ↓ no marking	Red housing ↓ with "FIRE"	All fire alarm appliances come with the "Running Man" Icon	
<input type="checkbox"/> GCHFVN-S2VMC	<input type="checkbox"/> GCHFVF-S2VMC	<input type="checkbox"/> GCHFVN-S2VMC	<input type="checkbox"/> GCHFVF-S2VMC	25 V Spkr + 15/30/75/110 cd strobe	<input type="checkbox"/>
<input type="checkbox"/> GCHFVN-S2VMCH	<input type="checkbox"/> GCHFVF-S2VMCH	<input type="checkbox"/> GCHFVN-S2VMCH	<input type="checkbox"/> GCHFVF-S2VMCH	25 V Spkr + 95/115/150/177 cd strobe	<input type="checkbox"/>
<input type="checkbox"/> GCHFVN-S7VMC	<input type="checkbox"/> GCHFVF-S7VMC	<input type="checkbox"/> GCHFVN-S7VMC	<input type="checkbox"/> GCHFVF-S7VMC	70 V Spkr + 15/30/75/110 cd strobe	<input type="checkbox"/>
<input type="checkbox"/> GCHFVN-S7VMCH	<input type="checkbox"/> GCHFVF-S7VMCH	<input type="checkbox"/> GCHFVN-S7VMCH	<input type="checkbox"/> GCHFVF-S7VMCH	70 V Spkr + 95/115/150/177 cd strobe	<input type="checkbox"/>
<input type="checkbox"/> GCHFVN-S2	<input type="checkbox"/> GCHFVF-S2	<input type="checkbox"/> GCHFVN-S2	<input type="checkbox"/> GCHFVF-S2	Speaker-only models, 25 V	<input type="checkbox"/>
<input type="checkbox"/> GCHFVN-S7	<input type="checkbox"/> GCHFVF-S7	<input type="checkbox"/> GCHFVN-S7	<input type="checkbox"/> GCHFVF-S7	Speaker-only models, 70 V	<input type="checkbox"/>

### High Fidelity Mass Notification Speakers and Speaker-strobes

Clear lens ↓ with "ALERT"	Amber lens ↓ no marking	Amber lens ↓ with "ALERT"	White housings No "Running Man" Icon		
<input type="checkbox"/> GCHFVA-S2VMC	<input type="checkbox"/> GCHFVN-S2VMA	<input type="checkbox"/> GCHFVA-S2VMA	25 V Speaker, four standard cd settings	<input type="checkbox"/>	
<input type="checkbox"/> GCHFVA-S2VMCH	<input type="checkbox"/> GCHFVN-S2VMAH	<input type="checkbox"/> GCHFVA-S2VMAH	25 V Speaker, four high cd settings	<input type="checkbox"/>	
<input type="checkbox"/> GCHFVA-S7VMC	<input type="checkbox"/> GCHFVN-S7VMA	<input type="checkbox"/> GCHFVA-S7VMA	70 V Speaker, four standard cd settings	<input type="checkbox"/>	
<input type="checkbox"/> GCHFVA-S7VMCH	<input type="checkbox"/> GCHFVN-S7VMAH	<input type="checkbox"/> GCHFVA-S7VMAH	70 V Speaker, four high cd settings	<input type="checkbox"/>	
<input type="checkbox"/> GCHFVA-S2 (25 V, "ALERT" marking)		<input type="checkbox"/> GCHFVA-S7 (70 V, "ALERT" marking)		Speaker-only models	<input type="checkbox"/>

SUBM



### Genesis WG4 Series Wall Models

# Weatherproof Speakers and Speaker-Strobes

Genesis WG4 Series speakers and speaker-strobes are among the most versatile emergency signals of their kind. Rated for indoor or outdoor use, they are suitable for a wide range of wet and harsh environments with a listed operating temperature range of as low as -31°F to as high as 151°F (-35°C to 66°C).

Refer to Data Sheet E85001-0626 -- Genesis Outdoor Speakers and Strobes for details.

### Field Configuration

Genesis WG4 speakers may be set 70- or 25-Volt operation, and for ¼, ½, 1, or 2 watt operation. Strobe models feature four selectable light output settings. Wattage and cd selections are changed by removing the cover and simply sliding the switches to the desired settings, which remain visible through a small window on the front of the device after the cover is replaced. Genesis speaker-strobes may also be configured for temporal flash. This battery-saving feature is intended for private mode signaling only. To set the device for temporal flash, snip the jumper at JP1.

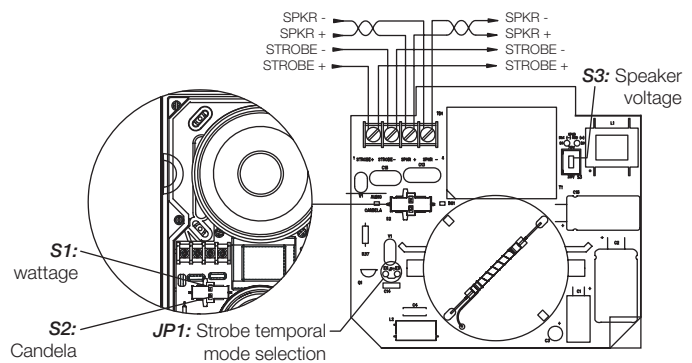

White housing ↓ no marking	White housing ↓ with "FIRE"	Red housing ↓ no marking	Red housing ↓ with "FIRE"	Fire Alarm Speakers
<input type="checkbox"/> WG4WN-S	<input type="checkbox"/> WG4WF-S	<input type="checkbox"/> WG4RN-S	<input type="checkbox"/> WG4RF-S	25/70 V Speaker
<input type="checkbox"/> WG4WN-SVMC	<input type="checkbox"/> WG4WF-SVMC	<input type="checkbox"/> WG4RN-SVMC	<input type="checkbox"/> WG4RF-SVMC	25/70 V Speaker-strobe (15/29/70/87 cd)
<input type="checkbox"/>	<input type="checkbox"/> WG4WF-SVMHC	<input type="checkbox"/> WG4RN-SVMHC	<input type="checkbox"/> WG4RF-SVMHC	25/70 V Speaker-strobe (102/123/147/161 cd)

**Genesis mass notification speakers and speaker-strobes** bring the same high-performance fire alarm features and unobtrusive design to mass notification applications. Available with amber lenses and optional "ALERT" lettering, they are ideal for applications that require differentiation between fire alarm and mass notification alerts.

White housing ↓ no marking	White housing ↓ "ALERT"	Mass Notification Speakers – white housing, no "Running Man" icon
<input type="checkbox"/> WG4WN-SVMA	<input type="checkbox"/> WG4WA-SVMA	25/70 V Speaker-strobe, amber lens (13/25/5962 cd output)
<input type="checkbox"/> WG4WN-SVMHA	<input type="checkbox"/> WG4WA-SVMHA	25/70 V Speaker-strobe, amber lens (84/101/125/130 cd output)
<input type="checkbox"/>	<input type="checkbox"/> WG4WA-SVMC	25/70 V Speaker-strobe, clear lens (15/29/70/87 cd output)
<input type="checkbox"/> WG4WN-SVMHC	<input type="checkbox"/> WG4WA-SVMHC	25/70 V Speaker-strobe, clear lens (102/123/147/161 cd output)
<input type="checkbox"/>	<input type="checkbox"/> WG4WA-S	25/70 V Speaker

### Trim skirts

<input type="checkbox"/> WG4WTS (white)	<input type="checkbox"/> WG4RTS (red)	Surface Skirt for Genesis WG4 appliance family.
---	---------------------------------------	---



Genesis GL Series Wall Models

## Audible Signals



### Fire Alarm Bells

Edwards fire alarm bells are of the underdome type with heavy-duty mechanisms. Gongs are made of selected alloy steel to generate the loud, resonant tones. For weatherproof application, optional surface weatherproof backboxes are available.

<input type="checkbox"/> 323D-10AW (Grey)	<input type="checkbox"/> 323D-10AW-R (Red)	10-inch Single Stroke, Diode — 20-24Vdc	Data Sheet E85001-0333	<input type="checkbox"/>
<input type="checkbox"/> 439D-6AW (Grey)	<input type="checkbox"/> 439D-6AW-R (Red)	6-inch Vibrating, Diode — 20-24Vdc	Data Sheet E85001-0333	<input type="checkbox"/>
<input type="checkbox"/> 439D-10AW (Grey)	<input type="checkbox"/> 439D-10AW-R (Red)	10-inch Vibrating, Diode — 20-24Vdc	Data Sheet E85001-0333	<input type="checkbox"/>



### Multiple Tone Signal

The 5530MD-24AW is a weatherproof heavy-duty industrial, tone-selectable, signaling device capable of producing volume-controlled, high-decibel tones. It uses a microprocessor circuit to create 27 distinctive tones. A single tone may be selected by setting a miniature dip switch within the unit.

5530MD-24AW	27-Tone Selectable Signal — 24Vdc	Data Sheet E85001-0415	<input type="checkbox"/>
-------------	-----------------------------------	------------------------	--------------------------



### Multi-purpose Loudspeaker

The HPSA15 loudspeaker is a high-efficiency double re-entrant loudspeaker that operates within a nominal frequency response range of 400-14,000 Hz, and provides audible output of 120 dB (peak at one meter) at the rated power level. It includes a versatile, three-way, 25/70.7 V line transformer that meets a variety of distributed system needs. The transformer is adjustable by means of a convenient seven-position, watts/impedance selection switch.

HPSA15R2570	15-watt loudspeaker, red	Data Sheet E85001-0591	<input type="checkbox"/>
HPSA15G2570	15-watt loudspeaker, gray	Data Sheet E85001-0591	<input type="checkbox"/>

## Medium Power Speaker Arrays



The EDWARDS HyperSpike® Series TCPA-10 is intended for indoor and outdoor audio signaling and notification. Its best-in-class acoustic coverage allows for fewer units to be installed in large indoor and outdoor areas, lowering installation and long-term maintenance costs, while also improving intelligibility and aesthetics.

↓	↓ Color:	MPSA Assemblies		
<input type="checkbox"/> 90215A-801-01-L	<input type="checkbox"/> Black	UL 1480 listed C1D2 certified TCPA-10 Distributed Audio Speaker with 5 selectable power taps that run off of 25V, 70V and 100 VRMS audio systems	Data Sheet E85001-0669	<input type="checkbox"/>
<input type="checkbox"/> 90215A-801-04-L	<input type="checkbox"/> Gray	UL 1480 listed C1D2 certified TCPA-10 Distributed Audio Speaker with 5 selectable power taps that run off of 25V, 70V and 100 VRMS audio systems	Data Sheet E85001-0669	<input type="checkbox"/>
<input type="checkbox"/> 90215A-801-05-L	<input type="checkbox"/> Red	UL 1480 listed C1D2 certified TCPA-10 Distributed Audio Speaker with 5 selectable power taps that run off of 25V, 70V and 100 VRMS audio systems	Data Sheet E85001-0669	<input type="checkbox"/>
<input type="checkbox"/> 90215A-801-06-L	<input type="checkbox"/> White	UL 1480 listed C1D2 certified TCPA-10 Distributed Audio Speaker with 5 selectable power taps that run off of 25V, 70V and 100 VRMS audio systems	Data Sheet E85001-0669	<input type="checkbox"/>

**SUBMIT**



### Enhanced Integrity Series

# Harsh Environment Signals

All Enhanced Integrity devices are UL 1971 listed for both wall and ceiling orientation. Enhanced Integrity strobes meet the latest UL1971 synchronization requirements when used with the G1M Signal Master. Integrity devices are shipped with wall mount style "FIRE" lens markings. Other lens markings are available.

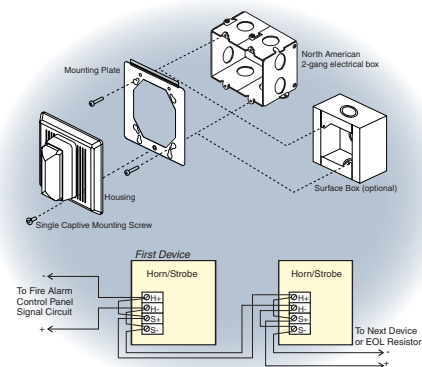

### Re-Entrant Speakers and Speaker-Strobes

Re-entrant speakers feature a sealed, high efficiency compression driver that's both weatherproof and vermin proof. This makes them ideal for public places and outdoor areas such as parking garages and transport terminals. All Integrity speakers include a DC Blocking Capacitor that permits electrical supervision of the audio distribution circuit. Models for 25V<sub>RMS</sub> and 70V<sub>RMS</sub> circuits are available.

#### Fire Alarm Appliances, clear lenses, Data Sheet E85001-0317

	↓ 15/75 cd	↓ 30 cd	↓ 110 cd	↓ Speaker only	
<input type="checkbox"/>	<input type="checkbox"/> 757-7A-RS25	<input type="checkbox"/> 757-3A-RS25	<input type="checkbox"/> 757-8A-RS25	<input type="checkbox"/> 757-1A-R25	Speaker-strobe, 25 V, red housing
<input type="checkbox"/>	<input type="checkbox"/> 757-7A-RS25W	<input type="checkbox"/> 757-3A-RS25W	<input type="checkbox"/> 757-8A-RS25W	<input type="checkbox"/> 757-1A-R25W	Speaker-strobe, 25 V, white housing
<input type="checkbox"/>	<input type="checkbox"/> 757-7A-RS70	<input type="checkbox"/> 757-3A-RS70	<input type="checkbox"/> 757-8A-RS70	<input type="checkbox"/> 757-1A-R70	Speaker-strobe, 70 V, red housing
<input type="checkbox"/>	<input type="checkbox"/> 757-7A-RS70W	<input type="checkbox"/> 757-3A-RS70W	<input type="checkbox"/> 757-8A-RS70W	<input type="checkbox"/> 757-1A-R70W	Speaker-strobe, 70 V, white housing

#### ECS/MNS Appliances, amber lenses, Data Sheet E85001-0317

<input type="checkbox"/>	<input type="checkbox"/> 757-7A-RS25WA (12/75 cd)	<input type="checkbox"/> 757-8A-RS25WA (88 cd)	Speaker-strobe, 25 V, white housing
<input type="checkbox"/>	<input type="checkbox"/> 757-7A-RS70WA (12/75 cd)	<input type="checkbox"/> 757-8A-RS70WA (88 cd)	Speaker-strobe, 70 V, white housing



### Temporal Horns and Horn-Strobes

During installation, the Horn is configured for steady or temporal tone signal. When temporal output is selected, all Horns on a common two-wire circuit are self-synchronized. Integrity Series Horns emit a low frequency "growling" tone that demands attention. Horns can be configured for either high output (98 dBA) or low output (94 dBA); and are listed for outdoor use.

<input type="checkbox"/>	<input type="checkbox"/> 757-1A-T (Red)	<input type="checkbox"/> 757-1A-TW (White)	Temporal Horn	Data Sheet E85001-0341
<input type="checkbox"/>	<input type="checkbox"/> 757-7A-T (Red)	<input type="checkbox"/> 757-7A-TW (White)	Temporal Horn-Strobe, 15/75cd	Data Sheet E85001-0341
<input type="checkbox"/>	<input type="checkbox"/> 757-4A-T (Red)	<input type="checkbox"/> 757-4A-TW (White)	Temporal Horn-Strobe, 75cd	Data Sheet E85001-0341
<input type="checkbox"/>	<input type="checkbox"/> 757-8A-T (Red)	<input type="checkbox"/> 757-8A-TW (White)	Temporal Horn-Strobe, 110cd	Data Sheet E85001-0341



### 4" Square Box Mount Strobes

405 Series strobes are self-synchronized to flash at one fps across their full operating voltage range. UL 1971 synchronization requirements are achieved when used with the G1M Signal Master. Strobes must be connected to signal circuits that output a constant (not pulsed) voltage. A diode is used to allow full signal circuit supervision. 405 Series strobes are suitable for outdoor use and installed to a standard four-inch square electrical box.

<input type="checkbox"/>	<input type="checkbox"/> 405-5A-T (Red)	<input type="checkbox"/> 405-5A-TW (White)	Strobe - 15 cd	Data Sheet E85001-0305
<input type="checkbox"/>	<input type="checkbox"/> 405-7A-T (Red)	<input type="checkbox"/> 405-7A-TW (White)	Strobe - 15/75	Data Sheet E85001-0305
<input type="checkbox"/>	<input type="checkbox"/> 405-3A-T (Red)	<input type="checkbox"/> 405-3A-TW (White)	Strobe - 30 cd	Data Sheet E85001-0305
<input type="checkbox"/>	<input type="checkbox"/> 405-6A-T (Red)	<input type="checkbox"/> 405-6A-TW (White)	Strobe - 60 cd	Data Sheet E85001-0305
<input type="checkbox"/>	<input type="checkbox"/> 405-8A-T (Red)	<input type="checkbox"/> 405-8A-TW (White)	Strobe - 110 cd	Data Sheet E85001-0305
<input type="checkbox"/>	<input type="checkbox"/> CS-405-7A-T (15/75 cd)	<input type="checkbox"/> CS-405-8A-T (110 cd)	Strobe - Weatherproof (red)	Data Sheet E85001-0305

**SUBMIT**



## Accessories



### Bell/Strobe Plate

The bell/strobe plate is ideal for renovation and retrofit projects, and new construction. It is equipped with an Edwards self-synchronizing strobe and is designed to allow on-site mounting of the 439 series Vibrating Bell, providing instant conversion to Bell/Strobe audible/visual signal appliances. The strobe is designed for 20 to 24Vdc operation and must be connected to signal circuits which output a constant (not pulsed) voltage. A diode is used to allow full signal circuit supervision.

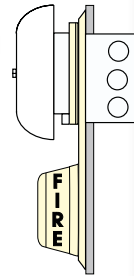

- 403-5A-R (15 cd)  403-7A-R (15/75 cd)  403-3A-R (30 cd)  403-8A-R (110 cd)

Data Sheet E85001-0441

### Genesis Signal Master

The Signal Master adds enhanced features to Genesis and Integrity strobes and Horn-Strobes. It is a dual-purpose module that provides UL 1971 required precision synchronization for connected Integrity and Genesis strobes, and independent control for connected Genesis Horns over a single pair of wires.



Snap-on (piggyback) model



Remote 1-gang mount model

- G1M Genesis Signal Master – Snap-on (piggyback)

Data Sheet E85001-0545

- G1M-RM Genesis Signal Master – Remote 1-Gang Mount

Data Sheet E85001-0545

### Integrity Lens Marking Kits

Integrity strobes are shipped with wall mount style “FIRE” lens markings. Where ceiling mount, other languages or different lens markings are required, optional LKW and LKC series Lens Marking Kits are available. Lens marking sleeves snap right over the strobe lens providing a quick, easy, change.



- |  |   |                          |
|--|---|--------------------------|
| <input type="checkbox"/> LKW-1R (Wall orientation) | “FIRE” (Red)  | <input type="checkbox"/> |
| <input type="checkbox"/> LKW-1 (Wall orientation)  | <input type="checkbox"/> LKC-1 (Ceiling orientation)  | “FIRE”                   |
| <input type="checkbox"/> LKW-2 (Wall orientation)  | <input type="checkbox"/> LKC-2 (Ceiling orientation)  | “FEU”                    |
| <input type="checkbox"/> LKW-3 (Wall orientation)  | <input type="checkbox"/> LKC-3 (Ceiling orientation)  | “FIRE/FEU”               |
| <input type="checkbox"/> LKW-4 (Wall orientation)  | <input type="checkbox"/> LKC-4 (Ceiling orientation)  | “SMOKE”                  |
| <input type="checkbox"/> LKW-5 (Wall orientation)  | <input type="checkbox"/> LKC-5 (Ceiling orientation)  | “HALON”                  |
| <input type="checkbox"/> LKW-6 (Wall orientation)  | <input type="checkbox"/> LKC-6 (Ceiling orientation)  | “CO2”                    |
| <input type="checkbox"/> LKW-7 (Wall orientation)  | <input type="checkbox"/> LKC-7 (Ceiling orientation)  | “EMERGENCY”              |
| <input type="checkbox"/> LKW-8 (Wall orientation)  | <input type="checkbox"/> LKC-8 (Ceiling orientation)  | “ALARM”                  |
| <input type="checkbox"/> LKW-9 (Wall orientation)  | <input type="checkbox"/> LKC-9 (Ceiling orientation)  | “FUEGO”                  |
| <input type="checkbox"/> LKW-10 (Wall orientation) | <input type="checkbox"/> LKC-10 (Ceiling orientation) | “ALERT”                  |

### Mounting Accessories

- Integrity Temporal Horn, Horn/strobe**
- 757A-SB Surface Box, Red, Indoor
  - 757A-SBW Surface Box, White, Indoor
  - 757A-WB Weatherproof Box, Red, Surface
  - 757A-WBW Weatherproof Box, White, Surface

- Integrity Speakers, Speaker/strobes**
- 960A-4SF Flush Box, Indoor
  - 757A-SB Surface Box, Red, Indoor
  - 757A-SBW Surface Box, White, Indoor

- Integrity Re-entrant speakers, Speaker/strobes**
- 960A-4SF Flush Box, Indoor
  - 757A-SB Surface Box, Red, Indoor
  - 757A-SBW Surface Box, White, Indoor
  - 757A-WB Weatherproof Box, Red, Surface
  - 757A-WBW Weatherproof Box, White, Surface

- Integrity Chimes, Chime/strobes**
- 757A-SB Surface Box, Red, Indoor
  - 757A-SBW Surface Box, White, Indoor

- Genesis Signals**
- 27193-11 Horn-strobe Surface Box, Red, Indoor
  - 27193-16 Horn-strobe Surface Box, White, Indoor
  - G4RB Speaker Surface Box, Red, Indoor
  - G4B Speaker Surface Box, White, Indoor
  - G4ERB G4 Dual-strobe Format Surface box, Red
  - G4EWB G4 Dual-strobe Format Surface box, White

- Horn/siren Combination**
- 349 Weatherproof Backbox

- Fire Alarm Bells and CS-405 Series**
- 449 Weatherproof Backbox

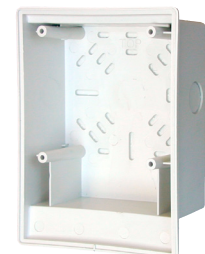

Genesis G4B Speaker Surface Box

Notification Appliances

Hazardous Location Devices

Door Holders & Relays

SUBMIT



# Audio Notification System

See Data Sheet E85001-0587 for complete specifications and ordering information.

The ANS series is a collection of high-performance audio notification systems that provide voice evacuation capability which meets the emergency voice alarm requirements of NFPA 72 for UL listed fire alarm applications. ANS panels are available in 25, 50, or 100 Watt models and include a microphone, amplifier, tone generator, digital message repeater (DMR), and supervisory interface. Additionally, the 25 and 100Watt amplifiers are 520 Hz compliant.

These self-contained systems offer robust field-configurable features and are supported by a wide range of accessory equipment that provides application flexibility and reliable performance for new and retrofit installations alike. Expander panels and modules extend the range of the ANS system to meet the needs of demanding audio applications. Accessory equipment such as zone switchers and remote microphones offer the sophistication of high-end systems for a relatively low cost..

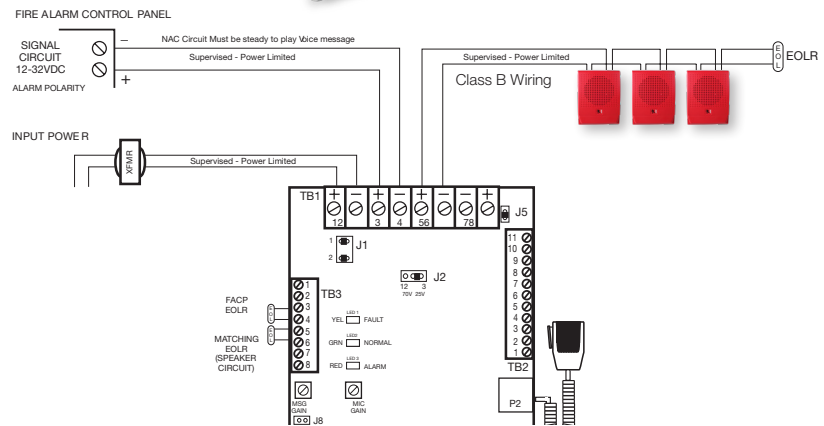

### Audio Notification Panels

Panels include DMR, Power Supply & Battery Charger, Standard Message, Microphone, and Cabinet.

<input type="checkbox"/>	<input type="checkbox"/> ANS25MDG2 (Grey Cabinet)	<input type="checkbox"/> ANS25MDG2 (Red Cabinet)	25 Watt Audio Notification Panel.
<input type="checkbox"/>	<input type="checkbox"/> ANS50MDG2 (Grey Cabinet)	<input type="checkbox"/> ANS50MDG2 (Red Cabinet)	50 Watt Audio Notification Panel.
<input type="checkbox"/>	<input type="checkbox"/> ANS100MDG2 (Grey Cabinet)	<input type="checkbox"/> ANS100MDG2 (Red Cabinet)	100 Watt Audio Notification Panel.

### Audio Expander Panels

<input type="checkbox"/>	<input type="checkbox"/> ANS25XG (Grey Cabinet)	<input type="checkbox"/> ANS25XR (Red Cabinet)	25 Watt Audio Expander Panel.
<input type="checkbox"/>	<input type="checkbox"/> ANS50XG (Grey Cabinet)	<input type="checkbox"/> ANS50XR (Red Cabinet)	50 Watt Audio Expander Panel.
<input type="checkbox"/>	<input type="checkbox"/> ANS100XG (Grey Cabinet)	<input type="checkbox"/> ANS100XR (Red Cabinet)	100 Watt Audio Expander Panel.

### Audio Notification System Accessories

<input type="checkbox"/>	ANSZM4B2A	Zone Module. 4 Class B or 2 Class A circuits.
<input type="checkbox"/>	ANSREMG	Remote microphone. Requires ANSREMSUP card in ANS panel. Gray cabinet. Supervised.
<input type="checkbox"/>	ANSREMR	Remote microphone. Requires ANSREMSUP card in ANS panel. Red cabinet. Supervised.
<input type="checkbox"/>	ANSREMSUP	Remote microphone supervisory card, one per system. Supervises up to 5 remote microphones.
<input type="checkbox"/>	ANSBKUP	Backup amplifier switching module.
<input type="checkbox"/>	ANS100A	100 Watt expander module.
<input type="checkbox"/>	ANS100AMD2	100 Watt audio notification module with DMR and microphone.
<input type="checkbox"/>	ANS25A	25 Watt expander module.
<input type="checkbox"/>	ANS25AMD2	25 Watt audio notification module with DMR and microphone.
<input type="checkbox"/>	ANS50A	50 Watt expander module.
<input type="checkbox"/>	ANS50AMD2	50 Watt audio notification module with DMR and microphone.
<input type="checkbox"/>	ANSDC8	8 dry-contact input/LED module.
<input type="checkbox"/>	ANSSW8	8 position switch/LED module.
<input type="checkbox"/>	ANSXM8	8 transistor output/LED module.
<input type="checkbox"/>	ANSDMRALT	Alternate prerecorded DMR message PROM from library.
<input type="checkbox"/>	ANSCONFSOFT1	ANS Configuration Software.

# Hazardous Location Devices

Edwards hazardous location devices provide reliable life safety protection and emergency signaling in areas where atmospheres could become harsh or explosive. All hazardous location devices are UL rated under the full range of classifications set out in the National Electrical Code.

The following classification definitions are an interpretive summary based on the 1996 edition of the National Electrical Code (NEC, NFPA 70). Refer to the latest editions of NFPA 497M, NFPA 70 and the UL Hazardous Location Equipment Directory for current and more detailed information. For more information on NEMA classifications, refer to NEMA Standards Publication No. 250.

## Hazardous Location Classifications

### Classes

**Class I - Hazardous Gases.** Class I locations are areas in which flammable gases or vapors are or may be present in the air in quantities sufficient to produce explosive or ignitable mixtures.

#### Typical Class I Hazardous Areas

- Spray painting and finishing areas
- Utility gas plants
- Petroleum refining production plants
- Petroleum dispensing locations
- Dry cleaning facilities
- Dip tanks containing combustibles or flammable liquids
- Plant facilities extracting solvents
- Inhalation anesthetics areas
- Process facilities manufacturing pyroxylin type plastics

**Class II - Hazardous Dusts.** Class II locations represent areas that are hazardous due to the presence of combustible dust.

#### Typical Class II Hazardous Areas

- Flour mills
- Feed mills
- Grain elevators and grain handling facilities
- Aluminum manufacturing and storage areas
- Magnesium manufacturing and storage areas
- Coal preparation and handling facilities
- Starch manufacturing and storage areas
- Confectionery plants
- Pulverizer sugar and cocoa manufacturing, and storage plants
- Spice grinding and storage plants

**Class III - Hazardous Fibers.** Class III locations have easily ignitable fibers or flyings present, but not likely to be suspended in air in quantities sufficient to produce ignitable mixtures in the atmosphere.

#### Typical Class III Hazardous Areas

- Textile mills
- Woodworking plants\*
- Furniture manufacturers\*
- Cotton gins
- Cotton seed milling plants
- Flax plants
- Carpet manufacturers

\* Except if wood flour (dust), which is Class II Group G, is present

### Divisions

The Location Classes are broken down by the NFPA into Divisions 1 and 2, defining different levels of risk. In general, the risk of there being a hazardous presence of flammable/combustible/ignitable materials is higher for Division 1 than for Division 2. The specifics differ between the three classes (I, II and III). Equipment suitable for Division 1 is also suitable for Division 2 locations.

### Groups

Class I and II locations are divided by the NFPA into Group designations identifying specific gases, vapors and dusts by characteristic similarities that relate to specific equipment construction requirements. Class III locations are not divided into separate group designations.

#### Class I Groups

**Group A.** Atmospheres containing acetylene.

**Group B.** Atmospheres containing hydrogen, fuel and combustible process gases containing more than 30 percent hydrogen by volume, or gases or vapors of equivalent hazard such as butadiene, ethylene oxide, propylene oxide, and acrolein.

**Group C.** Atmospheres such as ethyl ether, ethylene, or other gases or vapors of equivalent hazard.

**Group D.** Atmospheres containing acetone, ammonia, benzene, butane, cyclopropane, ethanol, gasoline, hexane, methanol, methane, natural gas, naphtha (petroleum), propane, or gases or vapors of equivalent hazard.

#### Class II Groups

**Group E.** Atmospheres containing combustible metal dusts, including aluminum, magnesium, and their commercial alloys, or other combustible dusts whose particle size, abrasiveness and conductivity present similar hazards in the use of electrical equipment.

**Group F.** Atmospheres containing combustible carbonaceous dusts, including carbon black, charcoal, coal, or dusts that have been sensitized by other materials so that they present an explosion hazard.

**Group G.** Atmospheres containing combustible dusts not included in Group E or F, including flour, grain, wood, plastic, and chemicals.

SUBMIT



# Initiating Devices

## Rate Compensation Heat Detectors

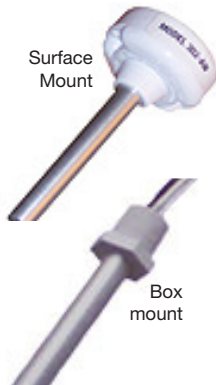

Series 302 heat detectors are designed for use in normal environments as well as environments where the detectors are subject to weather, moisture (internal condensation), and explosive atmospheres. They are normally-open devices designed to close an electrical circuit upon activation. All models feature rate compensation and are available with either 135 °F (57.2 °C) or 194 °F (90 °C) ratings. They are self restoring, hermetically sealed, shock and corrosion resistant, and are tamperproof.

Sensor's Rated Temperature	Minimum Ambient Air Temperature	Maximum Ceiling Temperature
135 °F (57.2 °C)	-40 °F (-40 °C)	100 °F (38 °C)
194 °F (90 °C)	-40 °F (-40 °C)	150 °F (66 °C)

The sensor's aluminum tube acts as a heat collector when sources of heat radiate directly on the tube. Install these sensors out of direct sunlight and away from radiating heat sources including the direct flow from heaters and heat ducts.

<input type="checkbox"/>	302-AW-135	All-weather Heat Detector - Vertical Mounting FM & UL, 135 °F (57.2 °C)	Data Sheet E85001-0589
<input type="checkbox"/>	302-AW-194	All-weather Heat Detector - Vertical Mounting FM & UL, 194°F (90 °C)	Data Sheet E85001-0589
<input type="checkbox"/>	302-ET-135	All-weather Heat Detector - Vertical, Box Mount (½" NPT), FM & UL, 135 °F (57.2 °C)	Data Sheet E85001-0589
<input type="checkbox"/>	302-ET-194	All-weather Heat Detector - Vertical, Box Mount (½" NPT), FM & UL, 194°F (90 °C)	Data Sheet E85001-0589
<input type="checkbox"/>	302-EPM-135	Heat Detector - Explosionproof Mounting UL (Not FM approved), 135 °F (57.2 °C)	Data Sheet E85001-0589
<input type="checkbox"/>	302-EPM-194	Heat Detector - Explosionproof Mounting UL (not FM approved), 194°F (90 °C)	Data Sheet E85001-0589
<input type="checkbox"/>	AP-P	Adaptor plate for mounting 302 and 302-AW to any 3" box or 4" octagon outlet box	Data Sheet E85001-0589
<input type="checkbox"/>	JALX11	Explosion proof outlet body with cover - Killark	Data Sheet E85001-0589

## Explosionproof/weatherproof Manual Stations

MPSR Series explosionproof/weatherproof manual pull stations are noncoded fire alarm stations solidly constructed of die-cast material. They are rated for Class I Group B (hydrogen) C & D, Class II Groups E, F, G, Class III environments, and are rated NEMA 4X for outdoor use. Key and screw reset models feature terminal connections and come complete with backbox.



	Hex Screw Reset	Cat 45 Key Reset	Manual Stations	Data Sheet E85001-0588
<input type="checkbox"/>	<input type="checkbox"/> MPSR1-DHTWX-GE	<input type="checkbox"/> MPSR1-D45WX-GE	Explosionproof Single-action, SPST with backbox.	
<input type="checkbox"/>	<input type="checkbox"/> MPSR1-SHTW-GE	<input type="checkbox"/> MPSR1-S45W-GE	Weatherproof Single-action, SPST with backbox.	
<input type="checkbox"/>	<input type="checkbox"/> MPSR1-DHTW-GE	<input type="checkbox"/> MPSR1-D45W-GE	Weatherproof Single-action, DPDT with backbox.	
<input type="checkbox"/>	<input type="checkbox"/> MPSR2-SHTW-GE	<input type="checkbox"/> MPSR2-S45W-GE	Weatherproof Double-action, SPST with backbox.	
<input type="checkbox"/>	<input type="checkbox"/> MPSR2-DHTW-GE	<input type="checkbox"/> MPSR2-D45W-GE	Weatherproof Double-action, DPDT with backbox.	
<input type="checkbox"/>	<input type="checkbox"/> MPSR2-SHTW-GE-NYW	<input type="checkbox"/> MPSR2-S45W-GE-NYW	Weatherproof Double-action, SPST with backbox, NYC white stripe.	
For French markings add <i>-F</i> to the suffix of the model number. For bilingual French/English markings add <i>-B</i> to the suffix of the model number.				
<input type="checkbox"/>	MPSR-LP	Double action cover for explosionproof manual stations		
<input type="checkbox"/>	MPSRGR10	Replacement glass rods for MPSR stations (10 pack).		
<input type="checkbox"/>	276-K1	Cat 45 Key (each)		



### Explosionproof Smoke Detector

Model 30-3013 detectors are high performance smoke detectors built for use in hazardous locations. They are corrosion-resistant and feature a non-conducting aluminum alloy retaining ring that protects the detector sensor against the effects of explosions and other catastrophic events. The retaining ring mounts securely to a companion junction box, which offers several common port configurations for conduit connection. Together, the ring and box provide a sturdy protective shell for the detector head.

30-3013A1N12F

Explosionproof Smoke Detector

Data Sheet E85001-0645



## Notification Appliances

### Hazardous Location Strobes

- Class I, II, or III locations

116DEGEX-FJ hazardous location strobes are life safety signaling appliances designed for installation in hazardous environments. State-of-the-art technology provide for high visual output and low maintenance. The 116DEGEX-FJ has negligible in-rush current. When pendant, wall or ceiling mounted, the 116DEGEX-FJ meets or exceeds the requirements of UL 1971 Signaling Appliance for the Hearing Impaired.



116DEGEX-FJ	Explosionproof Strobe, Diode Polarized	Data Sheet E85001-0624	<input type="checkbox"/>
116EX-B	Wall bracket mounting elbow (required for wall mount applications)	Data Sheet K85001-0624	<input type="checkbox"/>
116EX-C	Ceiling/wall mounting module (required for wall mount applications)	Data Sheet K85001-0624	<input type="checkbox"/>
116EX-P	Pendant mounting module - 3/4" (19 mm) NPT	Data Sheet E85001-0624	<input type="checkbox"/>
116-GRD	Lens Guard	Data Sheet E85001-0624	<input type="checkbox"/>

### Hazardous Location Bells

- Class I groups B, C and D locations
- Class II groups E, F and G locations
- Class III hazardous locations, for Divisions 1 and 2

430D series of hazardous location bells are diode-polarized, heavy duty fire bells for use in life safety applications where a diode supervised signal is required. They can be mounted to any solid surface using two 3/8 inch (10 mm) bolts and the supplied mounting brackets or to a rigid conduit. The integral explosion-proof housing is mechanically terminated to accept a standard 3/4 inch -14 National Pipe Taper (NPT) nipple.



<input type="checkbox"/> 439DEX-6AW (6")	<input type="checkbox"/> 439DEX-8AW (8")	<input type="checkbox"/> 439DEX-10AW (10")	Bell – 24 Vdc, Red	Data Sheet K85001-0399	<input type="checkbox"/>
<input type="checkbox"/> 439DEX-6AW-R (6")	<input type="checkbox"/> 439DEX-8AW-R (8")	<input type="checkbox"/> 439DEX-10AW-R (10")	Bell – 24 Vdc, Grey	Data Sheet K85001-0399	<input type="checkbox"/>

### Hazardous Location Horns

- Class I groups B, C and D locations
- Class II groups E, F and G locations
- Class III hazardous locations, for Divisions 1 and 2

888D and 889D hazardous location horns are diode-polarized, heavy duty, high decibel vibrating horns intended for use in life safety systems in hazardous (classified) locations. These horns may be mounted to any solid surface using two bolts. Each unit is supplied with a sealing fitting for a 3/4 inch -14 National Pipe Taper (NPT) nipple, and wire leads for the electrical connection to the life safety system notification appliance circuit.

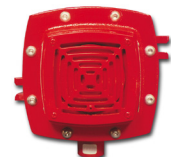

<input type="checkbox"/> 888D-N5 (120 Vac)	<input type="checkbox"/> 889D-AW (24 Vdc)	Horn – 120 Vac	Data Sheet E85001-0397	<input type="checkbox"/>
--	---	----------------	------------------------	--------------------------

SUBMIT



## Door Holders



24 Vac 60 Hz  
24 Vdc  
120 Vac 60 Hz

### Electromagnetic Door Holders

Electromagnetic door holders keep doors open until signaled by the fire alarm system, a heat detector, a smoke detector, or an electrical switch. Door holders should be installed wherever doors may be effectively used to confine smoke and fire, or where the release of a self-closing door from a remote location is required. Fail-safe operation is an inherent feature of these door holders. If power fails, doors are released automatically, but may be opened or closed manually at any time. All units are free of moving parts, are self-contained, and require no maintenance. Door holders have a holding force of approximately 15-25 Lbf (66-111N).

<input type="checkbox"/>	<input type="checkbox"/> 1501-AQN5 (Single Door)	<input type="checkbox"/> 1502-AQN5 (Double Door)	Floor Mounted	Data Sheet E85001-0421
<input type="checkbox"/>	<input type="checkbox"/> 1504-AQN5 (Long Catch Plate)	<input type="checkbox"/> 1505-AQN5 (Short Catch Plate)	Flush Wall Mounted	Data Sheet E85001-0421
<input type="checkbox"/>	<input type="checkbox"/> 1508-AQN5 (Surface)	<input type="checkbox"/> 1509-AQN5 (Completely flush)	Wall Mounted	Data Sheet E85001-0421
<input type="checkbox"/>	<input type="checkbox"/> 1500-1 (1.5" Extension)	<input type="checkbox"/> 1500-2 (2.5" Extension)	Catch Plate	Data Sheet E85001-0421
<input type="checkbox"/>	<input type="checkbox"/> 1500-7 (5.25 to 7.5" Extension)	<input type="checkbox"/> 1500-12 (7.5 to 12" Extension)	Catch Plate	Data Sheet E85001-0421
<input type="checkbox"/>	<input type="checkbox"/> CS2595-5 (short)	<input type="checkbox"/> CS2598-5 (long)	Replacement Armature	Data Sheet E85001-0421

## Relays



### Four-Voltage SPDT/DPDT Control Relays

MR Series multi-voltage control relays are ideal for applications where local contacts are required for system status, remote contacts, or for control of electrical loads and general purpose switching. They are suitable for use with HVAC temperature control, fire alarm, security, energy management, and lighting control systems. Relays provide 10-Amp contacts, which may be operated by one of four input control voltages. Each relay position contains a red LED that indicates the relay coil is energized. Relays may be snapped apart from a standard four-module assembly and used independently.

<input type="checkbox"/>	<input type="checkbox"/> MR-101/T (with mounting hardware)	<input type="checkbox"/> MR-101/C (in metal enclosure)	Single SPDT relay	Data Sheet E85300-02762
<input type="checkbox"/>	<input type="checkbox"/> MR-104/T (with mounting hardware)	<input type="checkbox"/> MR-104/C (in metal enclosure)	4-position SPDT relay	Data Sheet E85300-02762
<input type="checkbox"/>	<input type="checkbox"/> MR-201/T (with mounting hardware)	<input type="checkbox"/> MR-201/C (in metal enclosure)	Single DPDT relay	Data Sheet E85300-02762
<input type="checkbox"/>	<input type="checkbox"/> MR-204/T (with mounting hardware)	<input type="checkbox"/> MR-204/C (in metal enclosure)	4-position DPDT relay	Data Sheet E85300-02762



### Heavy Duty DPDT Power Relays

MR-199 heavy duty power relays are designed for control applications where 30-Amp DPDT contacts are required. Two models are available: a 115Vac coil and a 24Vdc coil, each of which may be mounted in a rugged steel enclosure.

<input type="checkbox"/>	<input type="checkbox"/> MR-199X-13 (relay only)	<input type="checkbox"/> MR-199X-13/C (in metal enclosure)	Power Relay — 24 VDC	Data Sheet E85300-02765
<input type="checkbox"/>	<input type="checkbox"/> MR-199AX-14 (relay only)	<input type="checkbox"/> MR-199AX-14/C (in metal enclosure)	Power Relay — 120 VDC	Data Sheet E85300-02765





## SPDT Relays

Single-pull/double-throw relays are ideal for applications where local or remote contacts are required for control of electrical loads. They are suitable for use with HVAC, temperature control, fire alarm, security, energy management, and lighting control systems. Each relay position contains a high-intensity LED which, when illuminated, indicates the relay coil is energized. Individual relay circuits may be snapped apart from standard four- or eight-position modules, and are also available in a single-circuit configuration. The common power to each relay position is bussed on the printed wiring board, which permits power to be connected only once per multi-position module.

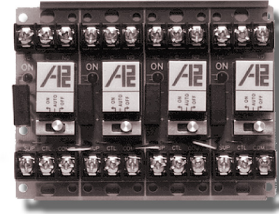

### Single-Voltage Manual Override Relays

MR-600 series relays provide SPDT, 10-Amp contacts with manual override capability by means of an ON-AUTO-OFF switch. The relay requires a 24Vac or 24Vdc power source supplied by the controlling system. With the switch in the ON position the power relay is energized. With the switch in the AUTO position the relay is allowed to operate as signaled by the controlling system. With the switch in the OFF position the relay cannot be energized.

<input type="checkbox"/> MR-601/T (with mounting track)	<input type="checkbox"/> MR-601/S (with mounting spacers)	Single SPDT relay	Data Sheet E85300-02761	<input type="checkbox"/>
<input type="checkbox"/> MR-604/T (with mounting track)	<input type="checkbox"/> MR-604/S (with mounting spacers)	4-position SPDT relay	Data Sheet E85300-02761	<input type="checkbox"/>
<input type="checkbox"/> MR-608/T (with mounting track)	<input type="checkbox"/> MR-608/S (with mounting spacers)	8-position SPDT relay	Data Sheet E85300-02761	<input type="checkbox"/>

### Three-Voltage Control Relays

MR-800 Series relays provide SPDT 10-Amp contacts that may be operated by one of three input control voltages: 24Vdc, 24Vac or 115Vac.

<input type="checkbox"/> MR-801/T (with mounting track)	<input type="checkbox"/> MR-801/S (with mounting spacers)	Single SPDT relay	Data Sheet E85300-02763	<input type="checkbox"/>
<input type="checkbox"/> MR-804/T (with mounting track)	<input type="checkbox"/> MR-804/S (with mounting spacers)	4-position SPDT relay	Data Sheet E85300-02763	<input type="checkbox"/>
<input type="checkbox"/> MR-808/T (with mounting track)	<input type="checkbox"/> MR-808/S (with mounting spacers)	8-position SPDT relay	Data Sheet E85300-02763	<input type="checkbox"/>

### Four-Voltage Control Relays

MR-700 Series relays provide SPDT 10-Amp contacts that may be operated by one of four input control voltages: 12Vdc, 12Vac, 24Vdc, or 24Vac.

<input type="checkbox"/> MR-701/T (with mounting track)	<input type="checkbox"/> MR-701/S (with mounting spacers)	Single SPDT relay	Data Sheet E85300-02764	<input type="checkbox"/>
<input type="checkbox"/> MR-704/T (with mounting track)	<input type="checkbox"/> MR-704/S (with mounting spacers)	4-position SPDT relay	Data Sheet E85300-02764	<input type="checkbox"/>
<input type="checkbox"/> MR-708/T (with mounting track)	<input type="checkbox"/> MR-708/S (with mounting spacers)	8-position SPDT relay	Data Sheet E85300-02764	<input type="checkbox"/>

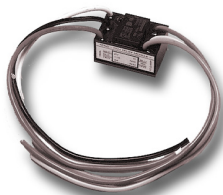

### Three-Voltage Encapsulated Control Relays

PAM-1 relays provide 10-Amp Form C contacts. The relay may be energized by one of three input voltages: 24Vac, 24Vdc, or 115Vac. The PAM-1 may be mounted with double-sided adhesive tape, a self-tapping screw, or loosely placed in a backbox.

PAM1	Encapsulated SPDT relay	Data Sheet E85300-02766	<input type="checkbox"/>
------	-------------------------	-------------------------	--------------------------



# EDWARDS

 United Technologies

Proven leadership.  
Proud heritage.  
Shared vision.

In 1872 when Robert Edwards installed an electrically-operated gas lamp igniter in a New York City church, he began a tradition of innovation that would chart the course of building safety and security for the next 140 years. Today the company that bears his name draws on this rich legacy of inventiveness, and benefits from fresh new alliances established with one underlying goal: uncompromised excellence.

Today EDWARDS meets this goal with quality products and an

exceptional sensitivity to the needs of our customers. Now we have access to the resources, talent, and experience that is already setting a coordinated plan for excellence into action. The result is a unique synergy sustained by a strong organization with a well-defined vision of the future.

That vision of excellence is why EDWARDS is among the fastest growing building systems providers today. It's also why, with more than a century of solid growth behind us, you can put your trust in EDWARDS.

See what's possible now.

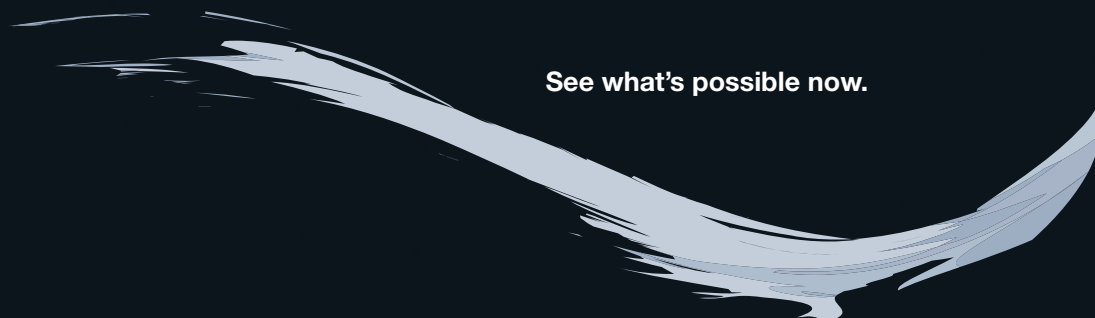

EDWARDS Strategic Partners:

## Innovation, leadership, and a rich tradition of excellence...

Whether EDWARDS life safety systems are protecting the lives and livelihoods of the people who make businesses run, or the lives entrusted to the care of public institutions; whether they're charged with protecting the guests of the world's finest hotels, or preserving irreplaceable artifacts that bring history to life; EDWARDS stands alone as the brand closely associated with some of the most important and far-reaching developments in the life safety industry today.

Our strength is in our Strategic Partners — the people and organizations we entrust with the technology that has charted the course of life safety protection for decades. Strategic Partners are not middlemen or go-betweens. They are independent contractors who add value to the EDWARDS life safety solution. As insiders, they enjoy exclusive access to products, custom design innovations, and factory training. Yet as successful independent contractors, they are adept at ensuring that each submittal is strong and competitive, and that each bid is locally relevant to your installation. As local businesses they not only have to earn your trust — they have to keep it.

Together these strengths set EDWARDS installations apart, and have earned this brand a special place among life safety and security solutions available today. Perhaps that's why many of the world's most cherished landmarks are protected by EDWARDS products. From the Bibliotheca Alexandrina Museum in Egypt, to the modern-day sphinx at the Luxor Hotel in Las Vegas, professionals who design, own and occupy the world's most impressive structures have chosen the EDWARDS solution.

See what's possible now...

Contact your EDWARDS Strategic Partner today!



LIFE SAFETY & INCIDENT MANAGEMENT

### Contact us

Phone: 800-655-4497 Option 1  
Fax: 866-226-2126  
Email: [edwards.techsupport@fs.utc.com](mailto:edwards.techsupport@fs.utc.com)  
Web: [edwardsfiresafety.com](http://edwardsfiresafety.com)

8985 Town Center Pkwy  
Bradenton, FL 34202

EDWARDS is a registered mark in the United States and other countries.

© 2019 United Technologies Corporation.  
All rights reserved.



E85005-0132