



INSTALLATION AND PROGRAMMING MANUAL

**Intelligent Interactive Analogue Addressable
Fire Alarm Control Panel**

SIMPO

Attention:

This manual contains information on limitations regarding product use and function and information on the limitations as to liability of the manufacturer. The entire manual should be carefully read.

The information in this manual is a subject to change without notice!



Table of Contents

1. INTRODUCTION	5
1.1. General Description.....	5
1.2. General Specifications	5
1.2.1 General Technical Specifications.....	5
1.2.2 Possible Hardware Configurations.....	6
1.2.3 Environment.....	6
1.2.4 Electrical Characteristics.....	6
2. INSTALLATION	8
2.1. Wall Mounting.....	8
2.2. System Components	9
2.2.1 Front panel.....	9
2.2.2 Configuration of the basic modules.....	11
2.2.3 Description of the main PCB (control panel).....	11
2.3. Connection of Signaling Devices.....	13
2.3.1 Connecting of Sounders.....	13
2.3.2 Connecting of Signaling Devices	13
2.3.3 Connecting to the Specialized Inputs.....	13
2.3.4 Loop Controller.....	14
2.3.5 Maximum Permissible Cable Length.....	15
2.4. Connecting to the Main Power Source.....	16
2.5. Connecting the Accumulator Battery.....	16
2.6. Connecting a Heat Printer.....	17
2.7. Connecting a Network Module	17
3. PROGRAMMING TYPES	18
3.1. Programming via ProsTE Software.....	18
3.2. Programming via Panel’s Keyboard	18
3.3. Firmware Update.....	18
3.3.1 Firmware Update from Computer.....	18
3.3.2 Firmware Update from USB Drive.....	19
3.3.3 Copying Image File from the Panel to USB Drive	19
4. FULL HARDWARE RESET	19
5. PROGRAMMING OF SIMPO FIRE ALARM PANEL	20
5.1. General Information for Programming and Operation	20
5.2. Codes and Access Levels.....	20
6. DESCRIPTION OF THE OPERATION MODES	22
6.1. Review of Alarm Events	22
6.2. Review of Fault Events.....	22
6.3. Review of Disablements.....	23
6.4. Review of Running Tests	23
6.5. Review of Warning Messages.....	24
6.6. Silencing the Internal Buzzer.....	25
6.7. Silencing the Sounders	25
6.8. Activate Evacuation.....	25
6.9. Resetting the Panel.....	25
6.10. Indication Test.....	25
7. DESCRIPTION OF THE PROGRAMMING MENUS	26
7.1. View History Log Menu	26
7.1.1 Review of Full Events List.....	26
7.1.2 Review of List of Events by Date	27
7.1.3 Deleting the Events in the LOG file	27
7.1.4 Printing Events.....	27
7.1.5 Printer Settings.....	27
7.2. Zones Menu	28
7.2.1 General Submenus	28
7.2.2 Zones Testing	28
7.2.3 Disabling Zones	29
7.2.4 Programming Zone Parameters.....	29
7.2.5 Zone Name	29
7.2.6 Zone Operation Modes	29
7.2.7 Programming Delays T2	30
7.2.8 Arranging Zones in Groups.....	31
7.3. Devices Setup Menus	31
7.3.1 Submenus for General Setting.....	31
7.3.2 Saving the New Found Devices.....	32
7.3.3 Deleting Devices	32

7.3.4 Disabling Devices.....	33
7.3.5 Fixing of Wrong Type Devices	33
7.3.6 Programming of Device Parameters	33
7.4. Addressing Menus.....	44
7.4.1 Set Address.....	45
7.4.2 Change Address	45
7.4.3 Self-Addressing.....	45
7.4.4 Auto-Addressing.....	46
7.5. Panel Outputs Menus.....	47
7.5.1 Sounders Outputs	47
7.5.2 Extinguishing Output	47
7.5.3 Fire Output	48
7.5.4 Fault Output	48
7.5.5 Relay Outputs	48
7.6. General Settings Menu.....	49
7.6.1 Access Codes	49
7.6.2 Setting the Date and Time	50
7.6.3 Setting Day/ Night Alarm Modes	50
7.6.4 Panel General Settings	51
7.6.5 Delay T1	51
7.6.6 Sounders Mode.....	51
7.6.7 Company Logo.....	52
7.7. Save Configuration Menu.....	53
7.8. Restore Defaults Menu.....	53
7.9. Software Revision	53
7.10. Network	53
7.10.1 Network Settings	53
7.10.2 Panels Settings	54
7.11. Active Isolators Menu	55
7.12. Access Level 1	55
APPENDIX A	56
APPENDIX B	58
APPENDIX C	58
APPENDIX D	59
APPENDIX E	60



1293

DoP No: 001

Teletek Electronics JSC

Bulgaria, Sofia 1407, 14A Srebarna Str., Tel.: +359 2 9694 800, Fax: +359 2 962 52 13

e-mail: info@teletek-electronics.bg

EN 54-2:1997/A1:2006/AC:1999; EN 54-4:1997/A2:2006/AC:1999

SIMPO

Intended for use in fire detection and fire alarm systems in and around buildings.

Essential Characteristics	Performance
Performance under fire conditions	Pass
Response delay (response time to fire)	Pass
Operational reliability	Pass
Durability of operational reliability and response delay: temperature resistance	Pass
Durability of operational reliability: humidity resistance	Pass
Durability of operational reliability: vibration resistance	Pass
Durability of operational reliability: electrical resistance	Pass

GUARANTEE

The guarantee terms are determined by the serial number (barcode) of the electronic device!

During the guarantee period the manufacturer shall, at its sole discretion, replace or repair any defective product when it is returned to the factory. All parts replaced and/or repaired shall be covered for the remainder of the original guarantee, or 6 months, whichever period is longer. The original purchaser shall immediately send manufacturer a written notice of the defective parts or workmanship.

INTERNATIONAL GUARANTEE

Foreign customers shall possess the same guarantee rights as those any customer in Bulgaria, except that manufacturer shall not be liable for any related customs duties, taxes or VAT, which may be payable.

GUARANTEE PROCEDURE

The guarantee will be granted when the appliance in question is returned. The guarantee period and the period for repair are determined in advance. The manufacturer shall not accept any product, of which no prior notice has been received via the RAN form at: <http://teletek-electronics.com/en/ran-form>

The setup and programming included in the technical documentation shall not be regarded as defects. Teletek Electronics bears no responsibility for the loss of programming information in the device being serviced.

CONDITIONS FOR WAIVING THE GUARANTEE

This guarantee shall apply to defects in products resulting only from improper materials or workmanship, related to its normal use. It shall not cover:

- Devices with destroyed serial number (barcode);
- Damages resulting from improper transportation and handling;
- Damages caused by natural calamities, such as fire, floods, storms, earthquakes or lightning;
- Damages caused by incorrect voltage, accidental breakage or water; beyond the control of the manufacturer;
- Damages caused by unauthorized system incorporation, changes, modifications or surrounding objects;
- Damages caused by peripheral appliances unless such peripheral appliances have been supplied by the manufacturer;
- Defects caused by inappropriate surrounding of installed products;
- Damages caused by failure to use the product for its normal purpose;
- Damages caused by improper maintenance;
- Damages resulting from any other cause, bad maintenance or product misuse.

In the case of a reasonable number of unsuccessful attempts to repair the product, covered by this guarantee, the manufacturer's liability shall be limited to the replacement of the product as sole compensation for breach of the guarantee. Under no circumstances shall the manufacturer be liable for any special, accidental or consequential damages, on the grounds of breach of guarantee, breach of agreement, negligence, or any other legal notion.

WAIVER

This Guarantee shall contain the entire guarantee and shall be prevailing over any and all other guarantees, explicit or implicit (including any implicit guarantees on behalf of the dealer, or adaptability to specific purposes), and over any other responsibilities or liabilities on behalf of the manufacturer. The manufacturer does neither agree, nor empower, any person, acting on his own behalf, to modify, service or alter this Guarantee, nor to replace it with another guarantee, or another liability with regard to this product.

UNWARRANTED SERVICES

The manufacturer shall repair or replace unwarranted products, which have been returned to its factory, at its sole discretion under the conditions below. The manufacturer shall accept no products for which no prior notice has been received via the RAN form at: <http://teletek-electronics.com/en/ran-form>.

The products, which the manufacturer deems repairable, will be repaired and returned. The manufacturer has prepared a price list and those products, which can be repaired, shall be paid for by the Customer. The devices with unwarranted services carry 6 month guarantee for the replaced parts.

The closest equivalent product, available at the time, shall replace the products, the manufacturer deems un-repairable. The current market price shall be charged for every replaced product.

STANDARDS AND CONFORMITY

The addressable fire alarm control panel SIMPO is designed according and with conformity to EN 54 – 2/4 standard.

Conforms and approved in accordance with CPR (Construction Products Regulation).

DOCUMENTATION FEEDBACK

If you have any comments or suggestions on our products' manuals or installation instructions you can email us on: info@teletek-electronics.bg

Your feedback on product documentation will help us to improve the contents of our manuals and stickers and keep them up-to-date.

Please, include in your feedback email the product name, the revision of the manual or instruction (8-digit number with Revision and date of issue) and the page number.

1. INTRODUCTION

1.1. General Description

SIMPO is an addressable fire panel with maximum coverage of 48 zones and connecting and up to 2 loops. The panel supports communication protocol *Teletek Electronics (SIMPO TTE Loop)* and operation with SensolRIS addressable device series.



Every SIMPO TTE Loop provides up to 250 devices (detectors and modules, regardless of the type).

An arbitrary number of devices can be added to each zone thus ensuring the easy adaptation of the system to any type of configuration.

To avoid or significantly diminish problems when mounting the system it must be carefully planned prior to installation. This includes: setting an address for every device and planning a name of maximum 40 digits (including the spaces) for each address, thereby ensuring easy access to the device.

According to the acting standards for establishing fire systems and the plan of the building, the devices must be grouped in zones.



1.2. General Specifications

The front panel consists of LCD module (4 rows x 40 symbols), functional buttons and system status LED indication. Separate access level passwords provide access to the functions of the panel.

The fire alarm panel is designed on module structure as in the metal cabinet there are provided additional places for mounting of a second loop controller for Loop 2 (Loop 1 is built-in the main PCB), a communication module and redundant network module.

The panel has a built-in real time clock and calendar, allowing day and night time modes of work.

Switching over between the two modes can be automatic or manual. Events like FIRE, RESET, FAULT, etc., are saved in the memory, thereby creating an event log-file. It contains the time and date, the address of the device, the name of the device, the zone number, the name of the zone, etc.

1.2.1 General Technical Specifications

- Loops - 1 to 2:
 - Loop 1 is built-in in the main board
 - Loop 2 – optional, separately mounted to the main control panel
- Number of loop devices:
 - Up to 250 devices (modules and/ or detectors regardless of the type) for every loop (max. 500 for the entire system)
- 48 operation zones (*Note: Zone numbers 17-48 do not cover the requirements of EN54-2/4. There is no LED indication for the status of zones 17-48 on the front panel.*)

- 9 groups for zones' organization
- 5 monitored potential outputs:
 - SND1 (Sounder 1)
 - SND2 (Sounder 2)
 - FIRE
 - FAULT (The output is deactivated in case of fault event.)
 - EXT (Extinguishing/ Fire Protection – An output for sending an fire alarm signal to automatic fire extinguishing system)
- 3 specialized inputs:
 - In AmC* (Input Alarm Confirmation)
 - In PC* (Input Protection Alarm Confirmation)
 - In FP* (Input Fault Protection Panel)

* Covers the requirements on standard VdS 2540
- 4 non-monitored, programmable relay outputs with parameters: 15A@24VDC
- Display – letter and digits LCD module (4 rows x 40 symbols)
- Built-in real time clock, supported from integrated lithium battery - 3V, CR3032 type
- Memory log file for up to 10000 system events
- Comprehensive day/night mode facility
- 2 Steps of alarm levels (T1 and T2)
- Supports external thermo printer
- Multilanguage support for operation menus
- Easy software update via computer or USB drive
- Designed according the requirements of EN54-2/4
- Metal box cabinet for wall mounting: bottom (306x412x81mm) and cover (310x416mm)

1.2.2 Possible Hardware Configurations

- **Minimal Configuration**
 - Control panel (main PCB with one built-in loop controller)
 - Indication (indication PCB with mounted LCD module)
 - Power supply source
- **Maximal Configuration**
 - Control panel (main PCB with one built-in loop controller)
 - Indication (indicator PCB with mounted LCD module)
 - Power supply source
 - SIMPO TTE Loop controller (for the second loop)
 - Communication module
 - RS485 Redundant Network controller

1.2.3 Environment

- Degree of protection: IP30
- Operation temperature: -5°C up to +40°C
- Relative humidity: до 95% (without condense)
- Storage temperature: -10°C up to +60°C
- Weight (without the battery): ~ 4.2 kg.

1.2.4 Electrical Characteristics

Earth Connection

The earth connection has to be realized in accordance with the rules for the electrical safety with the total resistance in the circuit lower than 10Ω. It is mandatory to connect the main power supply cable to the middle input of the fire panel terminal – see also item 2.4 Main power connection.



ATTENTION: Do not instal the fire panel near power electromagnetic fields (radio equipment, electric motors, etc.)!

Main power supply

In normal operating conditions, the fire panel is powered from the mains voltage line. In case of mains voltage line loss the fire panel is equipped with one rechargeable battery. The characteristics of the main power supply are as follows:

- Main power supply: 90 ÷ 264 VAC
- Frequency: 47 ÷ 440 Hz
- Electrical output: 4.2 A

Backup (accumulator) power supply

- Voltage output (U): 13,65V
- Accumulator battery: 1 x 12V / 18Ah, sealed lead-acid type rechargeable battery
- Internal resistance of the accumulator battery R_i : < 0.3Ω
- Max. dimensions of the accumulator battery: 167x181x76mm
- Type of the battery connection: with a cable lug, Ø5mm (M5) or cable shoe (according the type of the battery terminals)

Loading capacity

- Max. loading capacity of one loop: 500 mA DC
- Max. loading capacity of AUX output: 500 mA DC
- Max. loading capacity of outputs *SND1* and *SND2*: 500 mA DC
- Max. loading capacity of outputs *FIRE*, *FAULT* and *EXT*: 300 mA DC
- Max. total loading capacity (sum of the four mentioned above): 2.0 A DC
- Programmable relay outputs: 15A@24VDC







Consumption

- From the main power supply in standby mode:
 - For a minimum configuration: 60 mA AC
 - With mounted second loop controller: 65 mA AC
- From the backup power supply in FAULT mode and generated message 'AC loss':
 - For a minimum configuration: 125 mA DC
 - With mounted second loop controller: 213 mA DC

List of the used fuses

- Main power supply: 4A, T type, glass time-delay fuse, size 5x20mm
- AUX output: 0.5A, PTC type, resettable fuse
- Outputs: 0.3A, PTC type, resettable fuse
- Accumulator: 7.0A, PTC type, resettable fuse

List of spare parts kit:

1		Resistor 10k ± 5%, 0.25W	6 pcs
2		Resistor 47k ± 5%, 0.25W	4 pcs
3		Resistor 20k ± 5%, 0.25W	3 pcs
4		Screw 4.2x38, cross slot DIN7981	4 pcs
5		Anchor 6x30mm	4 pcs
6		Fuse 4A, glass time-delay type 5x20mm (for the power supply)	4 pcs



ATTENTION!

Qualified specialists only should install the panel.

The electronic components of the panel are vulnerable to electrostatic discharge.

Never add or turn off components which are being power supplied!

2. INSTALLATION

2.1. Wall Mounting

- The panel must be installed in a clean dry place and must not be subjected to impact or vibrations (Figure 1). It must be situated far from heating appliances. The temperature must be within -5°C and $+40^{\circ}\text{C}$. The fire panel is not waterproof!
- Unpack the panel and observe for visible damages due to bad transport or incorrect storing.
- Open the front cover and disconnect the flat indication cable and the earthing point (Figure 2).

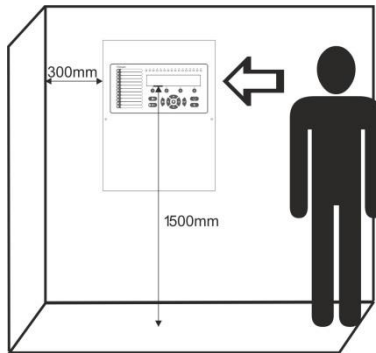

Figure 1

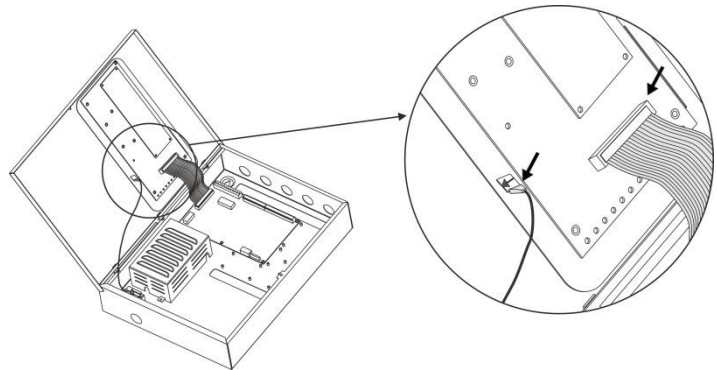

Figure 2

- Remove the front cover as dismount the side hinges (Figure 3).

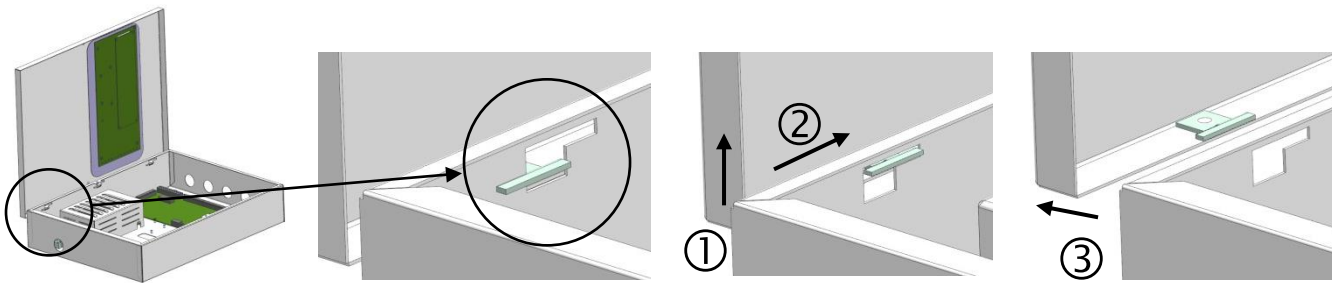

Figure 3

- Choose inlets for the main power supply cable, loops, sounders, control devices, etc. Remove the metal cap element just from those holes for cable running (Figure 4).

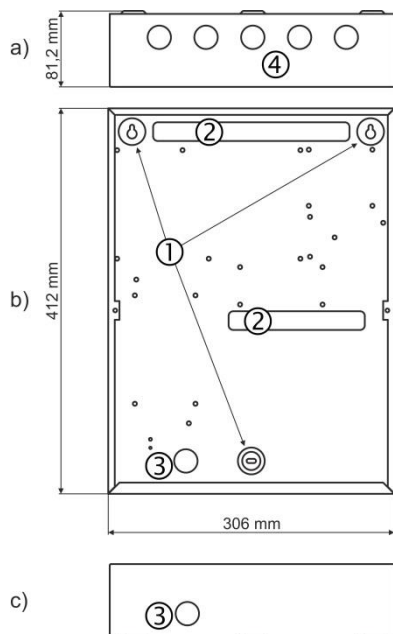

Figure 4 – Elements of the metal bottom:

- a) View from above;
- b) Front view;
- c) View from below.

- 1 – Main mounting holes.
- 2 – Holes for cable running.
- 3 – Holes for main power supply cable running, protected with a metal cap element.
- 4 – Additional holes for cable running, protected with a metal cap element.

- Use the template in the set to fix the mounting holes of the metal box on the wall.
- Drill holes (suitable for anchors Ø6mm) on the wall and fix the metal box.
- Route the external cables onto the back box, make off connection glands etc., BUT DO NOT make any connections at this stage. ENTER THE MAINS CABLE THROUGH ITS OWN CABLE ENTRY POINT AND KEEP MAINS WIRING AWAY FROM SYSTEM AND OTHER LOW VOLTAGE WIRING.
- Connect the mains supply and earth to the power supply terminal (see Figure 16), BUT DO NOT apply the main electrical supply at this stage.
- Place the battery in an upright position.
- Mount the front cover back to the bottom as mount the hinges in the reverse order of that described on Figure 3.
- Connect back the flat cable for the indication and the earthing point (Figure 2).
- Proceed with initial power up of the system and testing.
- When you finish with power up and testing steps and the panel is normal operation mode you must fix the front cover to the bottom with the two screws from the spare parts kit.

2.2. System Components

2.2.1 Front panel

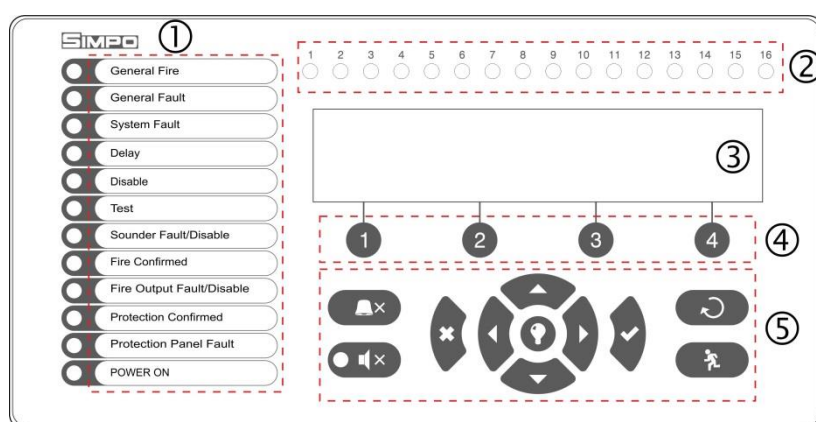

Description of the front panel elements:

- 1 – LED indication for the system status. The descriptions are printed on the paper label and can be changed if needed, including for language change. The paper label is placed in a special opening on the inner side of the indicator PCB, over the flat cable for the indication.
- 2 – LED indication for the used zones
- 3 – Letters and digits LCD-module (4x40)
- 4 – Functional digits buttons
- 5 – Control and navigation buttons

Figure 5

1 – Description of system status LED indication:

LED	Indication/ Description
GENERAL FIRE (red)	Lights on permanently in case of fire alarm event – fire alarm signal from an automatic or manual call point, or other auxiliary device connected to a panel input.
GENERAL FAULT (yellow)	Lights on permanently in case of fault event in the system.
SYSTEM FAULT (yellow)	CPU FAULT. Lights on permanently in case of main microprocessor fault.
DELAY (yellow)	Lights on permanently in daytime mode and set time delay for one or several outputs.
DISABLE (yellow)	Light on permanently in active disablement in the system.
TEST (yellow)	Light on permanently in system test mode.
SOUNDERS FAULT/ DISABLED (yellow)	The LED will be active in case of fault or disablement of the sounders circuits. The indication is as follows: <ul style="list-style-type: none"> - Blinking in case of fault event in the sounder circuits. - Lighting on when the sounder circuits are disabled.
FIRE CONFIRMED (yellow)	FIRE ALARM CONFIRMATION. Lights on permanently in activation of the specialized “In AmC” input – see the description on page 12.
FIRE OUTPUT FAULT/ DISABLED (yellow)	The LED will be active in case of fault or disablement of the FIRE relay output. The indication is as follows: <ul style="list-style-type: none"> - Blinking in case of fault event. - Lighting on when the output is disabled.

PROTECTION CONFIRMED (yellow)	EXTINGUISHING STARTED CONFIRMATION. Lights on permanently in activation of the specialized “In PC” input – see the description on page 12.
PROTECTION PANEL FAULT (yellow)	EXTINGUISHING SYSTEM FAULT. Lights on permanently in activation of the specialized “In FP” input – see the description on page 12.
POWER ON (green)	MAIN POWER SUPPLY ON. Lights on permanently in presence of 230V main power supply.
SILENCE ALARM (yellow)	THE SOUNDERS ARE SILENCED. Lights on permanently when the sounders are silenced (the LED is situated next to the button).

2 – Description of the zone LED indication:

LED	Indication/ Description
Zone indicators (red) 1 - 16	FIRE IN A ZONE. Lights on permanently in case of fire alarm in zones 1-16. Blinking when zones 1-16 are in test mode. <i>Note: For zones from 17 to 48 there is no LED indication.</i>









3 – Description of the LCD-module

The SIMPO fire alarm addressable panel is equipped with letter-digit LCD-module (4 rows x 40 symbols). The user can enter device and zone names using the navigation and control buttons. The display has an adjustable backlight with 20 levels of intensity.

4 – Description of the functional digit buttons:

Button	Description
Functional digit buttons 1 - 4	The buttons are active at access levels 2 and 3, and have the following meaning: <ul style="list-style-type: none"> - Introducing of access codes. - Functional submenu entry. - Changing of value or parameter status.

5 – Description of control and navigation buttons:

Button	Action	Description
	Silence Buzzer	The button is active at access levels 1, 2 and 3. The button functionality is deactivation of the internal buzzer.
	Silence Sounders	The button is active at access levels 2 and 3. The button functionality is deactivation of the sounders in case of fire alarm event. After pressing the button the LED next to it is lighting in yellow.
	Reset	The button is active at access levels 2 and 3. The button functionality is resetting the panel without switching off the main power supply.
	Evacuation	The button is active at access levels 1*, 2 and 3. The button immediately activates the sounders – the sounder delay is ignored if present. <i>* In case of fire alarm event in a zone and set sounder delay.</i>
	Buzzer and LED general test	The button will activate all LEDs on the front panel – for events and zones, as and the internal buzzer. The next pressing of the button deactivates the test.
	ENTER (Confirmation)	The button is active at access levels 1, 2 and 3. Use the button to confirm the entered values and parameters; in the devices and zones menus use the button to enter in a submenu for name and status changing.
	CANCEL (Rejection)	The button is active at access levels 1, 2 and 3. Use the button to reject the entered values and parameters; one step back to the previous menu.
	Navigation buttons	The button is active at access levels 2 and 3. Use the arrows to scroll over the menus; in the programming menus the buttons has a specific function for changing values and switching between the editable fields.

2.2.2 Configuration of the basic modules

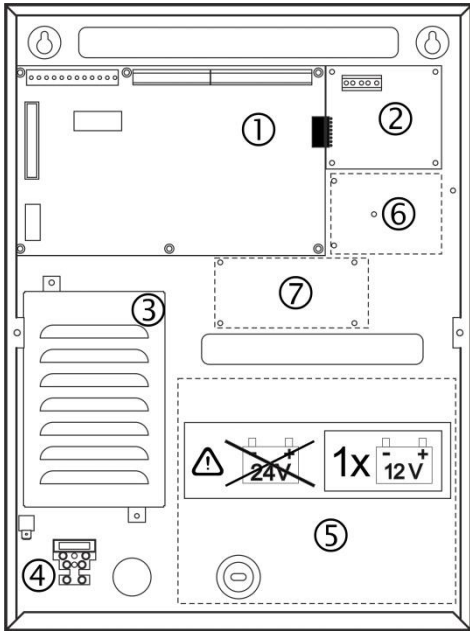

Figure 6 – Configuration of the modules in the box:

- 1 – Main PCB (control panel)
- 2 – Second loop controller (optional, it may not be present in your system configuration)
- 3 – Power supply unit
- 4 – Terminal 230V for connection of the main power supply cable
- 5 – Place for accumulator battery, 1 x 12V/ 18Ah
- 6 – Place for mounting of a communication module
- 7 – Place for mounting of redundant network module

2.2.3 Description of the main PCB (control panel)

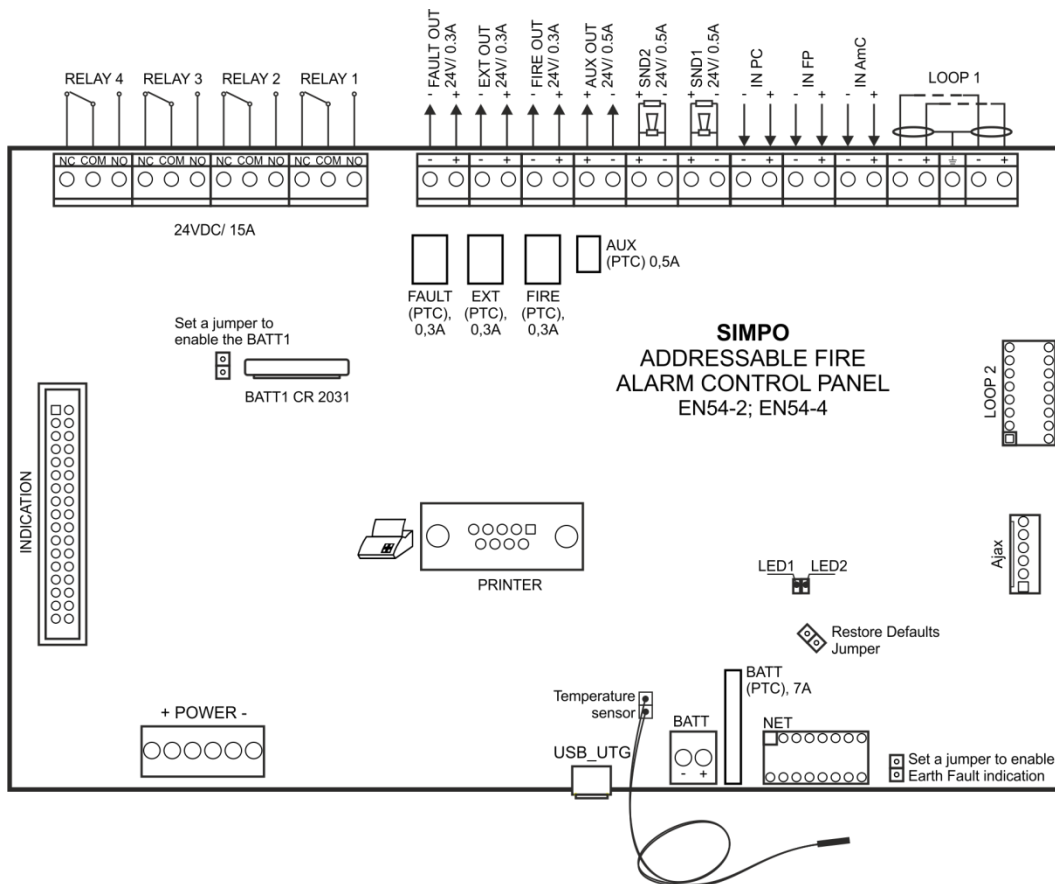

Figure 7 – Main PCB of the SIMPO fire alarm panel

Description of the terminal row (left to right):

- **RELAY 1 - 4** – Programmable volt free change over relay contacts each, 24VDC@15A. Each relay has one NO (normal open) and one NC (normal closed) contact with common lead on a terminal. When a relay output is activated the NO contact is closed and the NC contact is opened.

- **FAULT** – Potential, monitored output for connection of auxiliary devices, 24 VDC/ 0.3A. This output is deactivated in case of system trouble or fault.
- **EXT** - Potential, monitored output for fire extinguishing, 24 VDC/ 0.3A. This output is activated in case of a fire alarm condition.
- **FIRE** – Potential, monitored output for connection of auxiliary devices (signaling devices for example), 24 VDC/ 0.3A. This output is activated in case of fire in the premises.
- **AUX** – Potential output for power supply of auxiliary devices, 24 VDC/ 0.5A.
- **SND 1, SND 2** – Potential, monitored outputs for connecting sounders, 24 VDC/ 0.5A.
- **IN PC (Input Protection Alarm Confirmation)** – Input for monitoring of signal “Confirmation for extinguishing started in the site” sent by extinguishing control panel.
- **IN FP (Input Fault Protection Panel)** – Input for monitoring of signal “Fault” sent by extinguishing control panel.
- **IN AmC (Input Alarm Confirmation)** – Input for monitoring of signal “Alarm confirmation” sent by extinguishing control panel.
- **LOOP 1 (-LOOP+ / +ERT / -LOOP+)** – Terminal row for connecting Loop 1 in the system.
- **LOOP 2** – Interface connector for adding SIMPO TTE loop (for Loop 2) in the system configuration.
- **INDICATION** – Interface connection for the indication module.
- **POWER** – Interface connection for the main power supply unit.
- **JP7** – Jumper for enable/ disable the built-in battery for supporting the real time clock in case of main and backup power supply failure.
- **PRINTER** - RS232 interface connector for heat-printer.
- **USB UTG** – Micro USB A/B connector for firmware update of the main microprocessor via PC or USB flash drive; suitable also for programming via ProsTE software.
- **BATT** – Connector with wires (red and black) for connection to the accumulator battery. The type of connection is according the battery terminals – to every cable shoe is added a separate cable lug connector Ø5mm (M5).
- **Restore Defaults** – Jumper for full hardware reset of the panel and restoring the factory default settings.
- **Earth Fault** – Jumper for enable/disable indication for earth fault.

Example: If you want to enable the earth fault indication set a jumper on Earth Fault terminals.

- **NET** – Interface connector for a redundant network module to the system configuration.
- **Ajax** – Interface connector for adding of a communication module to the system configuration.

Fuses:

- **AUX** – 0.5A, PTC type, resettable
- **FAULT, EXT, FIRE** – 0.3A, PTC type, resettable
- **BATT** – 7A, PTC type, resettable

LED indication:

- **LED 1 (red)** – Indication for scanning the devices connected to Loop1. In normal operation mode the LED lights on continuously in 10 seconds intervals.
- **LED 2 (green)** – Indication for data transfer between the main microprocessor of the panel and the controller for Loop 1. In normal operation mode is constantly blinking.

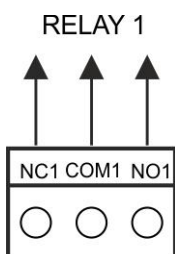

Figure 8 – Internal structure of relay output

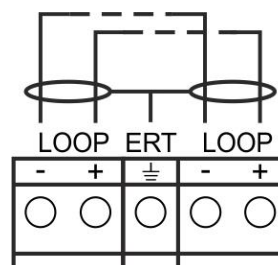

Figure 9 – Connection to the loop controller

Temperature sensor:

The temperature sensor is used for measurement of the battery temperature. The sensor is mounted at the end of the wires couple, factory connected to “Temperature sensor” terminal on the panel’s PCB. The temperature sensor should be placed behind or under the accumulator battery.

2.3. Connection of Signaling Devices



The monitored outputs **SND**, at activation, provide 24VDC@0,5A to the load connected between them and GND*.
 The monitored outputs **FAULT**, **EXT** and **FIRE**, provide 24VDC@0,3A to the load connected between them and GND*.
 It is necessary to connect in parallel to the last device in the loop a 10k terminate resistor, so to ensure that the panel is able to detect any break or short circuit in the loop – see Figures 10 and 11!

* The grounding point of the panel.

2.3.1 Connecting of Sounders

To every monitored output **SND** could be connected several sounders - Figure 10. The maximum number of sounders that could be connected in the circuit depends on their total current consumption, which must not exceed 0,5A. Before connecting the last sounder in the circuit, **parallel to it must be added resistor 10k**.

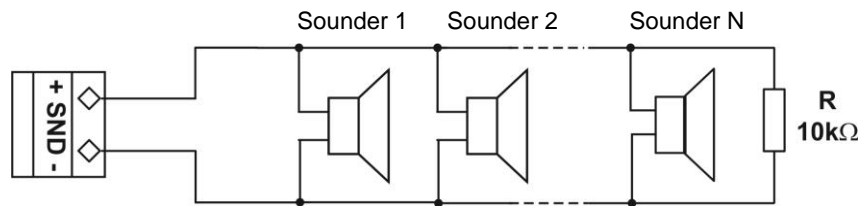

Figure 10 – Connecting sounders to SND output

2.3.2 Connecting of Signaling Devices

To every monitored output **FAULT**, **EXT** and **FIRE** could be connected signaling and other control devices – Figure 11. The maximal consumption of the devices should not exceed 0.3A. Before connecting the last device in the circuit, **parallel to it must be added resistor 10k**.

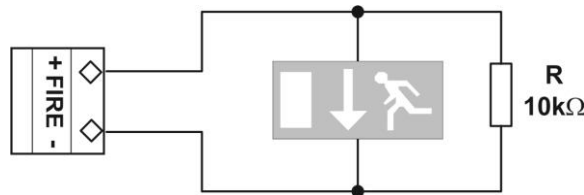
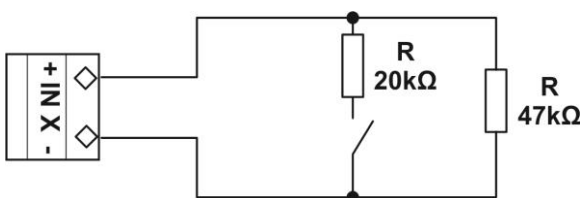

Figure 11 – Example for connecting of end device (an illuminated exit sign) to the Monitored FIRE Output.

2.3.3 Connecting to the Specialized Inputs

The specialized inputs of SIMPO fire alarm panel are designed for operation with an extinguishing control panel. The example connection diagrams are presented on Figures 12 a) and b).



a) Connecting diagram of relay contact to the input

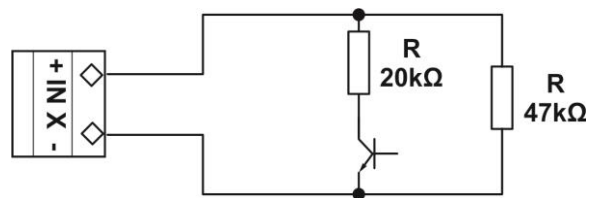

b) Connecting diagram of open collector to the input

Figure 12 – Examples of connections to the specialized input IN XX

2.3.4 Loop Controller

The SIMPO fire alarm panel supports operation with SIMPO TTE loop controller via communication protocol TTE. The Loop Controller realizes the connection between the I/O Module and devices connected to the communication line. The Loop Expander has two basic functions:

- Gathers data from the devices in the communication line and transfers it to the main microcontroller;
- Receives commands from the main microcontroller and transfers them to the devices connected in the communication line.

Up to 250 SensoIRIS devices can be connected to SIMPO TTE loop controller. The general connection diagram of devices to the loop controller is shown on Figure 13.

The maximum current consumption of the devices in the communication line is $I_{max} = 500mA$. If the consumption exceeds this value an over-load protection would be turned on.

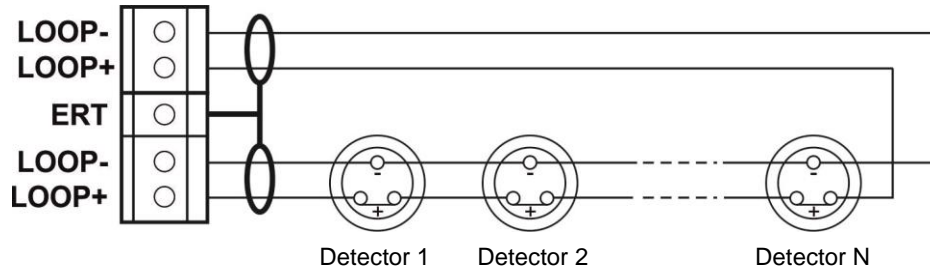
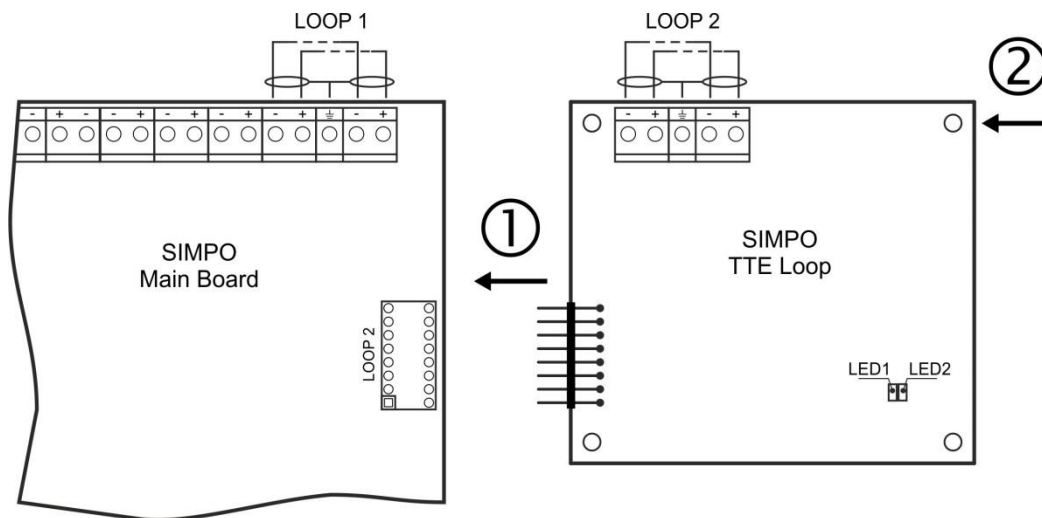

Figure 13 – Connecting of detectors to a loop controller

In the configuration of addressable fire alarm panel SIMPO could be mounted a second loop controller as a separate module – see Figure 14.



ATTENTION! Do not add or remove loop expanders to the fire panel configuration when the main and backup power supplies are on!



- ① - Connect the connectors: LOOP 2 of the main control panel and LOOP of the second loop controller.
- ② - Fix the second loop expander to the metal box of the fire panel using the supplied bolts in the spare parts kit.

LED 1/ LED 2 – LED indication for the loop controller status, analogical to that for the main control panel – see the description on page 12.

Figure 14 – Adding of second loop controller SIMPO TTE Loop

2.3.5 Maximum Permissible Cable Length

The maximum length of the loop in the system could vary according to the cross-section and the ohmic resistance of the used cable.



ATTENTION! SIMPO TTE Loop controller supports up to 250 devices, regardless of the type!

To ensure the correct operation of the system is necessary to make some calculations in advance:

<p>1. To ensure the ability of the fire panel to receive the signals from the devices in the loop, calculate:</p> $L_{C1max} \leq 123 / R_C$	<p>2. To ensure the ability of the fire panel to recognize the double addresses in the system, calculate:</p> $L_{C2max} \leq 62 / R_C$	<p>3. To ensure the ability of the devices in the loop to receive command signals from the panel, calculate:</p> $L_{C3max} \leq (12 / I_{max} - R_i) / R_C$
--	---	--

where:

L_{C1max} , L_{C2max} , L_{C3max} - are maximum permissible length of the used cable, [km];

R_C - is total ohm resistance of the two wires of the used cable; its value shows the magnitude of the cable resistance at length 1km [Ω /km];

R_i - is the total resistance of the isolator modules in the loop;

I_{max} - is the maximum current consumption in the loop in alarm condition - total amount of the current consumption of all devices in alarm state* in the loop.

**Note: In case of using more than 15 devices SensolRIS series from type MC-D, T110/ T110 IS, S130/ S130IS, M140/ M140IS, MCP150, MCP150 IP67 and MC-Z, in calculation of I_{max} value is used the maximum current consumption in alarm state* only for those 15 devices with the highest consumption, and for the rest devices is used the consumption in stand-by mode*.*

** For the max. current consumption in alarm state and the consumption in quiescent state with communication (stand-by mode) of a device refer to its installation manual.*

L_C - is the necessary length of the cable for the loop.

After calculating, the maximal length of the cable is determined according:

- If $L_C \leq L_{C2max}$ and $L_C \leq L_{C3max}$ - the fire pane will be able to communicate with the devices in the loop and also will be able to identify the presence of double addresses.
- If $L_{C2max} < L_C \leq L_{C1max}$ and $L_C \leq L_{C3max}$ - the fire panel will be able to communicate with the devices in the loop but will not be able to identify the presence of double addresses.



**ATTENTION! Always calculate the maximal cable length according the mentioned above formulas!
If $L_C > L_{C1max}$ or $L_C > L_{C3max}$ - the fire panel would not be able to communicate with the devices.**

The connection diagram shown on Figure 15, gives the possibility to protect devices against opening and short circuit. For example, short-circuit in section 2 will not influence the operation of sections 1 and 3. The isolator modules at the both ends of section 2 will isolate it, and section 1 and 3 will continue working properly, as section 1 will operate by supply from the channel "A" and section 3 - by supply from channel "B". Since the fire panel will not be able to communicate with the devices from section 2, it will generate an alarm signal for lost devices and open circuit.



The maximum recommended number of devices between two isolator modules (module isolator device or using the built-in module isolator in a device) is 30!

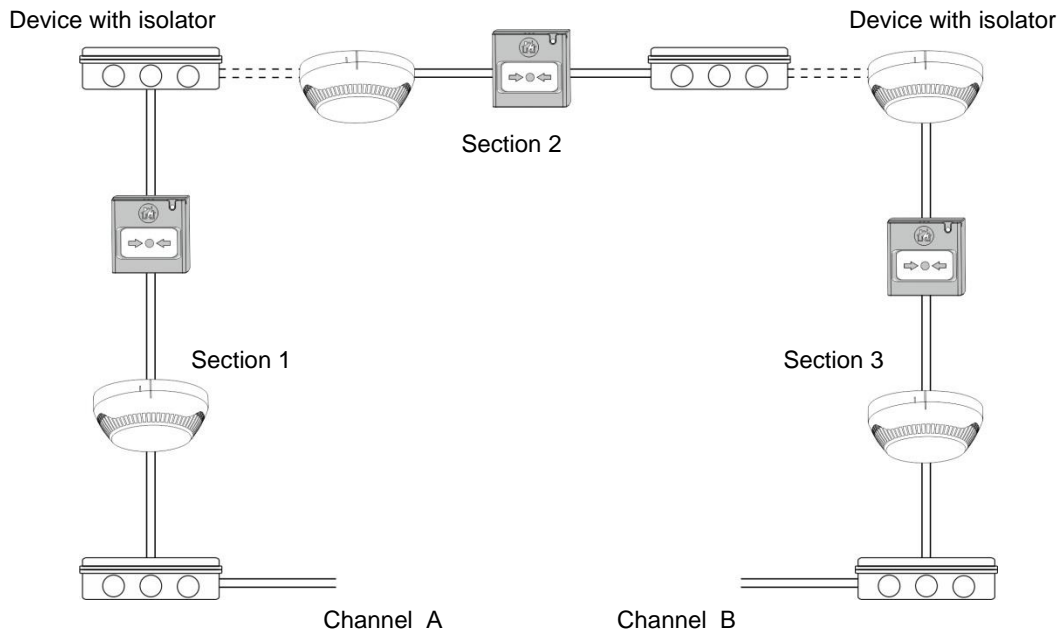

Figure 15 – Example for connecting of detectors and call points to a loop expander (the built-in in the main control panel or SIMPO TTE Loop)

2.4. Connecting to the Main Power Source

The mains power supply of SIMPO fire alarm panel is realized with connection of the main power cable to the 230V terminal, mounted in the metal box under the powers source. The connection between the 230V terminal and the main power source is done from the manufacturer. The connection of the main power supply cable to the 230V terminal is shown on Figure 16.

Before the mains supply is switched on, check the correct connection of each loop, sounder or any other input or output!

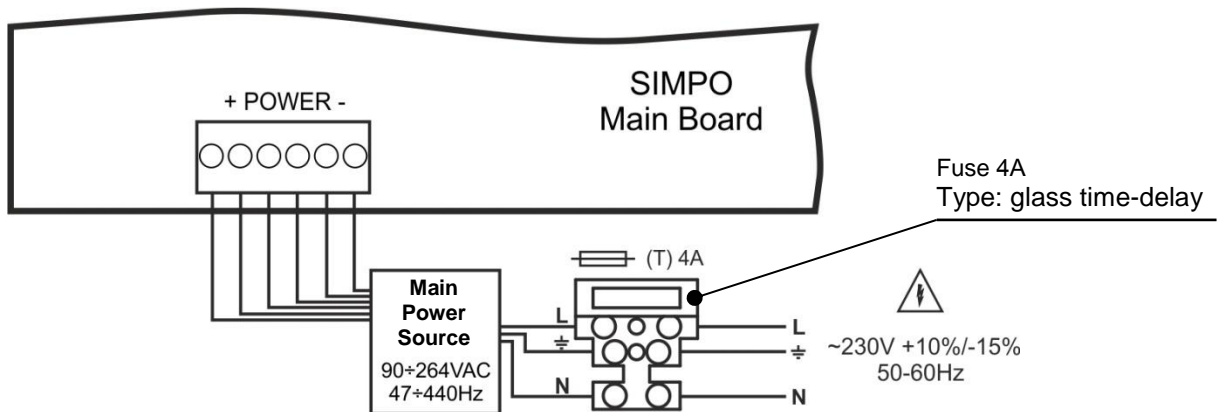

Figure 16. Connecting the main power supply cable to the 230V terminal

2.5. Connecting the Accumulator Battery

The accumulator battery leads are mounted on a terminal at the bottom of main control panel. Connect the battery leads to the accumulator terminal as observe the polarity - see Figure 17.



**The battery cannot power up the panel before the mains supply has been switched on!
The charging of the accumulator battery is done at maximum current $I = 2A$ and charging voltage $U \leq 13.65V$.**

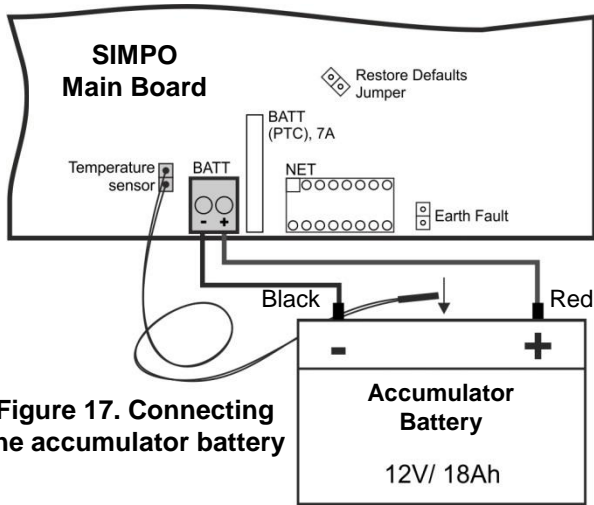

Figure 17. Connecting the accumulator battery



Attention: The connection between the accumulator battery and the main power source has some special features. It is strongly recommended to use only battery with electrical characteristics and dimensions pointed from the manufacturer. Before connecting to the power source check the polarity of the battery. Connect the battery after the mains supply is turned on. If the battery is new it will take a few hours before its complete charging! To measure the current temperature of the battery, place the temperature sensor behind or under the battery.

2.6. Connecting a Heat Printer

The addressable fire alarm panel SIMPO is equipped with RS232 interface connector, situated in the middle of the main PCB, for connecting a heat printer. The heat printer allows the technician to print the log file for the alarm and fault events, warnings and changes during programming. The capacity of log file is 10000 events, which are saved with date and time of occurring – see also item 7.1.4.

The addressable fire alarm panel SIMPO supports Canon 9 type external printers, models Kafka and Datecs. For connecting the SIMPO panel to the heat printer you have to prepare a special cable for the purpose – connect two male DB9-DB9 (Datecs printer) or DB9-DIN5 (Kafka printer) type connectors as shown on Figure 18.

Before printing (access levels 2 and 3) make sure that the heat printer is connected to the 'PRINTER' interface connector on the main PCB and the printer is powered on.

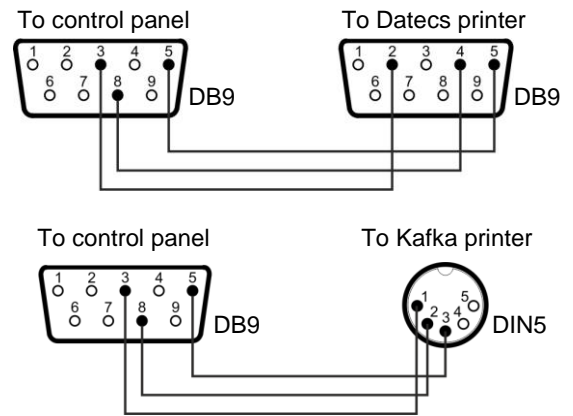

Figure 18

2.7. Connecting a Network Module (supported for Soft. Revision 2.8 and higher)

The addressable fire alarm panel SIMPO is designed with option for connection in a Ethernet network with other SIMPO or IRIS addressable panels (up to 32). The network module is mounted under the main PCB and is connected to 'NET' connector – Figure 19. The module should be fixed with screws to the metal bottom. The maximum cable length between two redundant network modules is 1000m.



Attention: NEVER add or remove the network module to the fire panel configuration WHEN THE MAIN AND BACKUP POWER SUPPLIES ARE ON!

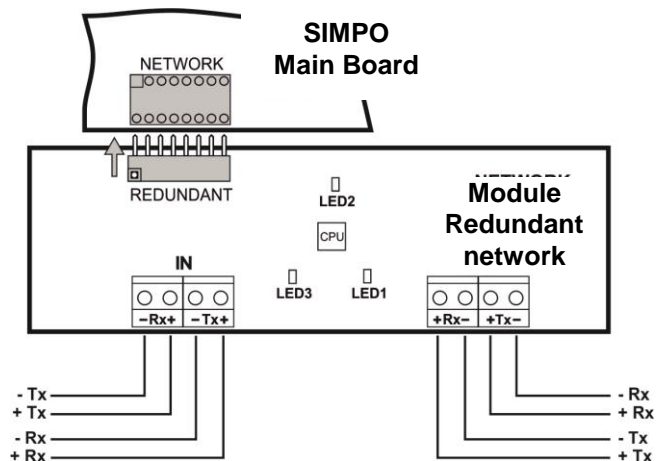

Figure 19

3. PROGRAMMING TYPES

3.1. Programming via ProsTE Software

The specialized ProsTE software is designed for programming of intruder and fire alarm panels produced by Teletek Electronics JSC. To program the fire alarm panel SIMPO you should first to install the ProsTE software on your computer – the program can be downloaded free of charge after registration on the website of the producer:

<http://www.teletek-electronics.com/en/product/proste-en>

To program the SIMPO panel you have to use cable type USB Micro B - USB A – Figure 20.

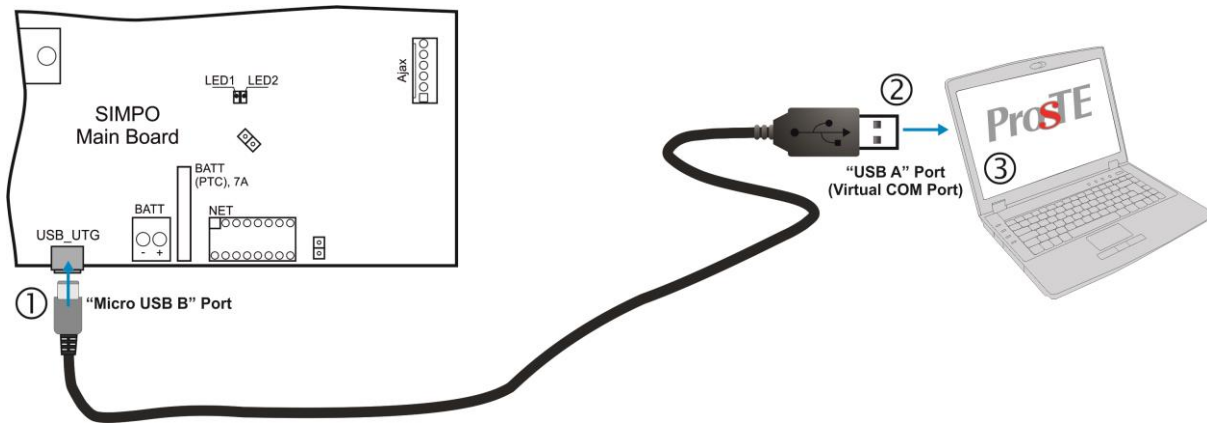

Figure 20. Programming via ProsTE software

3.2. Programming via Panel's Keyboard

The addressable fire alarm panel SIMPO can be programmed directly using the keyboard on the front panel. The programming and settings are accessed from levels 2 (Maintenance) and 3 (Installer). The buttons on the front panel are organized in three main groups

- Functional digit buttons – used for entry in submenus, changing parameter status, entering of new combination for Maintenance and Installer access codes.
- Navigation buttons – arrows for moving the cursor on the screen and switching over the editable fields, confirmation of entered parameters, cancelation of entered parameters and step back in the menu programming structure.
- Specialized buttons for User operation – Silence buzzer, Silence sounders, Reset, Evacuation, General test of the LEDs, buzzer and screen.

The detailed description of all buttons on the front panel is presented in item 2.2.1 – 5, page. 9

The detailed description of Maintenance and Installer programming access levels is presented in item 5.

3.3. Firmware Update

ATTENTION!
The firmware update of the main microprocessor of fire alarm panel SIMPO should be performed by qualified personnel only and after held training program by the producer Teletek Electronics JSC!

3.3.1 Firmware Update from Computer

To start a firmware update from a computer you should first to have a copy of an image update file (with *.bin extension) saved on your computer. For firmware updates use the USB_UTG connector on the main PCB:

- Connect the panel to the computer using USB cable: Normal A to Micro B type.
- Enter access code for level 2 or 3 and choose menu **9) SOFT. REVISION.**
- Wait for the message from *Windows Explorer* for found new *Removable Disk*.
- The panel will display automatically on the screen:

```

USB Host Detected
1. Copy image file to Removable Disk
2. Make Eject at Removable Disk
> Panel is configured
    
```

- Use the *Windows Explorer* file manager to copy the new image update file (with *.bin extension) in *Removable Disk* directory.
- When the copying of the image file completes, remove the *Removable Disk*, as select *Eject* option from its dialogue box (right click with the mouse over it).
- If the data in the image file are correct, the panel starts the firmware update procedure of the main microprocessor accompanied with short beeps.
- Disconnect the USB cable.
- The panel will reset itself automatically after a successful firmware update.

3.3.2 Firmware Update from USB Drive

To start a firmware update from a USB drive you should first have to copy the new image update file (with *.bin extension) in the main directory of the USB removable disk. The name of the file must be short – up to 8 symbols.

- Connect the panel to the computer using USB cable: USB Micro A - USB A type.
- Enter access code for level 2 or 3 and choose menu **9) SOFT. REVISION.**
- Connect the USB drive, with the new image file (with *.bin extension).

Notes:

1. The panel will scan the files copied only in the main directory and these files in the first subfolders in the tree hierarchy of the USB drive.
2. It is obligatory the name of the file to be up to 8 symbols long.

- Wait until the polling procedure is complete - USB drive will be displayed with its name and manufacturer. On the last row of the screen will start blinking the notice **Push 'Enter' to continue.**
- Press *Enter* button and wait for a message for the USB drive capacity. On the last row of the screen will be active two buttons **(2) To Panel** and **(3) From Panel.**
- Press **(2) To Panel** button. A list with the present image files (with *.bin extension) copied to USB drive is displayed on the screen, as the software revision is displayed on the right side, for example:

```
0:/SIMPO/SIMPO2_0.BIN      v 2.00
```

- Scroll through the listed files using the buttons with up and down arrows – the currently selected file is blinking.
- Select the file and press *Enter* button.
- The panel starts uploading the file from the USB drive to the external Flash memory of the panel. The running process is displayed with a progress bar.
- If the data in the image file are correct, the panel starts the firmware update procedure of the main microprocessor accompanied with short beeps.
- Disconnect the USB cable.
- The panel will reset itself automatically after a successful firmware update.

3.3.3 Copying Image File from the Panel to USB Drive

- Connect the panel to the computer using USB cable: USB Micro B - USB A type.
- Enter access code for level 2 or 3 and choose menu **9) SOFT. REVISION.**
- Connect the USB drive.
- Wait until the polling procedure is complete - USB drive will be displayed with its name and manufacturer. On the last row of the screen will start blinking the notice **Push 'Enter' to continue.**
- Press *Enter* button and wait for a message for the USB drive capacity. On the last row of the screen will be active two buttons **(2) To Panel** and **(3) From Panel.**
- Press **(3) From Panel** button – the panel will download a copy of its own image file to the USB drive and saves the file in SIMPO folder.

4. FULL HARDWARE RESET

The full hardware reset of SIMPO addressable fire alarm panel allows the engineer to restore all factory settings and access code combinations for level 2 (Maintenance) and 3 (Installer).

To perform full hardware reset, follow the steps:

1. Disconnect the mains and backup power supplies.
2. Set a jumper on 'RESTORE DEFAULTS' terminal on the PCB.
3. Connect mains and after that the backup power supply.
4. Wait the procedure for initialization to complete.
5. Remove the jumper from 'RESTORE DEFAULTS' terminal.
6. Proceed with save system configuration and other settings.

5. PROGRAMMING OF SIMPO FIRE ALARM PANEL

5.1. General Information for Programming and Operation

Addressable fire alarm panel SIMPO can be programmed directly through the navigation and functional digit buttons on the front panel. The programming menus are organized in a text tree-structure and are viewed on the LCD-display (4 rows x 40 symbols). The access to the programming menus is organized in three levels – see items 5.2.

When turned on, the panel always conducts a procedure of loading the parameters, which usually takes about 5-6 sec. There is no access to the menus of the panel during that procedure.

Upon the initial startup, the panel does not hold any configurations. Initialization may take several minutes. The initialization time needed depends on the number of periphery and loop devices – for Loop 1 and Loop 2. After the panel has been turned on, it performs a procedure for detecting newly installed loop devices – see also APPENDIX C, page 48.

During the procedure the symbol “*” is blinking in the up right corner of the screen. This symbol will appear always when running similar procedures like resetting of devices or recognized new devices connected to the loop. Right after the initial startup of the mains power supply and initialization completed the panel turns to normal operation mode. If there are any active alarm and fault messages they are displayed on the screen, as the indication follows the priority:

Indication - Groups	Priority
ALARMS	The highest
FAULTS	High
DISABLED	Normal
TESTS	Normal
WARNINGS	Low

The name of the current active indication group is blinking together with the number of the first message. Press the ENTER button to review some additional information for the respective message as data and time of occurring, device address, zone number or other, according the trouble type.

The indication for the active ALARMS in the system is viewed with highest priority.

The addressable fire alarm panel SIMPO supports different languages for the programming menus.

The factory default setting of the language is in English. You can change the language after the initial power-up as enter in sequence:

Press CANCEL – enter code 3333 – select menu 6) GENERAL SETTINGS – menu 6.4) PANEL SETTINGS – Button 1 – Button ENTER



Use the ENTER button to enter in programming menus and confirmation of entered values and parameters; the functional digit buttons are used for entering of access codes and changing the current status; the navigation buttons (up/ down and left/ right arrows) are used for scrolling through the menus and for changing the editing field.

5.2. Codes and Access Levels

There are three access levels in SIMPO panel: User, Maintenance and Installer. Every level comprises different functions and operations. To enter Maintenance and Installer levels is necessary to enter valid access code:

Level	Description	Code Combination	Access
1	User	-	Only Silence buzzer and Evacuation* buttons are active. It is not allowed to enter Maintenance and Programming access levels. * Just for that cases, when the fire alarm signal is received from a device
2	Maintenance	2222	Silence buzzer, Silence sounders, Reset and Evacuation buttons are active. Maintenance access level entry, which allows partial programming and menu settings.
3	Installer	3333	Silence buzzer, Silence sounders, Reset and Evacuation buttons are active. Installer access level entry, which allows full programming and settings.

The introduced code combinations are visualized with “*” symbol. The entry is automatic.

The access codes could be changed only from level Installer - menu 6) General Settings - submenu 6.1) Access codes. There are different restrictions on the panel functions in the relative access levels, which are shown in the following table:

	Mode/ Menu	Description	Access Level		
			1	2	3
Operation modes	ALARMS	Viewing the Alarms Messages in the system.	✓	×	×
	FAULTS	Viewing the Faults Messages in the system.	✓	×	×
	DISABLED	Viewing the active disablements in the system.	✓	×	×
	TESTS	Viewing the running tests in the system.	✓	×	×
	WARNINGS	Viewing the Warnings Messages in the system.	✓	×	×
	Silence buzzer	Deactivating Internal Buzzer.	✓	✓	✓
	Silence Sounders	Deactivating the Sounders. During active fire alarms and deactivated/ silenced sounders the LED next the button is lighting up.	×	✓	✓
	Reset	Resetting the panel without switching off the main and backup power supplies.	×	✓	✓
	Evacuation	Activating Evacuation alarm signal; the sounders will activate immediately overriding all introduced delays.	✓*	✓	✓
	Test	General test for operability of all LEDs and internal buzzer.	✓	✓	✓
Programming menus	View history LOG	Viewing the LOG file for all events; printing of all or separate events; clear the log file.	×	✓	✓
	Zones	Zones status; setting a zone name; parameter programming; zone test for operability.	×	✓	✓
	Devices Setup	Setting a device name; parameter programming.	×	✓	✓
	Addressing:	Menus for addressing devices.	-		
	• Set address	Setting an address for single devices.	×	×	✓
	• Change address	Changing device address.	×	×	✓
	• Self-addressing	Automatic self-addressing mode.	×	×	✓
	• Autoaddressing	Automatic mode for addressing devices by ID or isolator.	×	×	✓
	Panel outputs	Parameter programming for the built-in panel outputs: SOUNDERS, EXITING, FIRE, FAULT, RELAY OUTPUTS.	×	✓	✓
	General Settings:	General settings common for the panel.	-		
	• Access codes	Changing the code combinations for levels Maintenance and Installer; enable/ disable the automatic exit from the installer programming menus.	×	×	✓
	• Time/ Day	Setting the current time and date.	×	×	✓
	• Day/ Night alarm mode	Setting Day/ Night alarm mode or operation on schedule.	×	✓	✓
	• Panel settings	Changing the menu language, setting the backlight brightness; entering disablements.	×	✓	✓
	• Delay T1	Setting the Delay T1.	×	✓	✓
	• Sounders mode	Programming the operation of SOUNDER outputs.	×	✓	✓
	• Company logo	Enter company information for the main screen	×	✓	✓
	Save configuration	Saving the set system configuration.	×	×	✓
	Restore defaults	Restoring the factory default settings.	×	×	✓
	Software revision	Reviewing the current software revision.	×	✓	✓
Network	Setting the redundant network parameters	×	×	✓	
Active isolators	Reviewing the activated isolators in the system.	×	✓	✓	
Access level 1	Return to Access Level 1.	×	✓	✓	

* Just for those cases, when the fire alarm signal is received from a device.

× - The operation modes and the menus are not supported for that access level

✓ - The operation modes and the menus can be reviewed or are allowed for partial programming for that access level

6. DESCRIPTION OF THE OPERATION MODES

In this section you can find detailed descriptions of all operation modes of SIMPO addressable fire alarm panel. The modes for reviewing of system events are accessible only from level 1 without entering access code. If no alarm, fault or warning messages, active tests and disablements are present, then the panel is in normal operation mode and only the current day and time is displayed. In case of alarm, fault or warning situation is occurred the panel will display information and text messages for the events. A list of all types of event messages is presented with details in APPENDIX A.

6.1. Review of Alarm Events

The messages for alarm events are displayed with the highest priority in the system. In case of alarm in the system the panel will show a list with active alarms at the moment, and ALARMS mode is blinking together with the number of the first alarm message. Over the button (1) is displayed the total number of the active alarms. The LED 'General Fire' lights on together with the number of the zone in alarm. The panel is signaling with continuous sound signal, which can be stopped with pressing the 'Silence buzzer' button. The activated sounders could be stopped after entering access level 2 or 3 and pressing the 'Silence sounders' button.

Example:

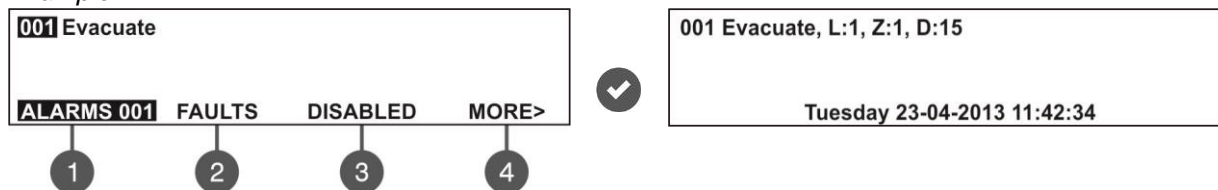

The User can review also some additional information for every of the alarm events. For this, select the number of the alarm message using up/ down arrow buttons (the number of the selected event is blinking) and press ENTER button. On the screen is displayed information for the loop number and the address of the device sensed the alarm event. At the bottom of the screen is displayed the day and time of occurring of the respective event. Note that the additional information is different according the type of the alarm event. To exit the review alarm events mode, press CANCEL button.

6.2. Review of Fault Events

The messages for fault events are displayed with high priority. If no alarm events are present, and there are active faults in the system, the FAULTS mode is blinking together with the number of the first fault event. The LED 'General Fault' lights on. The faults messages are cleared automatically after the fault condition is restored.

Example:

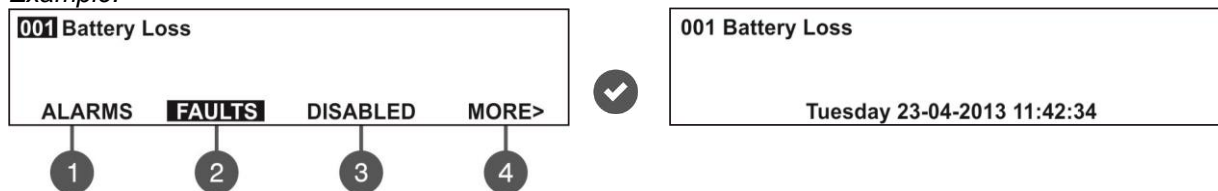

The User can review also some additional information for every of the faults events. For this, select the number of the fault message using up/ down arrow buttons (the number of the selected event is blinking) and press ENTER button. In case, there are active alarms in the system, but you want to review the fault messages, press button (2) – FAULTS mode. The present faults in the system are displayed with serial numbers. The reviewing is the same as described in item 6.1. The total number of active faults is displayed at the bottom right corner of the screen. Use button (1) to go back to ALARMS mode and reviewing the alarm messages.

To review the FAULTS at active alarms in the system:

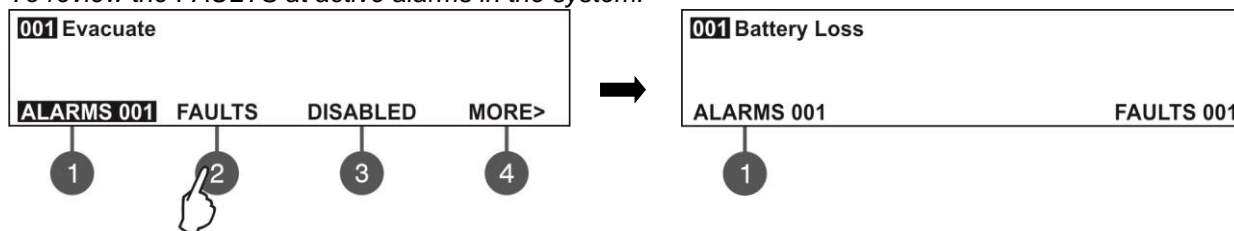

To exit the review fault events mode, press CANCEL button.

6.3. Review of Disablements

The messages for disablements are displayed with normal priority. If no alarm or fault events are present, and there are active disablements in the system, the DISABLED mode is blinking together with the number of the first disablement. The LED 'Disable' is lighting on.

Example:

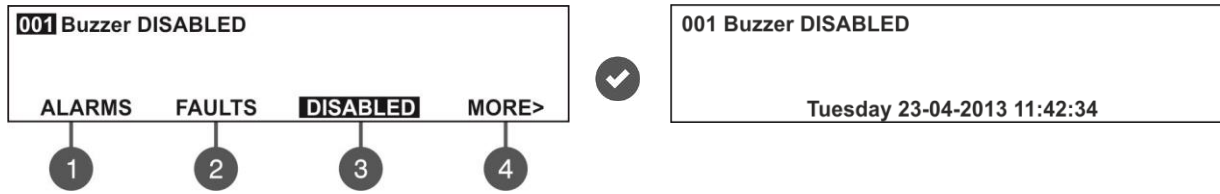

The User can review also some additional information for each of the disablements. For this, select the number of the disablement message using up/ down arrow buttons (the number of the selected event is blinking) and press ENTER button.

In case, there are active alarms and/ or faults in the system, but you want to review the disablements, press button (3) – DISABLED mode. The disablements in the system are displayed with serial numbers. The reviewing is the same as described in item 6.1. The total number of the introduced disablements is displayed at the bottom right corner of the screen. Use button (1) to go back to ALARMS mode and reviewing the alarm messages.

To review the DISABLED at active alarms and/ or faults in the system:

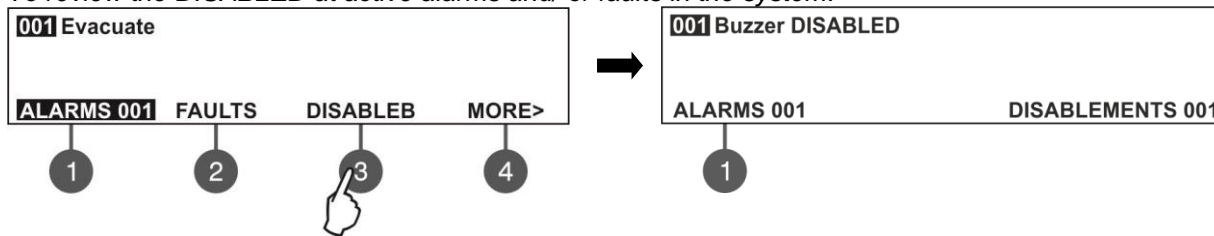

To exit the review fault events mode, press CANCEL button.

6.4. Review of Running Tests

The messages for running tests are displayed with normal priority. If no alarm or fault events or disablements are present, and there are active tests in the system, the TESTS mode is blinking together with the number of the first running test. The LED 'Test' is lighting on.

The numbers of the zones in test mode with activated detectors are blinking.

Example:

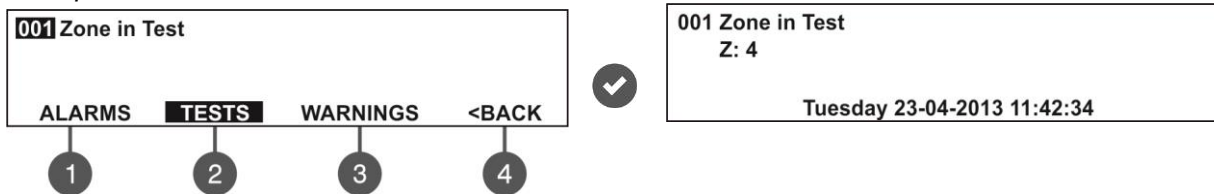

The User can review the number of the zone in test mode. For this, select the number of the zone using up/ down arrow buttons (the number of the selected event is blinking) and press ENTER button.

If, there are active alarms and/ or faults in the system and you want to review the running tests, press button (4) MORE>> – TESTS mode is blinking. The tests running in the system are displayed with serial numbers. The reviewing is the same as described in item 6.1. The total number of the running tests is displayed at the bottom right corner of the screen. Use button (1) to go back to ALARMS mode and reviewing the alarm messages.

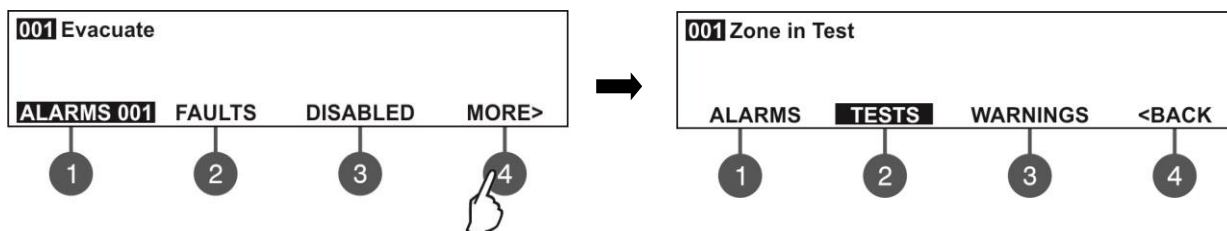

After choosing the button (2) TESTS the screen displays:

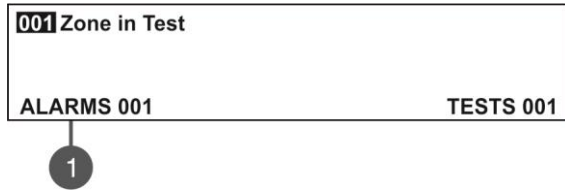

To exit the review of running tests mode, press CANCEL button.

6.5. Review of Warning Messages

The messages for warnings are displayed with low priority. If no alarm or fault events or disablements and tests are present, and there are active warnings in the system, the WARNINGS mode is blinking together with the number of the first message. There is no LED indication on the front panel.

Example:

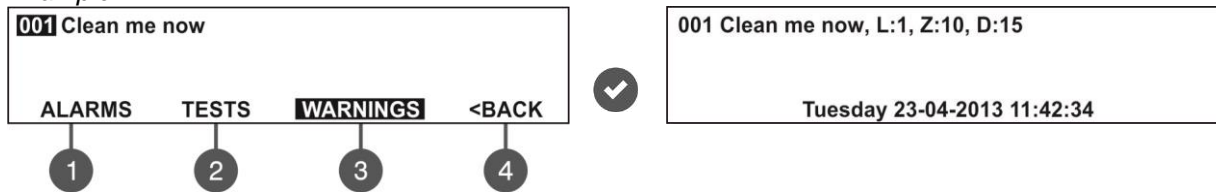

The User can review also some additional information for every warning message. For this, select the number of the message using up/ down arrow buttons (the number of the selected event is blinking) and press ENTER button. On the screen is displayed information for the loop number (L:), zone number (Z:) and the address and name of the device (D:)*. At the bottom of the screen is displayed the date and time of occurring of the warning. Note that the additional information is different according to the type of the warning event.

* **NOTE:** If the device is an input-output module the number of activated input/output is displayed after the address. For example, the screen displays message: "Loop Device Input Active - L:1; Z:1; D:3.1", where after the address of the device is displayed and the number of the activated input of the module. In the example the address of the module is 3 and the number of activated input is 1. The name of the input will be displayed at the end of the message – see 7.3.6.

In case, there are active alarms and/ or faults in the system, but you want to review the warnings, press button (4) MORE>> – (3) WARNING mode. The warning messages in the system are displayed with serial numbers. The reviewing is the same as described in item 6.1. The total number of the warnings is displayed at the bottom right corner of the screen. Use button (1) to go back to ALARMS mode and reviewing the alarm messages.

To review the WARNINGS at active alarms and/ or faults in the system:

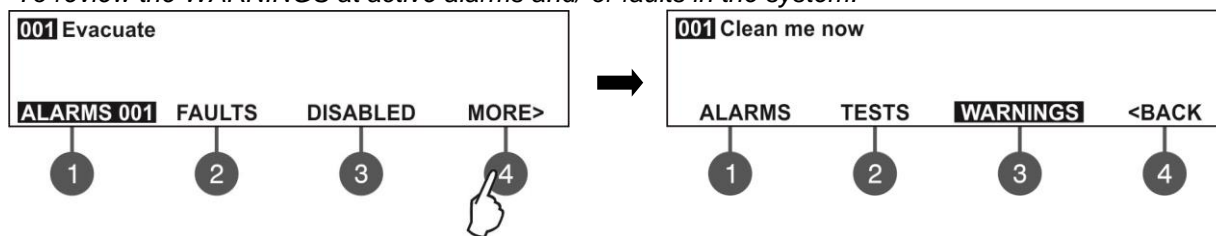

After choosing the button (3) WARNINGS the screen displays:

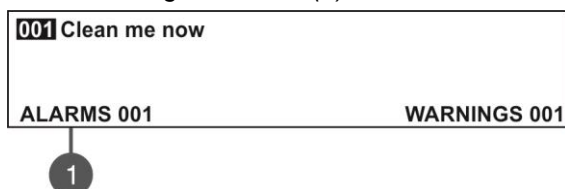

To exit the review warning messages mode, press CANCEL button.

NOTE: If you are programming parameters at Access Level 2 (Maintenance) or Access Level 3 (Installer) and there is an alarm or fault event in the system, the panel will automatically display a list with messages. After reviewing the events, you can return to the programming mode with single pressing the CANCEL button.

6.6. Silencing the Internal Buzzer

The internal buzzer of addressable fire alarm panel SIMPO is signaling in case of activated alarm or fault events in the system. The buzzer silencing is available from every access level without code entry.

To silence the internal buzzer press  button.

6.7. Silencing the Sounders

The sounders silencing is available from access levels 2 and 3 after code entry.

To silence the sounders enter in sequence:

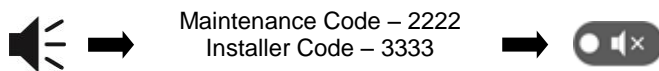

The LED 'Silence sounders' right to the button is lighting up.

To reset the panel in normal operation mode press 'Reset' button.

6.8. Activate Evacuation

The evacuation alert is available for activation from every access level regarding the following:

- **Level 1:** Just for that cases, **when the fire alarm signal is received from a detector in a zone.**
To start the sounders for evacuation alert, the user has to press  the button.
- **Levels 2 and 3:** In case there is **no fire alarm signal from a detector in a zone.**
To start the sounders for evacuation alert, the user has to enter in sequence:

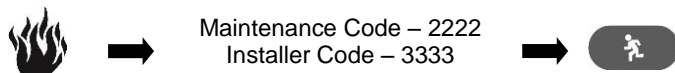

6.9. Resetting the Panel

The resetting of the panel's current state is available from access levels 2 and 3 after code entry. The resetting function is used for initializing the panel and return to normal operation mode after alarm or fault restoring.

To reset the panel enter in sequence:

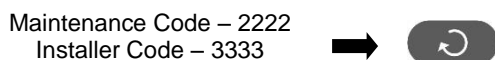

After resetting are cleared also all introduced earlier test in zones and disablements. The introduced delays are not cleared. The panel returns to normal operation mode.

6.10. Indication Test

The indication test could be started at any time regardless of the access level. The general test allows the user to review the correct operation of the LED indication on the front panel, the sound signal of the internal buzzer, and the visualization on the LCD display.

To start the general test press  button – all LEDs must light on and the internal buzzer starts sounding. On the LCD module every one position is displayed with 5x8 dots. The panel will automatically exit the general test mode after 6 seconds. The general test can be stopped also with next pressing of the same button.

7. DESCRIPTION OF THE PROGRAMMING MENUS

The programming menus are accessible from level 2 (Maintenance) and level 3 (Installer) after entering a valid access code.

In level 2 could be realized partial programming of parameters, and some values are accessible only for reviewing. In level 3 could be realized full programming and settings, and also to restore the factory default settings, including access codes. For details see the descriptions in the tables in item 5.2 for the rights and limitations for every access level.

The navigation buttons have the following functionalities in operation:

Button	Functions
	Menu entry; Confirmation of entered parameters and settings.
	Cancelation of entered parameters and settings; Step back in the menu structure.
	Scrolling between menus; Increasing values; Text entering.
	Scrolling between menus; Decreasing values; Text entering.
	Changing the editing fields.

7.1. View History Log Menu

This menu allows the installer to review and print the system events recorded in the panel memory log file. The capacity of the panel memory log file is 10000 events. The installer can clear also all panel's memory or to extract a list of events by date. The menus are accessible from levels 2 and 3.

After entering the menu the screen displays:

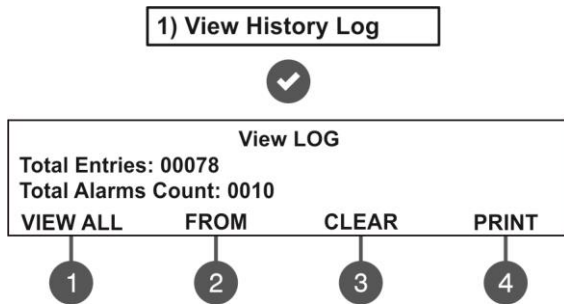

The following general information is displayed in the main screen of VIEW LOG menu:

Total Entries - Shows the total number of the recorded events in the memory log file.

Total Alarms Count - Shows the total number of the registered alarm events.

Use the functional digit buttons to enter the respective submenu.

7.1.1 Review of Full Events List

From the main screen of VIEW LOG menu press **(1) VIEW ALL** button. The last (newest) event is displayed on the screen. Use the buttons with up and down arrows to review all recorded events one-by-one, as everyone is displayed with date and time of occurring.

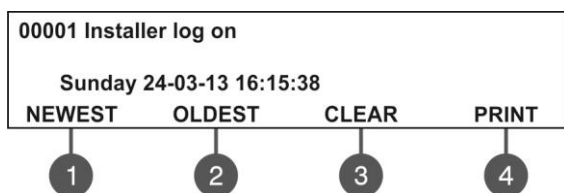

Press a functional button for entry in the respective submenu:

1 - NEWEST. Shows the last recorded event.

2 - OLDEST. Shows the first recorded event.

3 - CLEAR. See the description of item 7.1.3

4 - PRINT. See the description of 7.1.4

Exit to the main screen of VIEW LOG menu is realized with CANCEL button.

7.1.2 Review of List of Events by Date

From the main screen of VIEW LOG menu press **(2) FROM** button. In “FROM” submenu the installer can extract a list of events by date. Set in sequence the day, the month and the last two digits of the year. The edited digit is flashing. Scroll between the fields using the left and the right arrows.

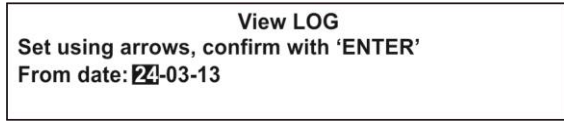

In “From date” field enter the new date using the buttons:
 - **UP arrow** for increasing the number
 - **DOWN arrow** for decreasing the number
 - **LEFT/ RIGHT arrows** for changing the editing field

Then press the ENTER button – at the screen is displayed the first event for the entered date with time. Exit to the main screen of VIEW LOG menu is realized with CANCEL button.

7.1.3 Deleting the Events in the LOG file

From the main screen of VIEW LOG menu press **(3) CLEAR** button. In “CLEAR”* menu the installer can delete the entire system events list. The screen displays the total number of recorded events.

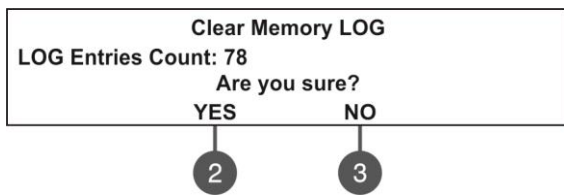

The system will ask for confirmation. To delete all records in the LOG file press **(2) YES** button.

Exit to the main screen of VIEW LOG menu is realized with CANCEL or (3) NO button.

Note: The ‘CLEAR’ submenu is not available in the Maintenance access level (2).

7.1.4 Printing Events

Attention: To print the system events you have to connect printer to the ‘PRINTER’ terminal on the main board. Check your printer connection before entering this menu! Use only printer models recommended from the manufacturer!

From the main screen of VIEW LOG menu press **(4) PRINT** button. The screen displays two fields for setting a time interval for the extract. Two additional submenus for printer settings are available also.

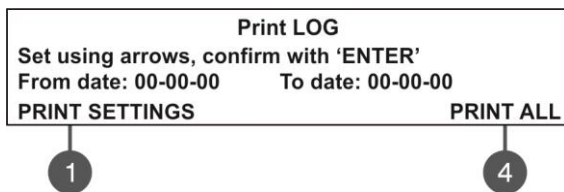

In the fields “From date” and “To date” enter the time interval for printing. You can use also the functional digit buttons to select:
1 – PRINT SETTINGS. Press to enter in submenu for printer settings – see also item 1.1.5.
4 – PRINT ALL. Press for direct printing of all recorded events in the system LOG file.

Press the ENTER button to start printing. The system will ask for confirmation before starting the printing.

7.1.5 Printer Settings

From the main screen of PRINT LOG menu press **(1) PRINT SETTINGS**. The screen displays the available printer settings.

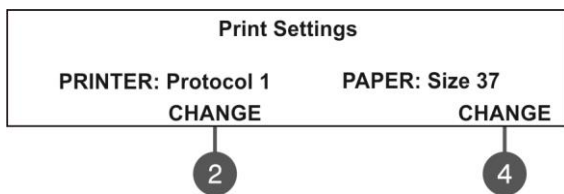

Use the respective functional buttons to change the settings of the respective submenu.
2 – Press the button to change the used printing protocol:
 Protocol 1: Kafka printer
 Protocol 2: Datecs printer

4 – Press the button to change the size of the used paper. The possible size formats are: 37/ 57/ 80 mm.

Confirm all changes with pressing ENTER button. Exit to the main screen of VIEW LOG menu is realized with CANCEL button.

7.2. Zones Menu

This menu allows the installer to review and change the status of every zone. In the 'ZONES' menus the installer can test and enable/ disable the zones. Up to 48 zone numbers are available for settings. The currently edited zone number is blinking. The menu is accessible from levels 2 and 3.

After entering the menu the screen displays:

The screen displays the current status of every zone with its name (if entered). The editable zone number is blinking.

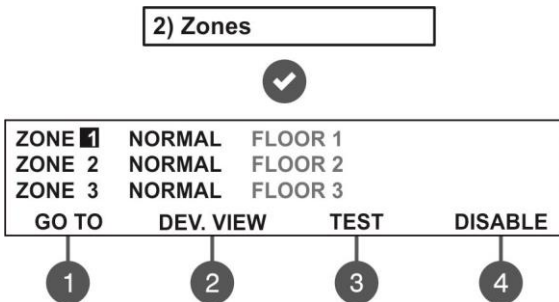

Description of the zone status:

- **NORMAL** – The zone is in normal operation state.
- **DISABLED** – The zone is disabled. See item 7.2.3.
- **TEST** – The zone is in test mode. See item 7.2.2.
- **FIRE** – A device in the zone is in fire.
- **PRE ALARM** – The zone is in preliminary alarm mode. See the description for '2DEVICES' and 'DOUBLE' action modes - item 7.2.6.
- **FAULT** – Trouble in the zone – lost device, broken circuit, etc.

7.2.1 General Submenus

From the main screen of ZONES menu use the functional digit buttons for direct entry to: (1) GO TO and (2) DEV. VIEW submenus.

- **Submenu (1) GO TO.** Enter the zone number you want to go. After pressing the button the screen displays:

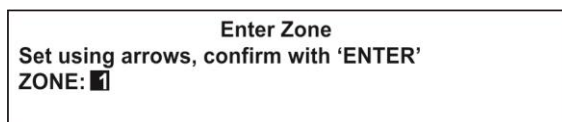

Use up and down arrows to select zone number. Confirm with 'ENTER' button. The system will automatically go back to the main screen of ZONES menu as the number of the zone is blinking.

- **Submenu (2) DEV. VIEW.** The submenu shows information about the total number of the devices in the respective zone. From the main screen of ZONES menu, select a zone number and press button (2). A detailed list with address and name of the respective devices is displayed also. The screen displays information about the total number of the devices in the selected zone regardless of their current state.

Example:

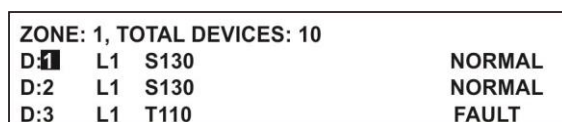

Use the arrow buttons to review the list of all devices associated to the zone. You can also review the device state and settings with pressing the ENTER button.

Exit to the main screen of ZONES menu is pressing button ENTER or CANCEL.

7.2.2 Zones Testing

From the main screen of ZONES menu, select a zone number using the up and down arrow buttons and press button (3) TEST.

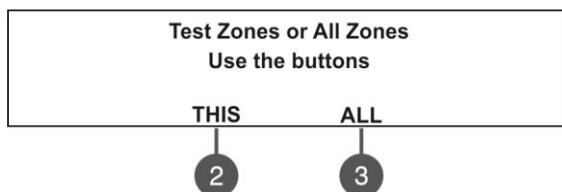

The system will ask for confirmation whether to run the test only for the selected zone number (button (2) THIS) or for all zones in the system (button (3) ALL).

The zone(s) status is changed to TEST mode. The LED 'Test' is lighting on permanently.

During the test mode the installer activates detectors in the zone (applies heat or smoke) to check their proper operation. The panel confirms the receiving of fire alarm messages with short sound signals and the number of the tested zone is blinking. Note: During testing zones 17-48 will blink the LED 'Test' only!

To stop the zone test, press the (3) 'STOP TEST' functional button. The zone returns to normal operation mode.

After completing the zone testing, reset the panel, as described in item 6.9.

7.2.3 Disabling Zones

From the main screen of ZONES menu, select a zone number using the up and down arrow buttons and press button (4) DISABLE. The zone status is changed to DISABLED – the panel stops following the status of the connected devices to the zone and will not alert for alarms and faults from them. The LED ‘Disable’ lights up permanently. To enable the zone press the (4) ENABLE button:

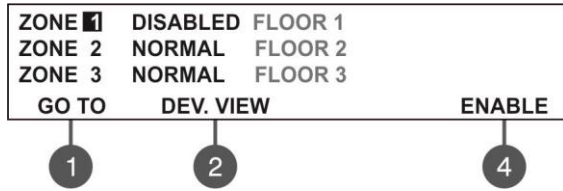

Note: If at the moment of enabling the zone, there are activated devices connected to it (fire alarm or fault condition) the panel will alert for that immediately!

7.2.4 Programming Zone Parameters

Attention: Programming zone parameters is available only from access level 3!

From the main screen of ZONES menu the User can set additional parameters for every zone in the system. To set zone parameters, select its number using the up/ down arrow buttons and press ENTER button.

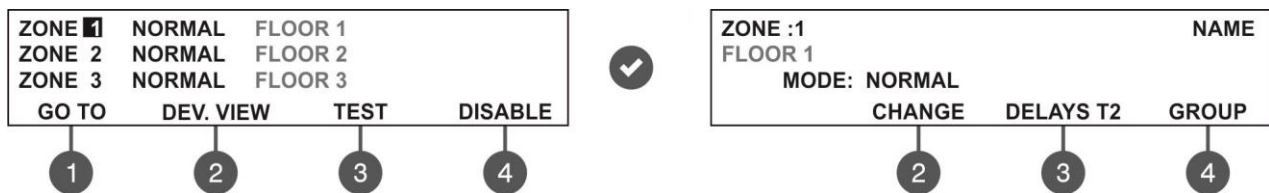

In the new sub screen first you can enter a 40-symbol long name for the zone. Use the functional button to set the operation mode, delays T2 and a group number.

7.2.5 Zone Name

The User can enter a specific name for the zone after entry in the submenu for zone parameters setting. The name can be up to 40 digits long and it is entered on the second row. Use the left and right arrows to move the cursor. The symbols (small and capital letters and characters) are set with the up and down arrows. Confirm the entered name with ENTER button. See also the APPENDIX B – Table for text and symbols available for zone and device names.

7.2.6 Zone Operation Modes

For a zone can be set one operation mode: **NORMAL / 2 DEVICES/ DOUBLE**.

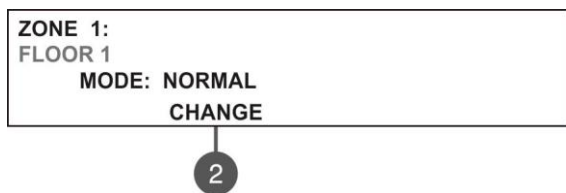

Every pressing of button (2) CHANGE will alternatively change the operation mode of the zone: NORMAL/ / 2DEVICES/ DOUBLE.

The set mode is confirmed with ENTER button.

- In **NORMAL** mode any detector activation within the system generates an alarm event to the respective zone.
- In **2 DEVICES** mode any detector activation within the system generates a PREALARM event to the respective zone, but also awaits the activation of another detector from the same zone to generate a FIRE signal. The RESET command shall disable the FIRE and PREALARM events. If during 5 minutes there is no other fire alarm signal from other detector in the zone the FIRE alarm will be ignored. The operation of a zone in 2 DEVICES action mode is shown in the examples below.
- In **DOUBLE** mode any detector activation within the system generates a PREALARM event to the respective zone, but will awaits a second fire signal from the same detector to generate a FIRE signal. The RESET command shall disable the FIRE and PREALARM events. If during 5 minutes there is no other fire alarm signal from the same detector in the zone the FIRE alarm will be ignored.

Examples for 2 DEVICES action mode operation:

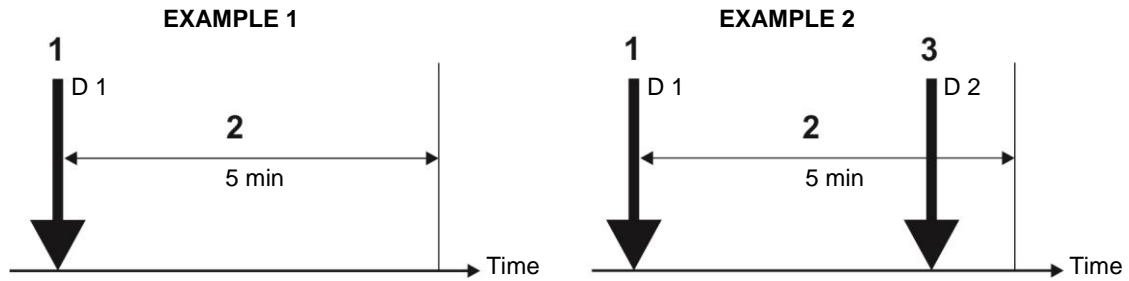

- 1 – An incoming alarm signal from Detector 1 and zone reset;
- 2 – Awaiting for a second alarm signal from other detector in the zone – Pre Alarm Mode;
- 3 – Second alarm signal from Detector 2 in the zone.

Examples for DOUBLE action mode operation:

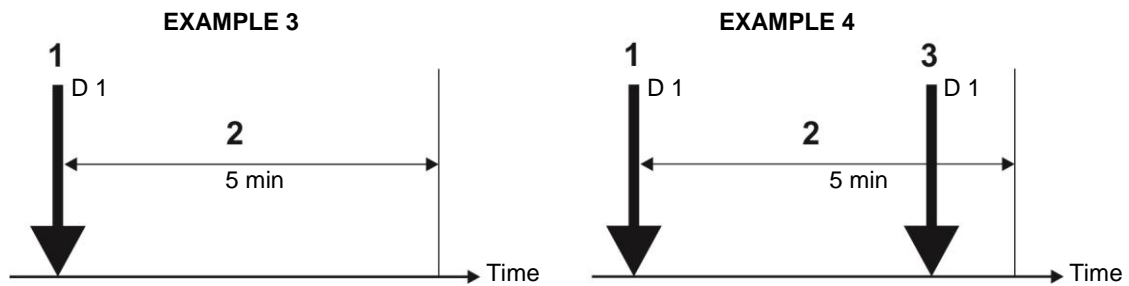

- 1 – An incoming alarm signal from Detector 1 and zone reset;
- 2 – Awaiting for a second alarm signal from the same detector in the zone – Pre Alarm Mode;
- 3 – Second alarm signal from Detector 1 in the zone.

EXAMPLES 1, 3: In this case the fire panel will not activate the sounders and the signalization on the front panel because during time interval 2 no second alarm signal is generated.

EXAMPLES 2, 4: In this case the fire panel will activate the sounders and the signalization on the front panel because during time interval 2, two alarm signals are generated.

After RESETTING of the panel, the events FIRE and PRE ALARM are cleared, and LED 'General Fire' light off.

7.2.7 Programming Delays T2

T2 represents times for individual delay setting for activation of FIRE output and the sounders outputs SND1 and SND2. For details see also APPENDIX D – “Two steps of alarming” algorithm.

To enter in the submenu for DELAY T2 setting, press button (3) DELAY T2 from the zone parameters programming screen.

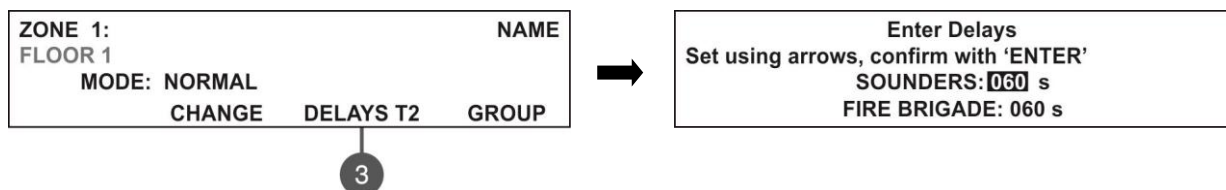

- In the **SOUNDERS** field set the time delay for sounders (SND1 and SND2) outputs activation. The time delay can be in range from 0 up to 540 seconds.
- In the **FIRE BRIGADE** field set the time delay for FIRE output activation. The time delay can be in range from 0 up to 540 seconds.

In case of activation of more than one zone, the delays to the outputs are caused by the zone with shorter delays. By default a 60 seconds time delays T2 are set.

The editing value is blinking. Set the time delays using the navigation buttons: up (increasing) and down (decreasing) arrows to change the value, and left and right arrows to move over the fields.

The set time delays T2 are confirmed with the ENTER button.

7.2.8 Arranging Zones in Groups

The zones in SIMPO addressable fire alarm panel can be organized for operation in separate groups. The maximum number of the permissible groups is 9. By default all zones are not associated to a group number – value 0 is set.

To enter in the submenu for group setting, press button (4) GROUP from the zone parameters programming screen.

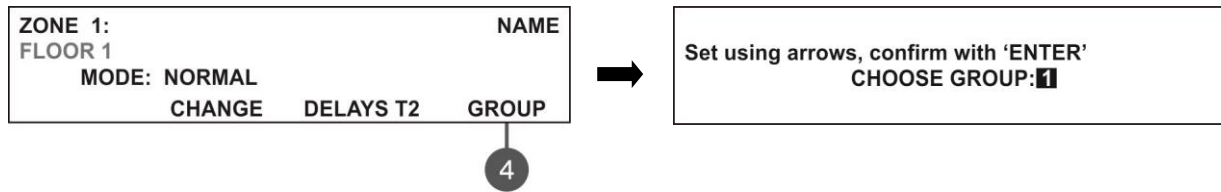

In the field **CHOOSE GROUP** set the number of the group from 1 to 9. To increase the value press 'up arrow' button and to decrease it – the 'down arrow' button. The set group number is confirmed with ENTER button.

Exit to the main screen of ZONES menu is realized with CANCEL button.

7.3. Devices Setup Menus

This menu allows the installer to review and change the status of every device. Up to 250 devices per loop are available for settings (up to 500 when using second loop in the SIMPO panel). In the 'DEVICES SETUP' menus the installer can save new devices found in the system, to remove or disable them. The parameters and settings may differ according the device type. The currently edited device address is blinking. The menu is accessible from levels 2 and 3.

From the main screen of DEVICES SETUP menu, the User can review detailed information for all connected devices in the system configuration.

Example for the screen display after entering the menu:

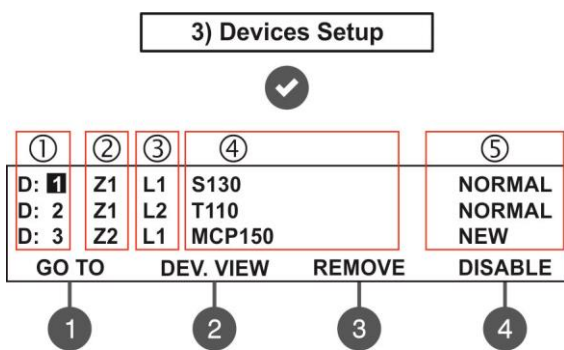

The screen is divided in the following sections:

- 1 – Address of the device.
- 2 – Zone number.
- 3 – Loop number.
- 4 – System name of the device according its type.
- 5 – The current status of the device:
 - **NEW** – The device is new in the system. To save it press button (3) SAVE – see item 7.3.2.
 - **NORMAL** – The device is in normal operation mode.
 - **FAULT** – The device is not responding. To delete it press (3) REMOVE – see item 7.3.3.
 - **TYPE ERROR** – The type of the device is different from the previously saved one. The type of the device could be quickly fixed with pressing the (3) FIX button – see item 7.3.5.
 - **DISABLED** – The device is disabled.
 - **FIRE** – The device is in fire mode.
 - **NONE** – No device at the address.

The address number of the currently editing device is blinking. Additional submenus are available through the functional digit buttons.

7.3.1 Submenus for General Setting

From the main screen of DEVICES SETUP menu use the functional buttons for submenus: (1) GO TO and (2) DEV. VIEW.

Submenu (1) GO TO allows quick access to a device address in the respective loop number. The currently editable value is blinking. Use up and down arrows to select device address. Use the left and right arrows to switch over the editable fields. Confirm with 'ENTER'.

Submenu (2) DEV. VIEW allows the User to check the total number of the devices connected to Loop 1 or Loop 2 – the loop number to which the selected device is currently connected. The exit to the main screen of DEVICES SETUP menu is with pressing ENTER or CANCEL button.

7.3.2 Saving the New Found Devices

The SIMPO TTE LOOP controller automatically recognizes the types of devices in the loop. In case of finding new devices in the system configuration (Loop 1 or Loop 2) the panel displays the message “New Loop Devices Found”, followed by information for the total number of the new devices and the loop number. The new found devices in the system are presented with a fault type message on the main screen and a pulsed sound signal. You can silence the buzzer with pressing the ‘SILENCE BUZZER’ button. Then enter the installation menu and select ‘3. Devices Setup’ Menu. Press ‘ENTER’ button and follow the structure below.

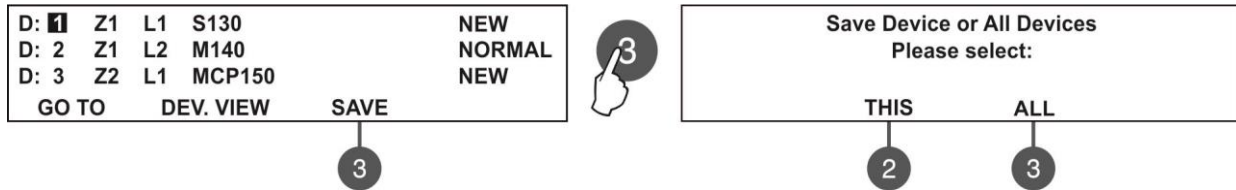

To save the new found devices press the (3) SAVE button. The panel will ask if you want to save the selected device only (button (2) THIS) or all new found devices (button (3) ALL) in the respective Loop number. The exit is automatic to the main screen DEVICES SETUP, as the saved devices are in normal operation mode. For example, if the selected device is connected to Loop 1, when pressing the button (3) ALL, all new found devices connected to Loop 1 will be saved in the system configuration. To save in the system configuration all new found devices connected to Loop 2, the installer has to select a new device in Loop 2 and press button (3) ALL. Quick switching between Loop 1 and Loop 2 can be performed with button (1) GO TO.

Note: The panel automatically saves the new devices on the serial address. The other types of addressing or changing the current set address are described in item 7.4.

7.3.3 Deleting Devices

Every loop device can be deleted from the system configuration (Loop 1 or Loop 2) in the DEVICES SETUP menu. To delete one or all devices from the respective loop configuration, select the address of the device using up/ down arrow buttons and press button (3) REMOVE.

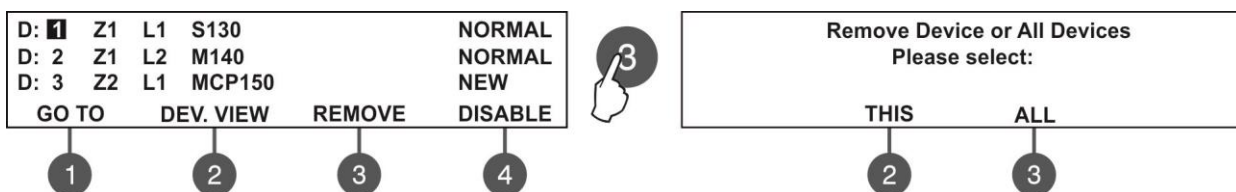

The panel will ask if you want to remove the selected device only (button (2) THIS) or all present devices (button (3) ALL) in the respective Loop number. The exit is automatic to the main screen DEVICES SETUP. For example, if the selected device is connected to Loop 1, when pressing the button (3) ALL, all present devices connected to Loop 1 will be removed (deleted) from the system configuration. To remove from the system configuration all present devices connected to Loop 2, the installer has to select a device in Loop 2 and press button (3) ALL. Quick switching between Loop 1 and Loop 2 can be performed with button (1) GO TO.

Note: If after deleting, the removed devices are still connected physically to the system, the panel will find them and will alert with “New Loop Devices Found” fault messages. To avoid this, it is recommended first to disconnect the device from the system and after that to remove it from DEVICES SETUP menu.

7.3.4 Disabling Devices

Every loop device can be disabled, as the panel will not follow the operation of the disabled device and will not respond to fire or fault messages from it. The LED 'Disable' on the front panel is lighting on.

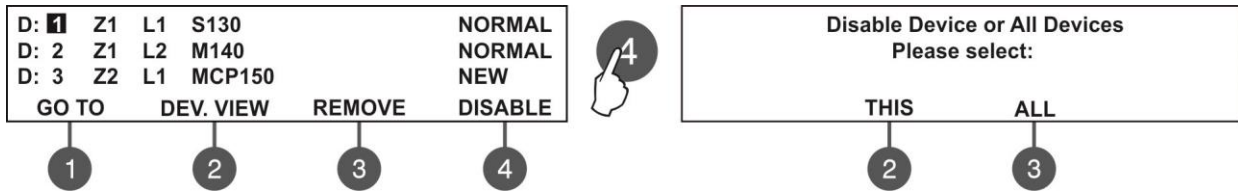

The panel will ask if you want to disable the selected device only (button (2) THIS) or all present devices (button (3) ALL) at the respective Loop number. The exit is automatic to the main screen DEVICES SETUP, as the disabled devices are displayed with status DISABLED.

For example, if the selected device is connected to Loop 1, when pressing the button (3) ALL, all present devices connected to Loop 1 will be disabled in the system configuration. To disable in the system configuration all present devices connected to Loop 2, the installer has to select a device in Loop 2 and press button (3) ALL. Quick switching between Loop 1 and Loop 2 can be performed with button (1) GO TO.

To enable the device again, select its address and press the active button (4) ENABLE.

Note: If at the moment of enabling the device, it is in fire alarm mode (the fire signal was generated earlier, when the device was still disabled) the panel will alert for the fire alarm situation immediately!

7.3.5 Fixing of Wrong Type Devices

When a device is replaced physically in the system configuration with other type of device, the panel will change its status to TYPE ERROR. The installer can quickly correct that using the (3) FIX button, as the name and the zone number will be saved for the new device.

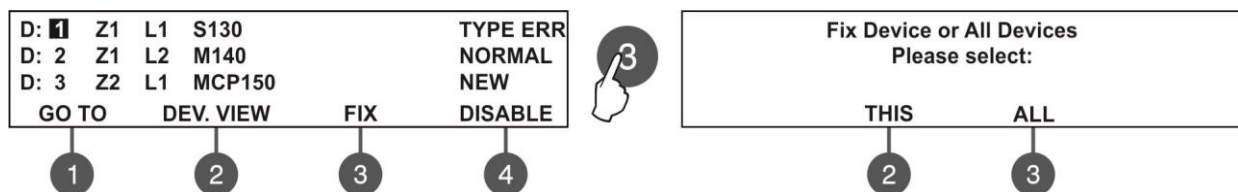

From the main screen of DEVICES SETUP menu, select the device address with TYPE ERROR status and press (3) FIX button. The panel will ask if you want to fix the type of the selected device only (button (2) THIS) or all devices with wrong type (button (3) ALL) in the respective Loop number. The exit is automatic to the main screen DEVICES SETUP, as the fixed devices are displayed with status NORMAL.

7.3.6 Programming of Device Parameters

Attention: Programming device type parameters is available only from access level 3!

The SIMPO fire alarm addressable panel operates with full range of SensoIRIS addressable detectors, call points, sounders and modules via Teletek Electronics (TTE) communication protocol. According the type of the device, the setting parameters are different. Use the descriptions below to set the devices in your system configuration.

To set parameters of a device go to its address number in the DEVICES SETUP menu (the editable address number is blinking) and press 'ENTER'.

Note: You can make the device settings also for NEW and DISABLED devices.

Some parameters are common for all device types and are set in one and the same way:

- **Association to a zone number.** The first editable parameter is setting the zone number for this device. Use the up and down arrows to set the zone number according your specific system configuration. By default all devices are associated to Zone 1.
- **Entering of a specific name.** The installer can enter a specific name for every device. The name can be up to 40 digits long and it is entered on the second row. Use the left and right arrows to move the cursor. The symbols (small and capital letters and characters) are set with the up and down arrows. Confirm the entered name with “ENTER”. See also the APPENDIX B.

Two special buttons are implemented in the setup menus of the SensolRIS addressable devices:

- **Button ON/ OFF TURN** – Using this button the installer can manually to turn on the LED of a device (or the sound for sounders WSOU, WSOU IS, BSOU and BSOU IS) when checking its place of installation or checking for double addresses in the system. When setting **ON** state, the LED of the device lights on permanently in red (sounders WSOU, WSOU IS, BSOU and BSOU IS are activated). After exiting the device setup menu, the button turns automatically **OFF** and the device’s LED is off too.

Note: SensolRIS devices MC-D, MINP, WSOU, WSOU IS, BSOU and BSOU IS have no LED indication.

- **Button ON/ OFF LED BLINK** – Using this button the installer can enable or disable the LED indication showing the communication between the panel and the respective device. When setting **ON** state, the LED of the device starts blinking at every 10 seconds in normal operation mode.

Note: SensolRIS devices MC-D, MINP, WSOU, WSOU IS, BSOU and BSOU IS have no LED indication for showing the communication with the panel.

In the setup menu of every device is introduced a **system ID field** with a unique 10-digit number – the ID number of the device for identification in the system configuration.

Use the functional digit buttons to enter the respective submenus according the type of the selected device.

SensolRIS S130 – Optical-smoke detector
SensolRIS S130 IS – Optical-smoke detector with isolator

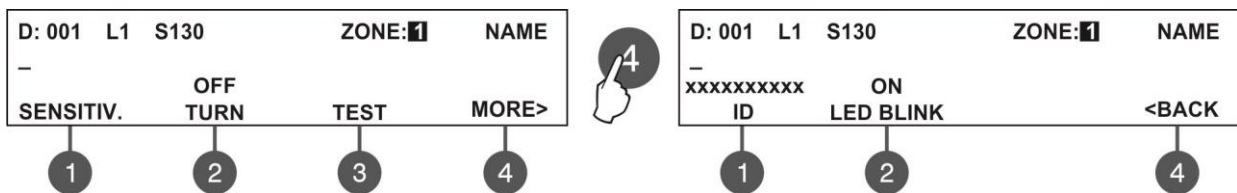

Use the functional buttons to set the following specialized parameters:

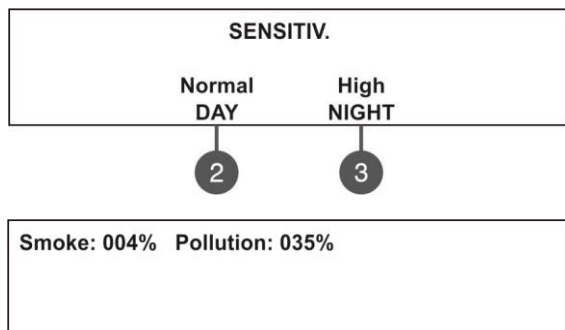

(1) SENSITIV. – Press the button to enter the submenu for setting the sensitivity level of the smoke chamber for DAY and NIGHT alarm mode.

Use the functional buttons (2) DAY and (3) NIGHT to select the sensitivity level: Normal/ Middle/ Low/ High. All set sensitivity levels are confirmed with ENTER button.

(3) TEST – Press the button to enter in a new screen for checking of the following current parameters:

- *Smoke*: Shows in percent the current level of smoke in the detector’s smoke chamber.
- *Pollution*: Shows in percent the current level of pollution in the detector’s smoke chamber.

The exit to the main screen is with pressing the CANCEL button.

SensolRIS T110 – Heat Detector
SensolRIS T110 IS – Heat Detector with isolator

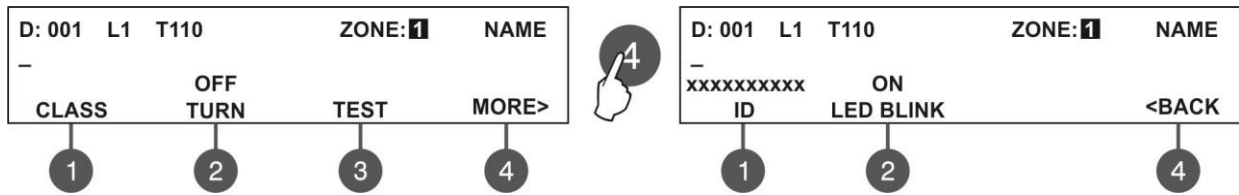

Use the functional buttons to set the following specialized parameters:

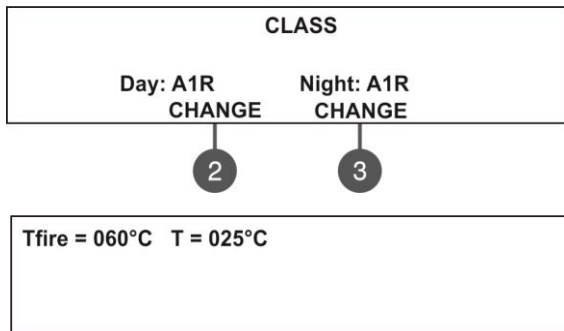

- (1) **CLASS** – Press the button to enter the submenu for setting the class for DAY and NIGHT alarm mode. Use the functional buttons (2) and (3) to select the class: A1R/ A2S/ BS. The selected class is confirmed with ENTER button.
- (3) **TEST** - Press the button to enter in a new screen for checking of the following current parameters:
 - *T fire* – Shows the operating temperature of the detector, in degrees centigrade.
 - *T* – Shows the current temperature in the room, in degrees centigrade. The selected class is confirmed with ENTER button.

The exit to the main screen is with pressing the CANCEL button.

SensolRIS M140 – Combined optical-smoke and heat detector
SensolRIS M140 IS – Combined optical-smoke and heat detector with isolator

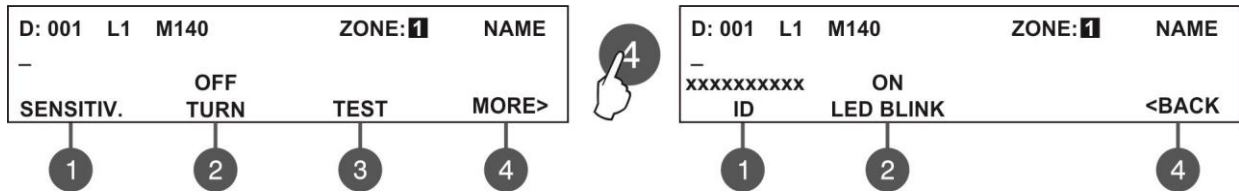

Use the functional buttons to set the following specialized parameters:

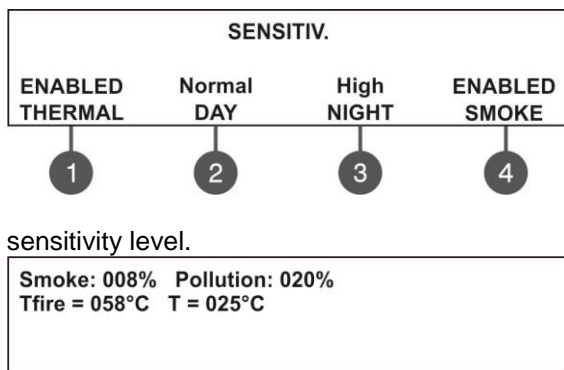

- (1) **SENSITIV.** – Press the button to access the following additional setting menus:
 - (1) – Enabling/ Disabling the operation of the thermal part of the detector. Every pressing of the button changes alternatively the parameter.
 - (2) – Setting the sensitivity level in DAY operation mode: Normal/ Middle/ Low/ High. Press the button until reaching the desired sensitivity level.
 - (3) - Setting the sensitivity level in NIGHT operation mode: Normal/ Middle/ Low/ High. Press the button until reaching the desired sensitivity level.
 - (4) - Enabling/ Disabling the operation of the smoke part of the detector. Every pressing of the button changes alternatively the parameter.

- (3) **TEST** – Press the button to enter in a new screen for checking of the following current parameters:
 - *Smoke*: Shows in percent the current level of smoke in the detector’s smoke chamber.
 - *Pollution*: Shows in percent the current level of pollution in the detector’s smoke chamber.
 - *T fire*: Shows the operating temperature of the detector, in degrees centigrade.
 - *T*: Shows the current temperature in the room, in degrees centigrade. The selected class is confirmed with ENTER button.

The class for SensolRIS M140 is fixed to A1R and could not be changed.

The exit to the main screen is with pressing the CANCEL button.

SensolRIS MCP150 – Manual call point
SensolRIS MCP150 IP67 – Manual call point for outdoor mounting

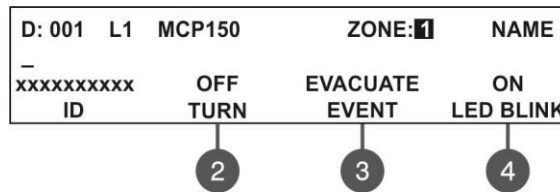

Use the functional buttons to set the following specialized parameters:

(3) EVENT EVACUATION/ ALARM – Every pressing of the button alternatively changes the type of the event generated with activation of the manual call point:

- **Event EVACUATION** – The sounders will be activated immediately, as the set time delays T1 and T2 are ignored.
- **Event ALARM** – The set time delays T1 and T2 are active and the manual call point operated as an automatic detector.

SensolRIS WSOU – Wall mounted sounder
SensolRIS WSOU IS – Wall mounted sounder with isolator

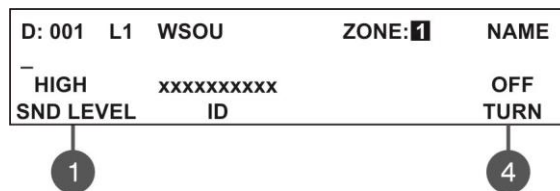

Use the functional buttons to set the following specialized parameters:

(1) SND LEVEL – Every pressing of the button alternatively changes the sound level between HIGH/ LOW – as this depends on the number of the connected sounders to the loop:

- **HIGH** – Set in those cases when **the number of the connected sounders* to the loop is up to 30.**
- **LOW** – Set in those cases when **the number of the connected sounders* to the loop is up to 60.**

* Sounders WSOU, WSST, WSOU IS and WSST IS.

(4) ON/ OFF TURN – Press to switch on/ off the sound of the sounder when checking for double addresses or finding the place of installation.

SensolRIS WSST – Wall mounted sounder and strobe
SensolRIS WSST IS – Wall mounted sounder and strobe with isolator

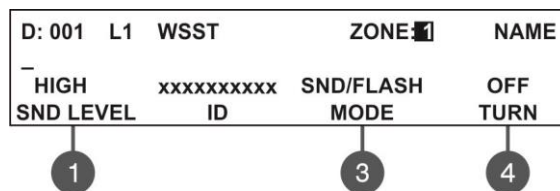

Use the functional buttons to set the following specialized parameters:

(1) SND LEVEL – Every pressing of the button alternatively changes the sound level between HIGH/ LOW – as this depends on the number of the connected sounders to the loop:

- **HIGH** – Set in those cases when **the number of the connected sounders* to the loop is up to 30.**
- **LOW** – Set in those cases when **the number of the connected sounders* to the loop is up to 60.**

* Sounders WSOU, WSST, WSOU IS and WSST IS.

(3) MODE – Press to choose the operation mode of the sounder:

- SND – Sounder activation only in FIRE mode;
- FLASH – Flash indication only in FIRE mode;
- SND/ FLASH – Both sounder and flash indication are active in FIRE mode.

(4) ON/ OFF TURN – Press to switch on/ off the sound and LED indication of the sounder when checking for double addresses or finding the place of installation.

SensolRIS BSOU – Base with sounder
SensolRIS BSOU IS – Base with sounder with isolator

D: 001	L1	BSOU	ZONE: 1	NAME
-	HIGH	xxxxxxxxxx		OFF
	SND LEVEL	ID		TURN

1
4

Use the functional buttons to set the following specialized parameters:

(1) SND LEVEL – Every pressing of the button alternatively changes the sound level between HIGH/ LOW – as this depends on the number of the connected sounders to the loop:

- **HIGH** – Set in those cases when **the number of the connected sounders* to the loop is up to 30.**
- **LOW** – Set in those cases when **the number of the connected sounders* to the loop is up to 100.**

* Sounders BSOU, BSST, BSOU IS and BSST IS.

(4) ON/ OFF TURN – Press to switch on/ off the sound of the sounder when checking for double addresses or finding the place of installation.

SensolRIS BSST – Base with sounder and strobe
SensolRIS BSST IS – Base with sounder and strobe with isolator

D: 001	L1	BSST	ZONE: 1	NAME
-	HIGH	xxxxxxxxxx	SND/FLASH	OFF
	SND LEVEL	ID	MODE	TURN

1
3
4

Use the functional buttons to set the following specialized parameters:

(1) SND LEVEL – Every pressing of the button alternatively changes the sound level between HIGH/ LOW – as this depends on the number of the connected sounders to the loop:

- **HIGH** – Set in those cases when **the number of the connected sounders* to the loop is up to 30.**
- **LOW** – Set in those cases when **the number of the connected sounders* to the loop is up to 100.**

* Sounders BSOU, BSST, BSOU IS and BSST IS.

(3) MODE – Press to choose the operation mode of the sounder:

- SND – Sounder activation only in FIRE mode;
- FLASH – Flash indication only in FIRE mode;
- SND/ FLASH – Both sounder and flash indication are active in FIRE mode.

(4) ON/ OFF TURN – Press to switch on/ off the sound and LED indication of the sounder when checking for double addresses or finding the place of installation.



Attention: It is possible to connect different type of sounders to the loop at the same time, but the total consumption of the sounders in the loop must be up to 300mA!

Note: The automatic detectors mounted to bases BSOU, BSOU IS, BSST and BSST IS are assigned at separate addresses in the control panel!

To calculate the total consumption of the sounders in the loop and to define the proper sound level, you can use the Table a below, as fill in the number of the used sounders according their type.

Table 1 for calculation of the total consumption of the sounders in the loop with defined sound level and set **ALARM and/or **EVACUATE TONE type 27** (see item 7.6.6 Sounders Mode):**

Sounder	Number	HIGH Sound Level	LOW Sound Level	Total consumption, mA (HIGH + LOW)
WS		___ x 16,5mA	___ x 5mA	
WS IS		___ x 16,5mA	___ x 5mA	
WSOU		___ x 16,5mA	___ x 5mA	
WSOU IS		___ x 16,5mA	___ x 5mA	
WSST		___ x 22mA	___ x 12mA	
WSST IS		___ x 22mA	___ x 12mA	
BSOU		___ x 10mA	___ x 3mA	
BSOU IS		___ x 10mA	___ x 3mA	
BSST		___ x 10mA	___ x 3mA	
BSST IS		___ x 10mA	___ x 3mA	
Consumption of the sounders in the loop:				

Table 2 for calculation of the total consumption of the sounders in the loop with defined sound level and set **ALARM and/or **EVACUATE TONE other type sound** (see item 7.6.6 Sounders Mode):**

Sounder	Number	HIGH Sound Level	LOW Sound Level	Total consumption, mA (HIGH + LOW)
WS		___ x 10mA	___ x 4mA	
WS IS		___ x 10mA	___ x 4mA	
WSOU		___ x 10mA	___ x 4mA	
WSOU IS		___ x 10mA	___ x 4mA	
WSST		___ x 16,5mA	___ x 11mA	
WSST IS		___ x 16,5mA	___ x 11mA	
BSOU		___ x 10mA	___ x 3mA	
BSOU IS		___ x 10mA	___ x 3mA	
BSST		___ x 10mA	___ x 3mA	
BSST IS		___ x 10mA	___ x 3mA	
Consumption of the sounders in the loop:				

SensolRIS MINP – Mini input module

The SensolRIS MINP is a compact module with one input. The module monitors and transfers to control panel the state of this input - state ON or state OFF. SensolRIS MINP is designed for built-in installation in the mounting box of a device.

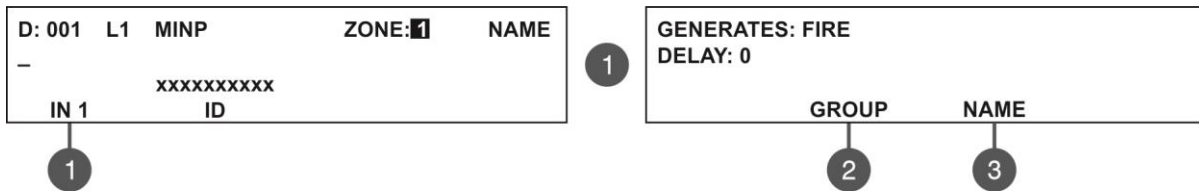

The activation of the SensolRIS MINP input can be programmed according the application. To program the generated event at the input, press button **(1) IN** – in the submenu are active three fields for setting:

- **GENERATES** – Use the up/ down arrow buttons to select generated event at the input: FIRE/ EVACUATE/ RESET/ MESSAGE ALARM/ MESSAGE FAULT/ MESSAGE WARNING/ SILENCE BUZZER/ SILENCE ALARM/ CLASS CHANGE*/ SILENCE ALARM (STROBE ON)**
- **DELAY** – The field is common for all events. Enter time delay 0-600 sec for activation event.

* CLASS CHANGE - To use the class change function, connect the terminals of a switch with normally open contacts to the module terminals.

** SILENCE ALARM (STROBE ON) – Use to disable the sounders in case of evacuation event, for example when using the panel together with a separate Voice Evacuation System. The sounders will be silent, but their LED signalization will be active (WSST, WSST IS, BSST and BSST IS) regardless their individual settings.

Use the left and right arrows to switch over the GENERATES and DELAY fields.

(2) GROUP - Press the functional button to enter in a submenu for group selection. In the editing field enter the group number using the up/ down arrow buttons.

(3) NAME – Press the functional button to enter a specific name for the module’s input.

All set parameters are confirmed with ENTER button. The exit to the main screen of DEVICES SETUP menu is with pressing CANCEL button.

SensolRIS MC-D – Addressable module for conventional detectors SensoMAG series

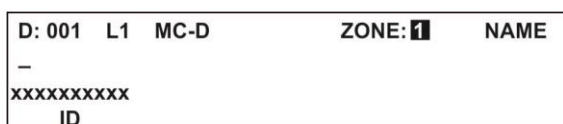

The module is used for connection of conventional detectors SensoMAG series.

The installer sets the zone number for the device and can enter a specific name.

SensolRIS MIO-04 – Module with 4 outputs

The programming is same for all of the outputs. Use the functional buttons to select an output number. To program OUT 4 you have to press button MORE >>. To see the ID number of the module press MORE >> button again.

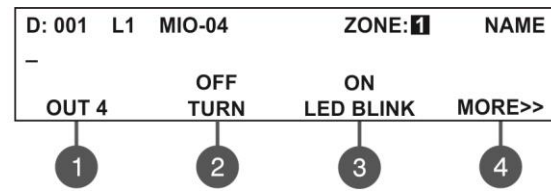
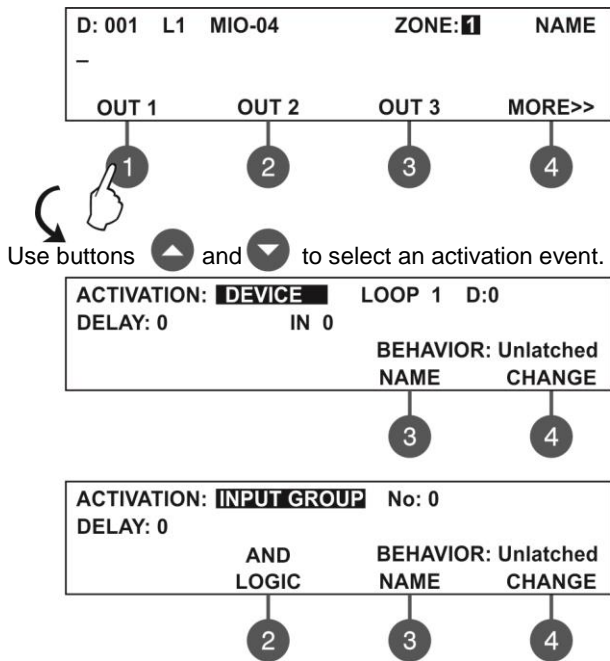

The installer has to choose an activation event using the up and down arrows. Use the left and right arrows to switch over the editable fields.

- **DEVICE** - Activation from a device. Set the loop number and device address. The 'INPUT' field refers only to modules with inputs.
- **INPUT GROUP** - Activation from a device in group. Set the group number. The functional button (2) switches alternatively between the AND and OR logic operation.
- **FIRE ZONE** - Activation from a zone in fire alarm. Set a zone number. In the 'ALARMS' field you can enter a number of registered fire alarms, when after reaching their count the output will be activated.

- **FIRE ZONE GROUP** - Activation from a zone in fire alarm included in a group. Set a group number.
- **FIRE (common)** - Activation in case of fire alarm event in the system.
- **FAULT ZONE** - Activation from a zone in fault. Set a zone number.
- **FAULT ZONE GROUP** - Activation from a zone in fault included in a group. Set a group number.
- **FAULT (common)** - Activation in case of fault event in the system.
- **FAULT SYSTEM** - Activation in case of fault system event in the system.
- **PREALARM** - Activation in case of preliminary alarm fire alarm event.
- **DISABLE (common)** - Activation in case of disablement in the system.
- **SOUNDER ON*** - Activation in case of sounder activation in the system.
- **RESET** - Activation in case of reset in the system.
- **EVACUATE** - Activation in case of evacuation event in the system.
- **EVACUATE ZONE GROUP** – Activation in case of “Evacuation” and “Fire Alarm” in the respective group.
- **SILENCE BUZZER** - Activation in case of silence buzzer in the system.
- **SILENCE ALARM** - Activation in case of silence alarm in the system.
- **TEST** - Activation in case of test in the system.
- **VOICE CYCLE** – Activation in case starting “EVAC. CYCLE ON” time and deactivation in case starting “EVAC. CYCLE OFF” time (the ON and OFF parameters are set in the EVAC. CYCLE submenu in the EVACUATION SETTINGS menu – see item 7.6.6).
- **SOUNDER ON (zonal)*** – The output is used for activation of conventional sounders connected to SensolRIS MOUT module – for details see description of SensolRIS MOUT on following pages.

** Note: The outputs with programmed SOUNDER ON and SOUNDER ON (zonal) activation events will be deactivated during active input events like SILENCE ALARM and SILENCE ALARM (STROBE ON) – see the menus for SensolRIS-MINP. The typical application is when the panel operates with an autonomous voice evacuation system and the sounders must be silenced during announcing of the voice messages.*

In addition the following fields are accessible for editing:

DELAY - The setting is common for all activation types. Enter time delay 0-600 sec. Use the left and right arrows to switch over the ACTIVATION and DELAY fields.

LOGIC - Press the functional button (2) to switch over AND - OR logic for operation.

NAME - Press the functional button (3) to enter a specific name for this activation output event.

BEHAVIOR CHANGE - Press the functional button (4) to set the behavior Latched or Unlatched.

The set activation event is confirmed with ENTER button. Exit to the main screen for device setup is done with CANCEL button.

SensolRIS MIO-22 – Module with 2 inputs and 2 outputs

The programming is same for all of inputs and outputs. Use the functional buttons to select an input or output number. To program OUT 2 you have to press button MORE >>. To see the ID number of the module press MORE >> button again.

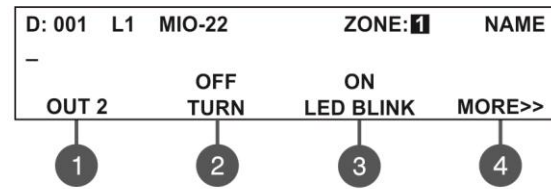
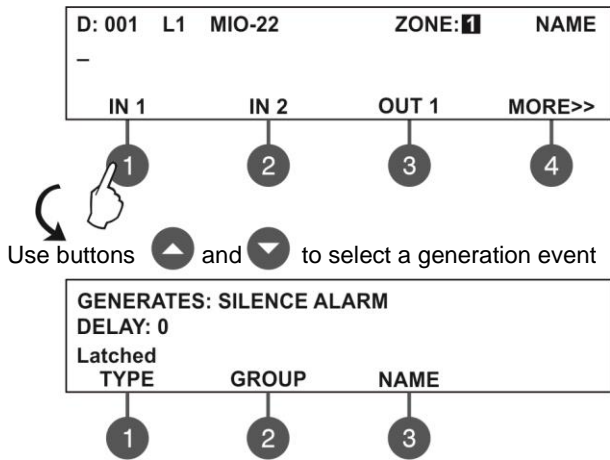

Use the functional buttons to set parameters for inputs and outputs.

For the settings of the OUT 1/ 2 refer to the submenus of SensolRIS MIO-04.

For the settings of the IN 1/ 2 refer to the submenu of SensolRIS-MINP.

- (1) **TYPE** functional button is accessible in the submenus for input settings of the module. Every pressing of the button changes the state with options Latched/Unlatched. The description of the option operation is as follows:
- **Latched** option*. The input will be activated from a signal with duration up to 2.5 seconds. Typical application is when a pull cord switch module or emergency call buttons are connected to the module's input and a quick respond is needed. The event will stay active until resetting from the panel.
 - **Unlatched** option*. The input will be activated from a signal with duration higher than 10 seconds. The event will stay active until duration of the signal.

* **Note:** The Latched/Unlatched options are irrelevant when FIRE, EVACUATE or MESSAGE ALARM event is set for activation of the input. In this case after the input activation the mentioned above events will stay active until resetting from the panel.

(2) **GROUP** functional button – use to associate IN 1/ 2 for operation in a group, press button in the screen of the respective input number. In the editing field enter the group number using the up/ down arrow buttons.

(3) **NAME** functional button to enter a specific name for the module's input.

SensolRIS MIO-40 – Module with 4 inputs

The programming is same for all of the inputs. Use the functional buttons to select an input number. To program IN 4 you have to press button MORE >>. To see the ID number of the module press MORE >> button again.

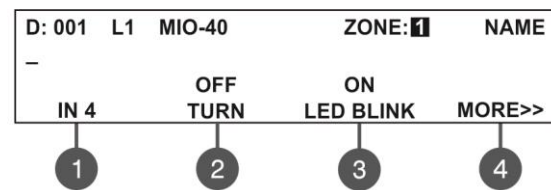
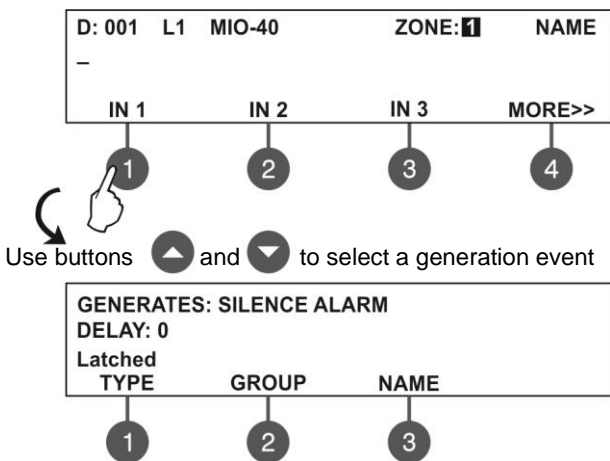

Use the functional buttons to set parameters for the inputs.

For the settings of the IN 1/ 2/ 3/ 4 refer to the submenu of SensolRIS-MINP.

The functionality of (1) TYPE button is described above in SensolRIS MIO-22 menus.

SensolRIS MOUT – Module potential output

The module is used for connection of conventional sounders, providing interface connection between a zone with conventional sounders and SIMPO fire alarm panel. Use the functional buttons to set the following specialized parameters:

D: 001	L1	MOUT	ZONE: 1	NAME
-			xxxxxxxxxx	ON
OUT 1	OFF	TURN	ID	LED BLINK

1

2

4

(1) OUT 1 – Set the parameters for the output – see the description of module SensolRIS MIO-04.

ACTIVATION: DEVICE	LOOP 1	D:1
DELAY:0	IN 1	
NORMAL	BEHAVIOR: Unlatched	
POLARITY	NAME	CHANGE

1

3

4

(1) POLARITY - Use this button to set the type of operation of the module's relay. Every pressing of the button changes alternatively the polarity type:

- *NORMAL POLARITY* - The module's relay will switch on when receiving of activation signal and will switch off when the signal is lost.

- *INVERTED POLARITY* - The module's relay will switch on when the signal is lost and will switch off when receiving of activation signal.

ACTIVATION: SOUNDER ON (ZONAL)	ZONE: 1
DELAY:0	
NORMAL	BEHAVIOR: Unlatched
POLARITY	NAME
	CHANGE

1

3

4

Attention: The event "SOUNDER ON (Zonal)" is used for zonal activation of the conventional sounders connected to the module. The output active state during evacuation cycle running is as follows:

Evacuate settings (item 7.6.6)	Output state
SOUND/FLASH	ON
SOUND	ON
FLASH	OFF

NAME - Press the functional button (3) to enter a specific name for this activation output event.

BEHAVIOR CHANGE - Press the functional button (4) to set the behavior Latched or Unlatched.

All set parameters are confirmed with ENTER button. The exit to the main screen of DEVICES SETUP menu is with pressing CANCEL button.

SensolRIS MOUT-240 – Module for 240V interface (with 1 or 2 relay outputs)

D: 001	L1	MOUT 240/1	ZONE: 1	NAME
-			xxxxxxxxxx	ON
OUT 1	OFF	TURN	ID	LED BLINK

1

2

4

Relay module with interface for 240 VAC. The module is available in two versions with 1 and 2 relay outputs.

Use the functional buttons to set the following parameters:

(1) OUT 1 – Set the parameters for the output – see the description of module SensolRIS MIO-04.

Note: In the menu of SensolRIS MOUT240/2, the second output is selected with button (2) OUT 2, and the ID number and ON/ OFF LED BLINK button are available on after pressing of (4) MORE >> button.

All set parameters are confirmed with ENTER button. The exit to the main screen of DEVICES SETUP menu is with pressing CANCEL button.

SensolRIS MC-Z – Module conventional zone

D: 001	L1	MCZ	ZONE: 1	NAME
xxxxxxxxxx				ON
ID	OFF	TURN		LED BLINK

2

4

This is a conventional zone module for connecting up to 32 conventional detectors. The module monitors and sends warning messages for the following fault events: fire alarm, short-circuit, removed detector from its base and breaking off the loop line (when operating with SensoMAG conventional detectors is a must to connect an EOL module at the end of the line).

All set parameters are confirmed with ENTER button. The exit to the main screen of DEVICES SETUP menu is with pressing CANCEL button.

SensolRIS GAS – GAS Detector

D: 001	L1	GAS DETECTOR	ZONE:1	NAME
-				
xxxxxxxxxx				
ID				OFF SOUNDER

4

SensolRIS GAS is a gas detector designed for application in addressable fire alarm systems built with SIMPO and IRIS addressable fire alarm panels.

SensolRIS GAS is designed for detection of leaking natural gas and LPG. The detector is equipped with alarm output for management of manipulator or electromagnetic valve (optional accessories).

Use the functional buttons to set the following parameters:

(4) ON/ OFF SOUNDER – If OFF option is set, the sounders in the system will not be activated in case of activation of the gas detector. If ON option is set, the sounders in the system will be activated in case of activation of the gas detector. OFF option is set by default.

All set parameters are confirmed with ENTER button. The exit to the main screen of DEVICES SETUP menu is with pressing CANCEL button.

Table 3. Activation types – Parameters Setting:

Activation type	Parameter Settings							
	Loop No	Group No	Zone No	Alarm Count	Device No	Input No*	Logic	Behavior
Device	1/2	-	-	-	1 - 250	1 - 4	-	Latched/ Unlatched
Input group	-	1 - 9	-	-	-	-	AND/OR	Latched/ Unlatched
Fire zone	-	-	1 - 48	1-9	-	-	-	Latched
Fire zone group	-	1 - 9	-	-	-	-	AND/OR	Latched
FIRE (common)	-	-	-	-	-	-	-	Latched
Fault zone	-	-	1 - 48	-	-	-	-	Latched/ Unlatched
Fault zone group	-	1 - 9	-	-	-	-	AND/OR	Latched/ Unlatched
FAULT (common)	-	-	-	-	-	-	-	Latched/ Unlatched
Fault system	-	-	-	-	-	-	-	Latched/ Unlatched
Pre alarm zone	-	-	1 - 48	-	-	-	-	Latched/ Unlatched
DISABLE (common)	-	-	-	-	-	-	-	Latched/ Unlatched
Sounder on	-	-	-	-	-	-	-	Latched/ Unlatched
Reset	-	-	-	-	-	-	-	Unlatched
Evacuate	-	-	-	-	-	-	-	Latched
Silence buzzer	-	-	-	-	-	-	-	Latched/ Unlatched
Silence alarm	-	-	-	-	-	-	-	Latched/ Unlatched
Test	-	-	-	-	-	-	-	Latched/ Unlatched
Evacuation Zone Group	-	1 - 9	-	-	-	-	AND/OR	Latched
Voice Cycle	-	-	-	-	-	-	-	Unlatched
Sounder ON (zonal)	-	-	1 - 48	-	-	-	-	Latched/ Unlatched

* For input/ output module only.

7.4. Addressing Menus

Attention: The addressing menus are available only from access level 3!

This menu allows the installer to set or change the device address or to perform self-addressing or auto-addressing procedure. The type of addressing depends on the installer's preferences and the system capacity and configuration.

The installer can use the following approaches for adding devices to the system configuration:

- The devices are directly connected to the panel Loop 1 and/ or Loop 2. The panel will recognize them and gives automatically addresses according the order of the devices in the line. The panel will start with the first free address in the system configuration. The installer can SAVE the new devices one-by-one or all at the time from the Menu 3. DEVICES SETUP.

- **SELF ADDRESSING.** The new devices are prepared for connection to the system configuration - the loop line is ready but the devices are not installed (the detectors and sounders are not mounted to the bases, the call points and modules are not connected to the loop). The installer enters 4. Addressing - 4.3. Self addressing menu. The panel shows the first free address for every of the loops. Now the installer can start mounting detectors and modules one by-one. The panel will set the displayed address number to the mounted device and automatically proceeds with next free address in the system.

- **AUTO ADDRESSING.** The auto addressing feature of SIMPO panel has the purpose to make the installation of the addressable systems easier. By using it the installer could mount all devices without setting address and then do it automatically by a single click in the panel. There are two main ways for auto addressing: by ID number of the devices, and by isolators.

- **Auto Addressing by ID Numbers.** The addressing procedure follows the order of the ID numbers of the devices connected to the line. The order is according the device type starting with fire detectors, sounders, call points and modules at the end.

- **Auto Addressing by Isolators.** This way requires all of the devices connected to the line to have a built-in or connected to the loop isolator module. The panel starts automatically setting address to the devices in increasing order from 1 to 250 by following the sequence of their position on the line.

The direction of auto-addressing procedure, according the positive and negative lines of the SIMPO TTE Loop expander, is shown on the next connection diagram:

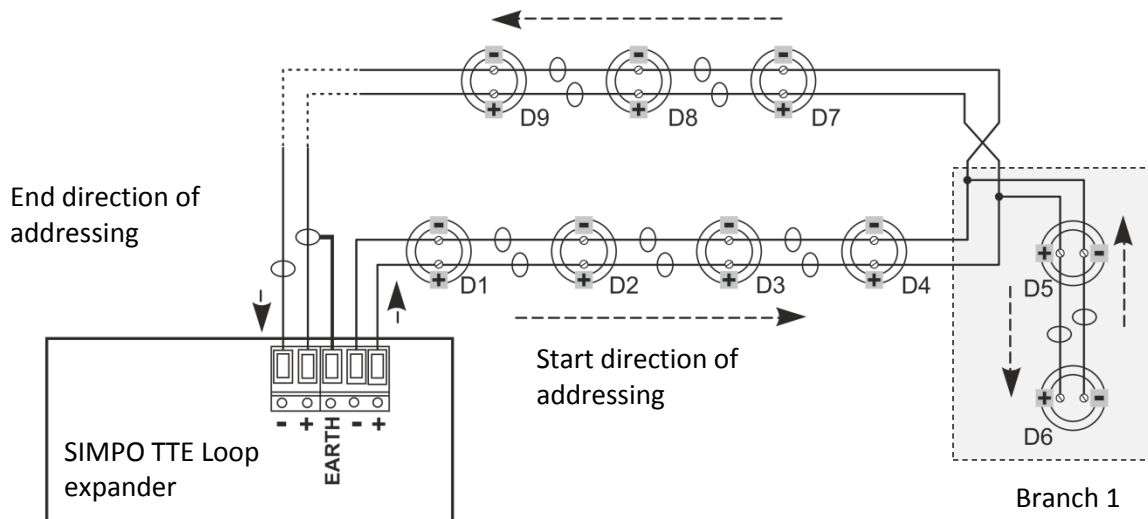

During the auto-addressing procedure the panel begins to address the devices in the loop one-by-one starting from right positive and negative lines of SIMPO TTE Loop following the direction to the right. The addresses in the possible branches on the loop continue the address numbers from the main line to the end of the branch. Then the address numbering continues on the main line and so on.

7.4.1 Set Address

In this submenu the installer can directly set addresses to new devices in the system. The procedure is same with that for self addressing. It is suitable when the installer needs to add single devices to the system configuration at free addresses. The detectors and sounders must not be mounted to the bases; the call points and modules must not be connected to the loop.

To set address to a device, enter in the installer's menu - 4. ADDRESSING - 4.1. SET ADDRESS. The device must be prepared for connection to the panel (loop 1 or loop 2).



The system automatically shows the first address in the system. Use the button 'CHANGE' to switch to loop 2 if present in the system. **The address is free if 'SAVE' button is active.**

To find a free address use the up and down arrows to scroll over the address numbers.

The free address in the system configuration is recognized with active 'SAVE' functional button (2) in the last row of the screen. Take the new device and connect it to the system - mount the detector or siren to the base or connect the module to the loop. Press the 'SAVE' button and wait for a couple of seconds. If the addressing is successful the message 'SUCCESSFUL' starts blinking on the screen. If the message is 'ERROR' then there is a problem - the device is not properly connected; there is no communication with the panel. You can proceed with setting the next address or escape with 'CANCEL' button.

7.4.2 Change Address

In this submenu the installer can change the address number of a device. To change address of a device, enter in the installer's menu - 4. ADDRESSING - 4.2. CHANGE ADDRESS.

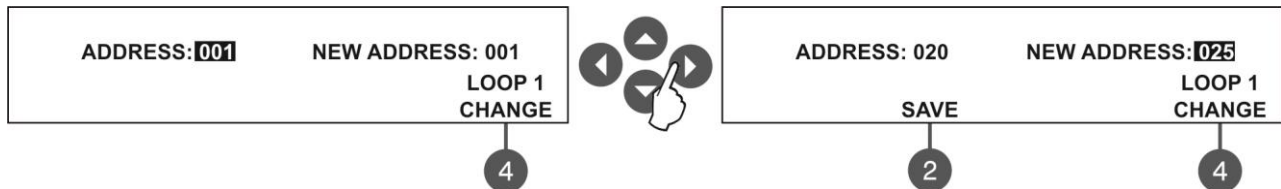

The system automatically shows the first address in the system. Use the up and down arrows to select the address of the device you want to change.

Use the button 'CHANGE' to switch to loop 2 if present in the system.

Press the right arrow button to switch to 'NEW ADDRESS' field.

Press right arrow button to move to field 'NEW ADDRESS'.

Use again the up and down arrows to find a free address in the system configuration - the active 'SAVE' functional button (2) in the last row of the screen will appear. Press the 'SAVE' button and wait for a couple of seconds. If the address changing is successful the message 'SUCCESSFUL' starts blinking on the screen. You can proceed with changing other address or escape with 'CANCEL' button.

7.4.3 Self-Addressing

In this submenu the installer can perform self addressing procedure of devices to the system configuration. The self addressing procedure is suitable when there are great amount of devices to be connected to the panel.

The new devices are prepared for connection to the system configuration - the loop line is ready but the devices are not installed (the detectors and sounders are not mounted to the bases; the call points and modules are not connected to the loop).

To perform self addressing, enter in the installer's menu - 4. ADDRESSING - 4.3. SELF ADDRESSING. The panel shows the first free address for every of the loops. Now the installer can start mounting detectors and modules one by one. The panel will set the displayed address number to the mounted device and automatically proceeds with next free address in the system.

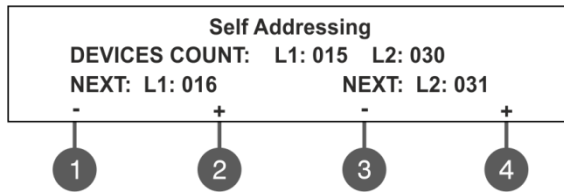

The self-addressing menu shows information about the total number of devices connected to every loop.

On the third row the panel shows the first free address for every of the loops. The panel skips all already set address numbers and will jump to the next free address number.

The installer also can set manually the next address using the functional buttons from 1 to 4. The '-' will decrease the address

number and the '+' will increase it. If by mistake the set address is not free, during the self-addressing procedure the panel will skip it and will jump to the next free address number.

In self-addressing mode the panel waits for connecting the device to the loop, automatically sets the current address to the device and moves to the next free address number. With every one added device to the system configuration the address count will increasing to show the total number of devices connected to the respective loop.

The exit of the menu is with pressing the 'CANCEL' button.

IMPORTANT NOTES!



1. During the self addressing procedure leave minimum 10 sec time interval between connecting the next device to the loop.
2. NEVER connect devices to both loops at the same time. Connect all devices to loop 1 first and after that proceed with loop 2.
3. After completing the self addressing procedure test the devices with LED indication on.

7.4.4 Auto-Addressing

The auto-addressing is a convenient and fast method for addressing devices during the initial startup or in case of full reconfiguration of the whole system.

All devices should be connected to the loop controllers of the panel. **In case of using the procedure of addressing by isolator, is obligatory to use detectors and sounders with built-in isolator, and all other devices – modules and call points – with connected isolator to the loop.**

Note: The modules SensoIRIS MC-D and SensoIRIS MINP, and SensoIRIS GAS Detector have no built-in isolator! If they are included in the loop configuration the installer should use auto-addressing by ID numbers procedure!

To start the auto-addressing procedure, choose in sequence - menu 4. ADDRESSING – submenu 4.4. AUTOADDRESSING. After entering the menu the installer can choose the method of addressing and the loop number.

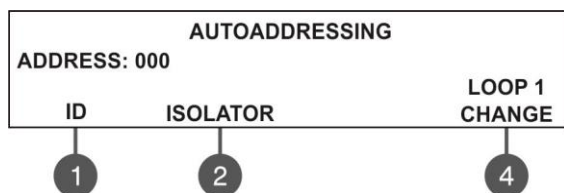

Use the functional buttons to choose the method for auto-addressing:
(1) ID – The addressing procedure follows the order of the ID numbers of the devices connected to the line. The order is according the device type starting with fire detectors, sounders, call points and modules at the end.

(2) Isolator - This way requires all of the devices connected to the line to have a built-in or connected to the loop isolator module. The

panel starts automatically setting address to the devices in increasing order from 1 to 250 by following the sequence of their position on the line. During the auto-addressing procedure the panel begins to address the devices in the loop one-by-one starting from right positive and negative lines of SIMPO TTE Loop following the direction to the right.

(4) CHANGE – Use the button the select the loop number where the selected auto-addressing procedure is applied.

7.5. Panel Outputs Menus

This menu allows the installer to disable/ enable and to set time delay for some of the outputs of the control panel:

- Sounder Outputs (SND 1, SND 2)
- Extinguish Output (EXT)
- Fire Output (FIRE)
- Fault Output (FAULT)
- Four Relay Outputs

The menu is accessible from access levels 2 and 3.

To set outputs parameters, enter in the installer's menu - 5. PANEL OUTPUTS. The submenus are allocated in two screens.

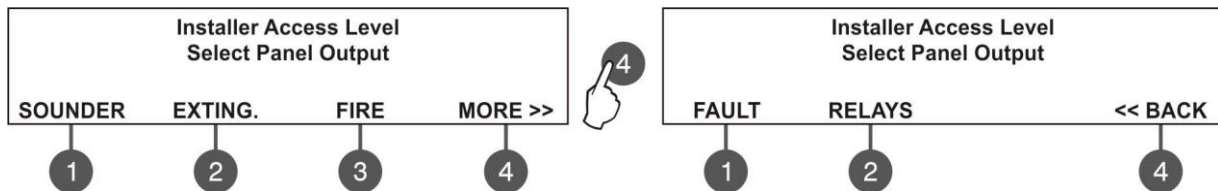

7.5.1 Sounders Outputs

In this submenu the installer can disable/ enable the sounders activation and the time delay operation. To access the SOUNDER submenu, enter in the installer's menu - 5. PANEL OUTPUTS - SOUNDER (1).

Attention: In access level 2 you can only review the set delay status (ON, OFF, SCHEDULE), with no rights to change it!

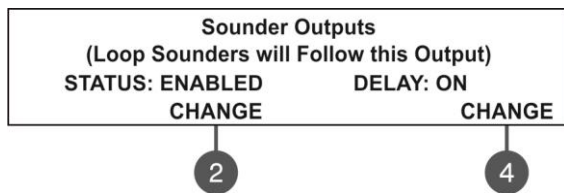

The functional buttons have the following action:

- (2)** - Press to change the status of the sounder outputs. Every pressing of the button changes alternatively the ENABLED - DISABLED status. When the sounder outputs are disabled the LEDs 'Sounder Output Fault/ Disable' and 'Disable' light on permanently.
- (4)** - Press to set the time delay operation. Every pressing of the button changes the 'Delay' setting:

- **ON** - The delay of sounder outputs will be active when DAY operation mode is set - see the description for menu 6.3 DAY/ NIGHT operation modes.
- **OFF** - No delay of sounder outputs activation. The sounder outputs are activated immediately.
- **SCHEDULE** - The delay of sounder outputs will be active on schedule - see the description for menu 6.3 DAY/ NIGHT operation modes.

All set parameters are confirmed with ENTER button.

7.5.2 Extinguishing Output

In this submenu the installer can disable/ enable the extinguish output activation. To access the EXTINGUISH submenu, enter in the installer's menu - 5. PANEL OUTPUTS – EXTING. (2).

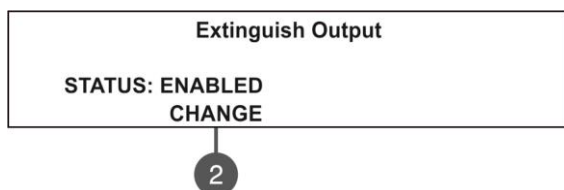

The functional button has the following action:

- (2)** - Press to change the status of the extinguish output. Every pressing of the button changes alternatively the ENABLED - DISABLED status. When the extinguish output is disabled the LED "Disable" light on permanently.

All set parameters are confirmed with ENTER button.

7.5.3 Fire Output

In this submenu the installer can disable/ enable the fire output activation and the time delay operation. To access the FIRE submenu, enter in the installer's menu - 5. PANEL OUTPUTS - FIRE (3).

Attention: In access level 2 you can only review the set delay status (ON/ OFF), with no rights to change it!

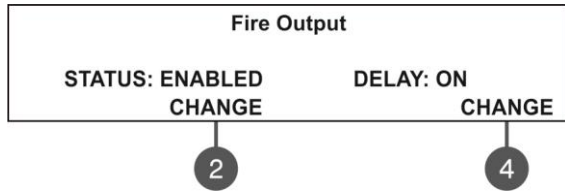

The functional buttons have the following action:

(2) - Press to change the status of the fire output. Every pressing of the button changes alternatively the ENABLED - DISABLED status. When the fire output is disabled the LEDs 'Fire Output Fault/ Disable' and 'Disable' light on permanently.

(4) - Press to set the time delay operation. Every pressing of the button changes the 'Delay' setting:

- **ON** - The delay of fire output will be active when DAY operation mode is set - see the description for menu 6.3 DAY/ NIGHT operation modes.
- **OFF** - No delay of fire output activation. The fire output is activated immediately.
- **SCHEDULE** - The delay of fire output will be active on schedule - see the description for menu 6.3 DAY/ NIGHT operation modes.

All set parameters are confirmed with ENTER button.

7.5.4 Fault Output

In this submenu the installer can disable/ enable the fault output activation.

To access the FAULT submenu, enter in the installer's menu - 5. PANEL OUTPUTS – MORE> (4) – FAULT (1).

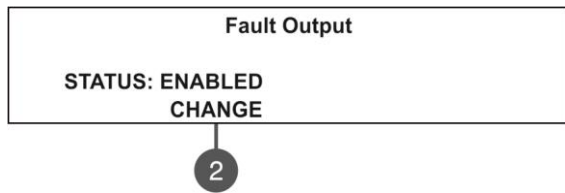

The functional button has the following action:

(2) - Press to change the status of the fault output. Every pressing of the button changes alternatively the ENABLED - DISABLED status. When the fault output is disabled the LED 'Disable' light on permanently.

All set parameters are confirmed with ENTER button.

7.5.5 Relay Outputs

Attention: The relay outputs are available for setting parameters only from access level 3!

In this submenu the installer can the set parameters of the relay outputs on the control panel PCB.

To access the RELAY OUTS submenu, enter in the installer's menu - 5. PANEL OUTPUTS - MORE>> - RELAYS (2).

Attention! The order of the relay numbers follows that on the control panel PCB!

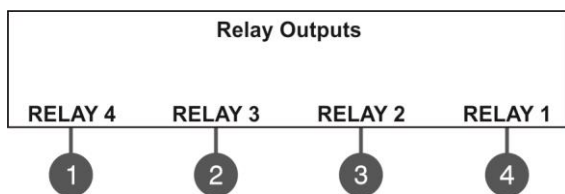

The programming of the relay outputs is analogical.

Use the functional buttons to set parameters for:

- 1 - Press to set parameters for RELAY 4
- 2 - Press to set parameters for RELAY 3
- 3 - Press to set parameters for RELAY 2
- 4 - Press to set parameters for RELAY 1

For the settings of the relay outputs refer to the description of the menus for SensoIRIS MIO-04.

All set parameters are confirmed with ENTER button.

The exit to the main screen of PANEL OUTPUTS is with pressing the CANCEL button.

7.6. General Settings Menu

This menu allows the installer to make some common settings for the fire panel. The menu is accessible from access levels 2 and 3, as for the level to be introduced some restrictions.

A list with submenus is displayed after entering the installer's menu - 6. GENERAL SETTING. The currently selected submenu is blinking. To enter into a submenu press 'ENTER'.

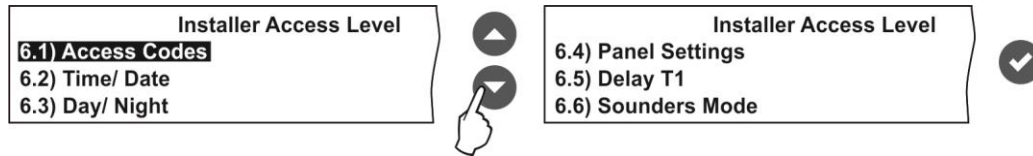

7.6.1 Access Codes

Attention: The access codes can be changed only from access level 3!

In this submenu the installer can change the code combinations for access to INSTALLER and MAINTENANCE levels. To access the ACCESS CODES submenu, enter in the installer's menu - 6. GENERAL SETTING - 6.1) ACCESS CODES.

The screen displays the supported submenus and the current set access code for the INSTALLER and MAINTENANCE programming menus:

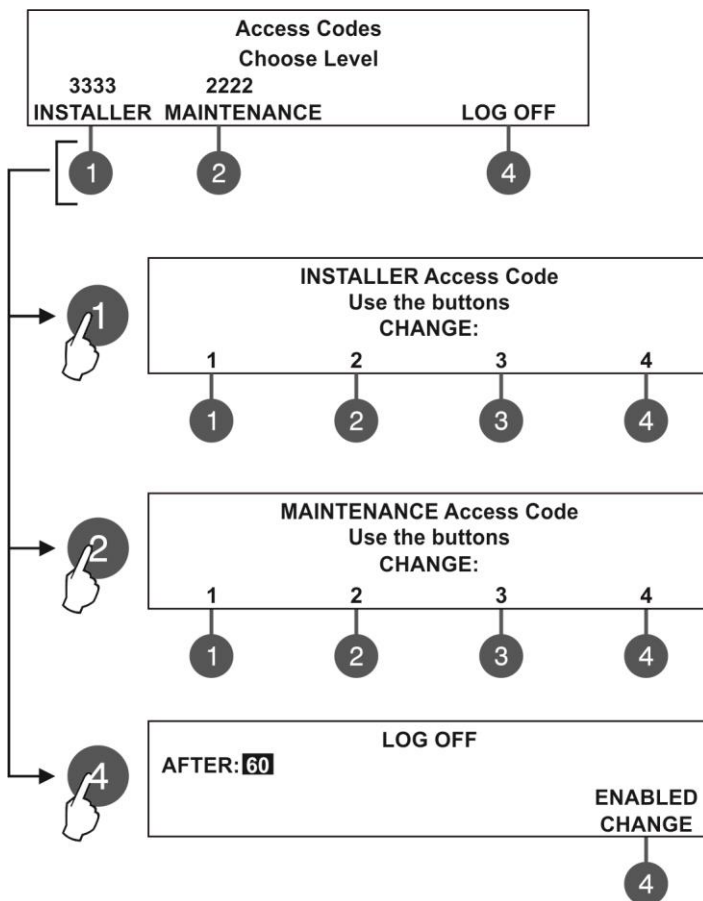

The settings are analogical for both levels.

Use the functional buttons to set access code for:

- (1) - Press to change INSTALLER CODE
- (2) - Press to change MAINTENANCE CODE
- (3) - Press to enter a submenu for setting time for automatic exit from the INSTALLER and MAINTENANCE menus.

Use the functional buttons to enter new 4-digit INSTALLER code combination. The system will ask to confirm the change. The exit is automatic to Access Level main screen.

The default INSTALLER code is 3333.

Use the functional buttons to enter new 4-digit MAINTENANCE code combination. The system will ask to confirm the change. The exit is automatic to Access Level main screen.

The default MAINTENANCE code is 2222.

In field „AFTER“ enter time from 0 up to 60 minutes for automatic exit from the INSTALLER and MAINTENANCE programming menus.

Use button (4) CHANGE to set the status:

- *ENABLED* – The automatic exit is enabled.
- *DISABLED* – The automatic exit is disabled.



If the installer's access code is changed and obscured you have to perform a hardware reset of the panel settings!

7.6.2 Setting the Date and Time

Attention: The setting of the date and time is available only from access level 3!

In this submenu the installer can set the current time and date for the panel.

To access the TIME/ DATE submenu, enter in the installer's menu - 6. GENERAL SETTING - 6.2) TIME/ DATE. The screen displays:

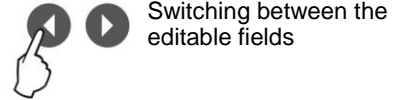
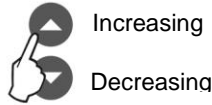
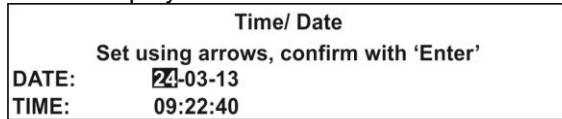

The editable field is blinking. Use the up and down arrows to set the date and time. Use the left and right arrows to switch over the editable fields.

IMPORTANT NOTES!
 The SIMPO panel is equipped with built-in battery for saving the set time and date in case of main or back-up power supply lost.
 Put a jumper on JP7 terminals on the control panel PCB to enable the built-in battery and saving the set time and date.

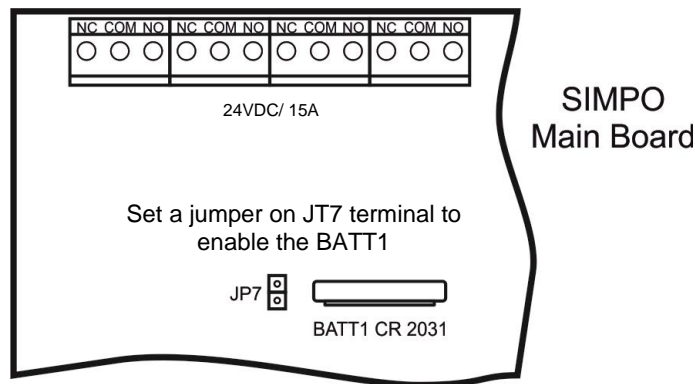

7.6.3 Setting Day/ Night Alarm Modes

In this submenu the installer can set the operation alarm mode of the panel.

To access the DAY/ NIGHT submenu, enter in the installer's menu - 6. GENERAL SETTING - 6.3) DAY/ NIGHT. The screen displays:

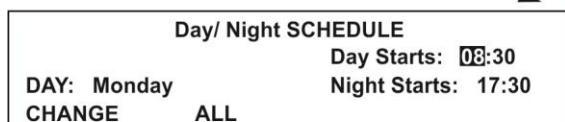
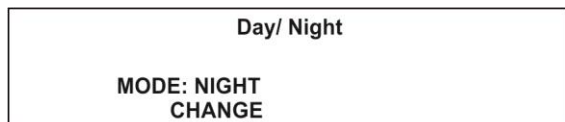

Press the functional button '2' to select the preferred alarm mode:
NIGHT - Select to set nighttime alarm mode. The devices will operate only in night alarm mode.
DAY - Select to set daytime alarm level. The devices will operate only in day alarm mode.
SCHEDULE - Select to set operation on a schedule. The devices will operate on the programmed schedule.

The schedule is set in DAY/ NIGHT SCHEDULE submenu - press functional button '4'.

In DAY/ NIGHT SCHEDULE submenu the installer can define the day and night time intervals for all days of the week. The current editing value is blinking.

- (1) DAY CHANGE** - Press to change the day of the week. Use the up and down arrows to set the day and night time intervals for the day. Use the left and right arrows to switch over the editable fields.
 - (2) ALL** - Press to set the current set day and night time intervals for all days of the week.
- Confirm all settings with pressing ENTER button.

7.6.4 Panel General Settings

In this submenu the installer can make some adjustments for the panel performance.

To access the PANEL SETTINGS submenu, enter in the installer's menu - 6. GENERAL SETTING - 6.4) PANEL SETTINGS. The screen displays:

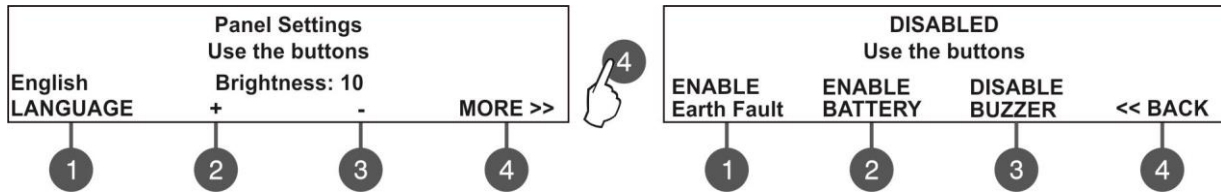

(1) LANGUAGE - Press to set the language. Every pressing of the button changes the currently used language for the menus.

(2) + Brightness - Press to increase the brightness of the screen back light. The maximum value is 20.

(3) - Brightness - Press to decrease the brightness of the screen back light. The minimum value is 0.

(4) MORE>> - Press to switch to other panel settings. Confirm all settings with pressing ENTER button.

(1) Earth Fault - Press to enable/ disable the Earth Fault indication. When the Earth Fault indication is enabled you have to set a jumper to Earth Fault terminals on the control panel PCB.

(2) BATTERY - Press to enable/ disable the Accumulator Battery Fault Indication. When the Accumulator Battery Fault Indication is enabled the panel will monitor the internal battery resistance R_i . In normal operation $R_i < 0.3\Omega$. If $R_i > 0.3\Omega$, the panel will alert for Battery fault with message in Faults menu 'Battery High Resistance'. The installer has to change the accumulator battery with new.

(3) BUZZER - Press to enable/ disable the buzzer signalization.

(4) << BACK - Press to switch back to previous settings. Confirm all settings with pressing ENTER button.

7.6.5 Delay T1

In this submenu the installer sets the time to Delay T1. T1 is the time delay needed for reaction of the security personnel on the protected site. T1 provides a time delay for the personnel to go to the zone in fire alarm and to check the situation. The operation of time delays T1 and T2 are described with the algorithm below.

To access the DELAY T1 submenu, enter in the installer's menu - 6. GENERAL SETTING - 6.5) DELAY T1. The screen displays:

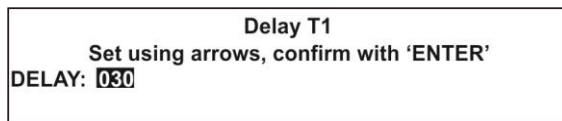

Use the up and down arrows to set the delay T1. The time interval is in range 0 - 60 sec.

Confirm the settings with 'ENTER' button.

7.6.6 Sounders Mode

In this submenu the installer sets the sounders operation mode.

To access the SOUNDERS MODE submenu, enter in the installer's menu - 6. GENERAL SETTING - 6.6) SOUNDERS MODE. The screen displays:

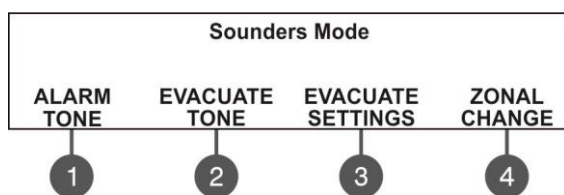

Use the functional buttons to set:

(1) ALARM TONE* – Set the alarm type sound. Enter the submenu and use the up/ down arrow buttons to select a number from 1 to 32 for the alarm sound – the reference parameters for the selected sound are listed on the last row of the screen.

(2) EVACUATE TONE* – Set the evacuation type sound. Enter the submenu and use the up/ down arrow buttons to select a number

from 1 to 32 for the evacuation sound – the reference parameters for the selected sound are listed on the last row of the screen.

* **Note:** The main tone type for SensolRIS sounders is 27 with main sound frequency 2500Hz.

(3) EVACUATE SETTINGS – Press it to make the following evacuation settings for sounders operation.

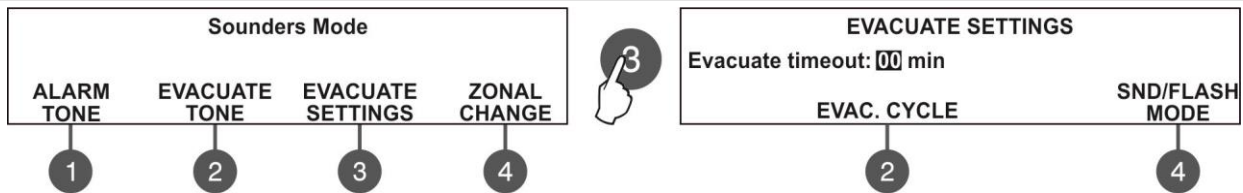

Press the **(3) EVACUATE SETTINGS** button to enter into the menu for setting a time delay - *EVACUATE TIMEOUT*. When introduced, in case of event, this time delay starts running until the real evacuation of the site, i.e. this is a pre-alarm operation mode. Use the up/ down arrow buttons* to set the EVACUATE TIMEOUT delay from 0 to 10 minutes. In a fire situation only the sounder of the zone(s) with alarm condition will be activated.

Use the **(2) EVAC.CYCLE** button to set a cycle sounding of the sounders in evacuation mode.

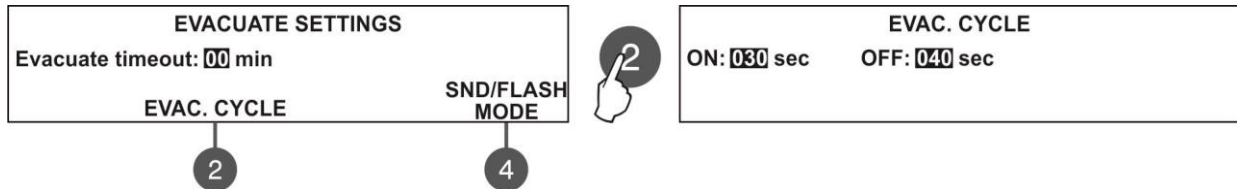

The function requires setting of two special times defining time intervals for sounders operation as follows:

- **ON** – Set this time interval from 1 to 600 seconds*. During evacuation mode the sounders will operate with the setting of (4) MORE button described above – for example when SND/FLASH option is set the sounders will sounding and flashing at the same time (for the models available).
- **OFF** - Set this time interval from 1 to 600 seconds*. During evacuation mode the sounders will operate only in FLASH mode (for the models available).

* Use the up and down arrow buttons to set the parameter value; use the left and right arrow buttons to switch between the two parameters.

ATTENTION: The EVAC. CYCLE function is active only when the ON and OFF times are set different from 0. If one or both times are set to 0 the function is inactive.
 For example: The *MODE* is set to *SND/FLASH* and the *EVAC. CYCLE TIMES* are set *ON: 030 sec* and *OFF: 040 sec*. When Evacuation is in process on the protected site the operation of the system according the *EVACUATION SETTINGS* will be the following: The sounders will sound (Evacuation tone) and flash for 30 seconds and then will only flash for 40 seconds. The cycle will repeat until resetting of the system or pressing the Silence Alarm button.

After the set evacuation timeout delay is over the sounders in the whole site are activated also, according the settings of the **(4) MODE** button in this menu:

Use the (4) **MODE** button to set the action of the sounders:

- **SND/FLASH** – The addressable sounders are activated with sound and LED indication. The sounder outputs on the panel PCB are activated also.
- **SND** – The addressable sounders are activated with sound indication only. The sounder outputs on the panel PCB are activated also.
- **FLASH** - The addressable sounders are activated with LED indication only. The sounder outputs on the panel PCB are not activated.

The last functional button in 6.6) **SOUNDERS MODE** is used for choosing the sounders operation mode.

(4) ZONAL CHANGE – Press to change the sounders operation mode.

- **Common** - All sounders will be activated with no sense of zone to which they are connected.
- **Zonal** - Only the sounder of the zones with alarm condition will be activated.

7.6.7 Company Logo

Enter company name and site description using the arrow buttons as described in APPENDIX B. The description can be entered on 2 rows with up to 40 symbols (including spaces) each. To enter symbols and letters use the buttons with up and down arrows. The cursor is moved with the left and right arrow buttons. After entering the full system name and information for the site, press "ENTER" button to save it. See also APPENDIX B.

7.7. Save Configuration Menu

Attention: Saving the system configuration is available only from access level 3!

In this menu the installer performs saving of the new found devices in the system configuration. The panel will ask for confirmation of the action. The screen displays.

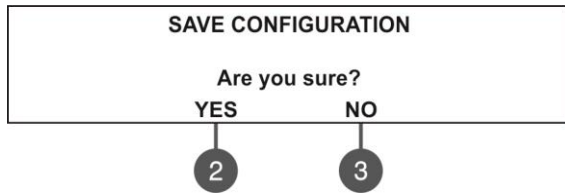

Use the functional buttons to confirm or reject the save configuration. You can also escape from this menu with 'CANCEL' button.

7.8. Restore Defaults Menu

Attention: The restore defaults menu is available only from access level 3!

In this menu the installer performs reset to default settings of the system configuration. The panel will ask for confirmation of the action. The screen displays.

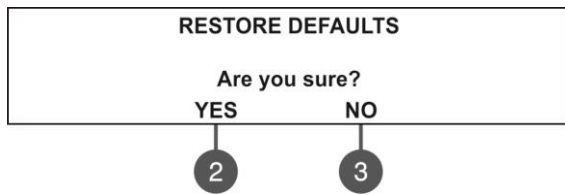

Use the functional buttons to confirm or reject the restore defaults settings. You can also escape from this menu with 'CANCEL' button.

7.9. Software Revision

In this menu the installer can review the software versions of the main board and used loop modules and also has possibility for firmware update of the main processor unit. The screen displays:

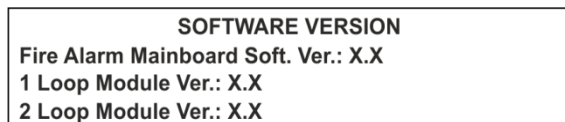

7.10. Network

(supported for Soft. Revision 2.8 and higher)

In this menu the installer can make the settings for the redundant network between fire panels.

7.10.1 Network Settings

To access the NETWORK settings, enter in the installer's menu - 10. NETWORK – 10.1) SETTINGS. The screen displays:

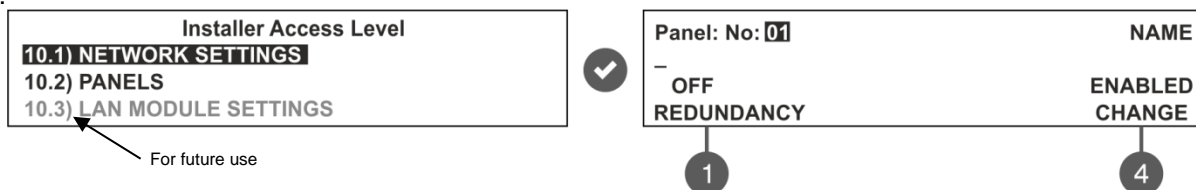

In this submenu the installer enters a number, name and sets the status of the panel in the redundant network. Use the up/ down arrow buttons to set the panel number. Move on the second row with right arrow button and enter a specific name up to 40 symbols, including intervals.

(1) – REDUNDANCY - Use the button to set an option for ignoring a fault message for broken connection in the redundant network. Set OFF if you do not want to monitor the status of the connection in the redundant network; set ON if you want to monitor the continuity of the redundant network.

(4) – CHANGE - Use the button to set the status of the panel in the redundant network - ENABLED (the panel is enabled for operation in the network) / DISABLED (the panel is disabled for operation in the network). When the panel is DISABLED from the network it will not receive messages from other panels and will be visualized as FAULT. Confirm the setting with 'ENTER' button. You can also escape from this menu with 'CANCEL' button.

7.10.2 Panels Settings

To access the PANELS settings, enter in the installer's menu - 10. NETWORK – 10.2) PANELS.

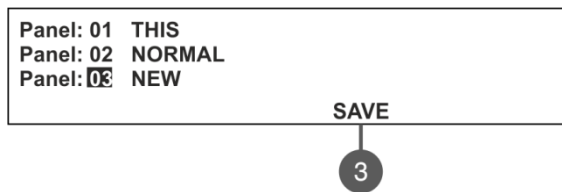

On the screen are listed the panels with their current state in the redundant network:

- **NEW** – The panel is new in the system. To save it press button (3) SAVE.
- **NORMAL** – The redundant network for the panel is enabled.
- **THIS** – The panel from which the redundant network is reviewed.
- **FAULT** – The panel is DISABLED or there is problem with the redundant network.
- **NONE** – No panel connected to the redundant network.

All new panels connected to the redundant network can be saved with (3) SAVE button. The panels with current state NORMAL, THIS and FAULT can be deleted from the network with (3) REMOVE button.

If a new panel enabled in the network is with number already set for another panel the “GENERAL FAULT” LED will lights on and a message for fault event “Double Panel number” is generated. The installer should change the doubled panel number for proper operation in the redundant network.

For every panel the installer can set individually the panel's activity to Receive/ Send messages and/ or commands.

The settings for sending commands can be done only for THIS panel (current panel).

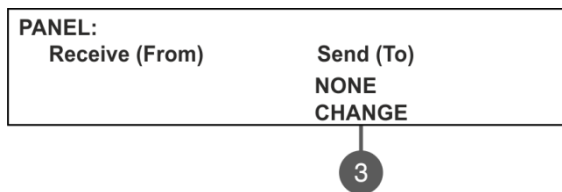

Use the (3) CHANGE button to set the options:

- **NONE** – The panel cannot send any commands to other panels in the redundant network.
- **COMMANDS** – The panel can send commands to other panels in the redundant network.

The settings for receiving commands can be done for all other panels.

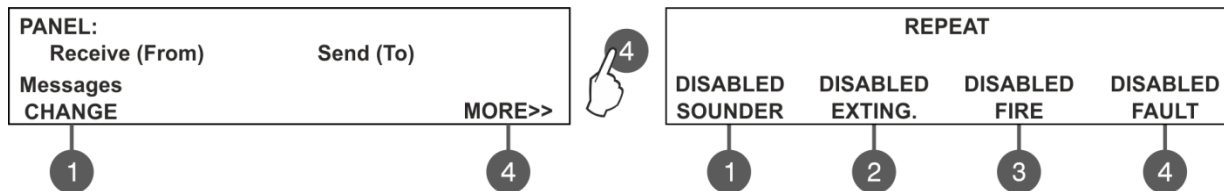

Use the (1) CHANGE button to set the options:

- **NONE** - The panel will not receive any data from the other panels in the redundant network.
- **MESSAGES** - The panel will receive only messages from other panels in the redundant network.
- **COMMANDS** - The panel will receive only commands from other panels in the redundant network.
- **MESSAGES & COMMANDS** - The panel will receive commands and messages from other panels in the redundant network.

Use the (4) MORE button to choose the activation of the outputs of the panel – for those cases when the alarm event is reported from a panel connected to the network. In the REPEAT screen enable the outputs of the panel for repeating. The repeating of the output is enabled/disabled with pressing the button. All of the outputs are disabled for repeating by default. At the end press “ENTER” button to save the settings.

7.11. Active Isolators Menu

This is an information menu for reviewing the active isolators (built-in isolator in SensorIS devices).
The active isolators in the system are displayed as device addresses in the fields “L1” and “L2” for SIMPO loops.

ACTIVE ISOLATORS	
L1:	
L2:	

7.12. Access Level 1

Exit from Access Levels 2 and 3 to Access Level 1.

After choosing the menu with button ENTER, the panel automatically returns to Access Level 1. To enter in Access Level 2 (Maintenance) and Access Level 3 (Installer) again, the user has to enter a valid code for the respective access level.

APPENDIX A

Table: Event Messages.

Message	Description
Flash Error	FLASH Memory error is detected.
Ram Error	RAM Memory error is detected.
New Periphery Devices Found	New periphery devices are found in the system configuration.
Periphery Device Fault	The device is not responding (the device is lost or failed).
Periphery Device Type Error	A periphery device with different type is found on the address.
AC Loss	The main power supply is lost.
Battery Low	The accumulator battery is discharged.
Battery Loss	The accumulator battery is missing.
Battery High Resistance	High value ($R_i > 0.3\Omega$) of the battery internal resistance. Replace the battery immediately!
Earth Fault	Resistive connection between some signals and earth $< 10k$.
Charger Fault	The charging unit is failed.
Sounder1 Short	Short circuit detected at Sounder 1 output.
Sounder2 Short	Short circuit detected at Sounder 2 output.
Sounder1 Open	Circuit broken at Sounder 1 output.
Sounder2 Open	Circuit broken at Sounder 2 output.
Fire Output Short	Short circuit detected at Fire output.
Fire Output Fault	Circuit broken at Fire output.
EXT Output Short	Short circuit detected at Extinguishing output.
EXT Output Fault	Circuit broken at Extinguishing output.
Fault Output Short	Short circuit detected at Fault output.
Fault Output Fault	Circuit broken at Fault output.
Fault Power AUX	Short circuit (the mains power supply is lost).
Alarm Confirm Input Short	Short circuit detected at input 'Alarm Confirmation'.
Alarm Confirm Input Open	Circuit broken at input 'Alarm Confirmation'.
Alarm Confirm Input On	'Alarm Confirmation' input activation.
Protection Alarm Confirm Short	Short circuit detected at input 'Protection Alarm Confirmation'.
Protection Alarm Confirm Open	Circuit broken at input 'Protection Alarm Confirmation'.
Protection Alarm Confirm On	'Protection Alarm Confirmation' input activation.
Fault Protection Panel Input Short	Short circuit detected at input 'Protection Panel Fault'.
Fault Protection Panel Input Open	Circuit broken at input 'Protection Panel Fault'.
Fault Protection Panel Input On	'Protection Panel Fault' input activation.
Protection Panel Fault	The extinguishing panel failure.
Loop Break	The loop is broken.
Loop Short	Short circuit detected in the loop.
New Loop Devices Found	New loop devices are found in system configuration (Loop 1 or Loop 2).
Loop Zero Address	There is a device without address number (a device with address 0 is applied).
Double Panel number	Doubling of the panel number (when two or more panels are connected in a network).
Panel Fault	Fault in the connection with another panel (when two or more panels are connected in a network).
Reset	Resetting of the panel.
Silence Alarm	The sounders have been silenced.
Zone Disabled	The zone is disabled.
Earth Fault function DISABLED	The Earth Fault indication is disabled.

Sounder Disabled	The Sounders are disabled.
Fire Brigade Output Disabled	The fire output is disabled.
Fire Protection Output Disabled	The extinguishing output is disabled.
Fault Output Disabled	The fault output is disabled.
Zone In Test	The zone is in test mode.
Transmitting device active	The Fire output is activated.
Extinguishing output active	The Extinguishing output is activated.
Sirens active	The sounders are activated.
User log off	Exit from access level 2 (Maintenance).
Installer log off	Exit from access level 3 (Installer).
User log on	Entry in access level 2 (Maintenance).
Installer log on	Entry in access level 3 (Installer).
High Resistance Disabled	The indication for high battery resistance is disabled.
Total loss of Power	Both main and backup power supply are lost (the main power supply is lost and the accumulator battery is fully discharged).
Buzzer Disabled	The internal buzzer is disabled.
Network Fault	Redundant network breakdown.
Loop Device Disabled	The loop device is disabled.
Chamber Fault	Fault in the detector.
Clean Me Now	Dirty detector chamber.
Loop Device Input Fault	Fault in loop device input.
Loop Device Output Fault	Fault in loop device output.
Alarm	Fire alarm signal from detector.
PreAlarm	Fire alarm signal from detector in 2DEVICES or DOUBLE operation mode for zone.
Test Alarm	Fire alarm signal from tested detector.
Loop Device Type Error	A different than the expected type of device has been detected at the address.
Loop Device Fault	The device does not respond (lost or damaged).
Double Address	More than one device with the same address in the loop.
Evacuate	Activated Call Point or EVACUATE button on the panel.
Log Fault	The Log file event is lost or damaged.
Gas Alarm	Activated gas detector SensolRIS GAS.
Power Supply Fault	Fault in the external power supply of conventional zone module SensolRIS MC-Z or gas detector SensolRIS GAS.
Panic	Panic alarm signal from detector.
Active Relay	Activated relay output of the panel. After the message is displayed also the number of the activated relay (1-4).
Loop Device Input Active	Activated input of a loop device. After the message is displayed the name of the input, loop number (L:), zone number (Z:), device address (D:), and at the end the input number, for example D:6.4 means that the address of the device is 6 and the input number is 4.
Loop Device Output Active	Activated output of a loop device. After the message is displayed the name of the output, loop number (L:), zone number (Z:), device address (D:) and at the end the output number, for example D:6.4 means that the address of the device is 6 and the output number is 4.
Activated Output	Activated output of the panel.
Redundant processor fault	Redundant processor is failed.

APPENDIX B

Table: Text and symbols for introducing device and zone names.

In device or zone name entering mode every pressing of up/ down arrow button changes the entered letter or symbol. When moving to the next new position the entering starts from the beginning of the table.

←	—	!	”	#	\$	%	&	'	()	*	+	,	-	.	/	0	1	2	3	4	5	
	6	7	8	9	:	;	<	=	>	?	@	A	B	C	D	E	F	G	H	I	J	K	
	L	M	N	O	P	Q	R	S	T	U	V	W	X	Y	Z	[]	^	_	`	a	
	b	c	d	e	f	g	h	i	j	k	l	m	n	o	p	q	r	s	t	u	v	w	
	x	y	z	А	Б	В	Г	Д	Е	Ж	З	И	Й	К	Л	М	Н	О	П	Р	С	Т	
	У	Ф	Х	Ц	Ч	Ш	Щ	Ъ	ь	Ы	Э	Ю	Я	а	б	в	г	д	е	ж	з	и	
	й	к	л	м	н	о	п	р	с	т	у	ф	х	ц	ч	ш	щ	ъ	ь	ы	э	ю	↘
↙	я																						

APPENDIX C

Initial power up of the system.

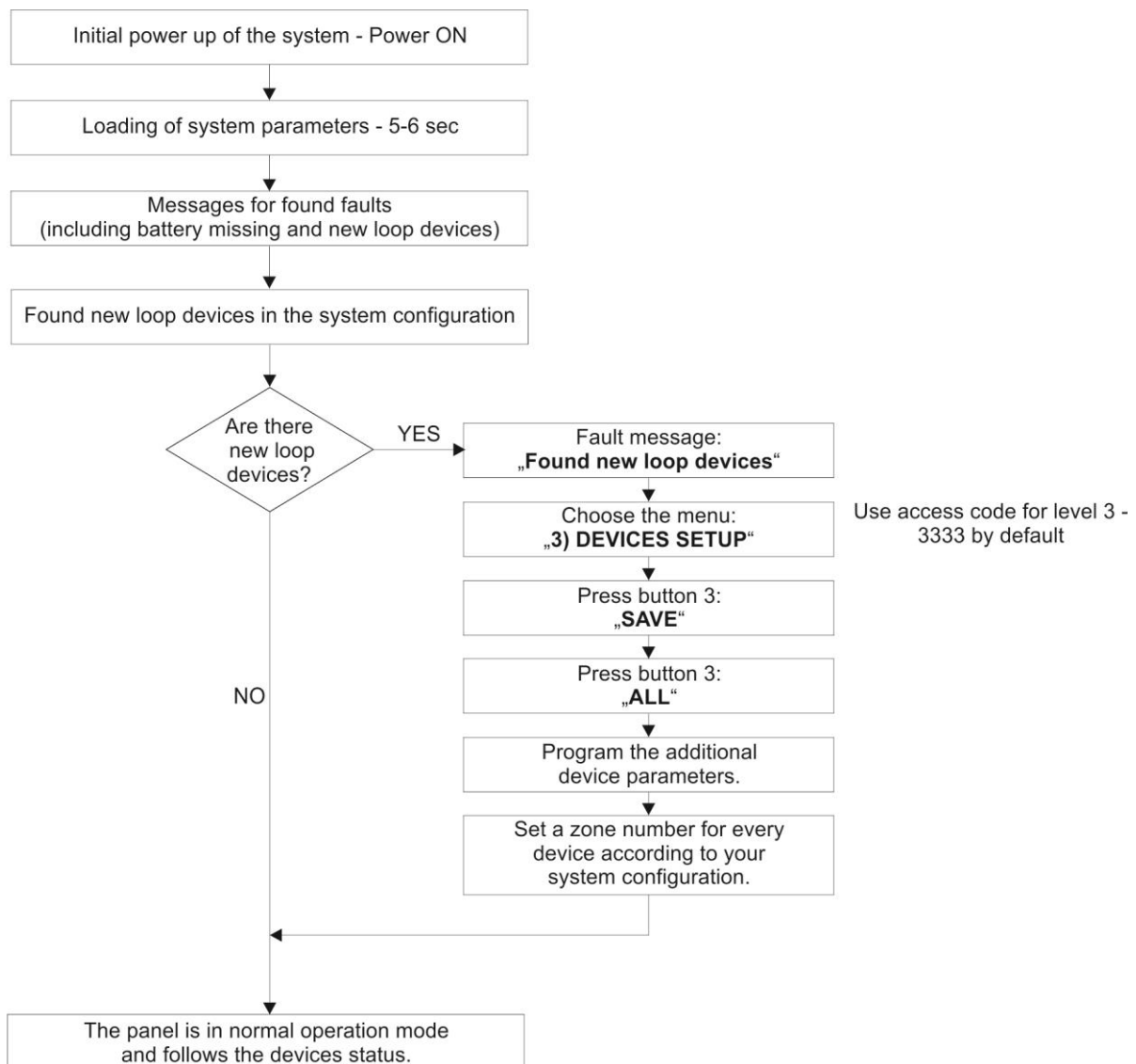

APPENDIX D

Two steps of alarming Algorithm.

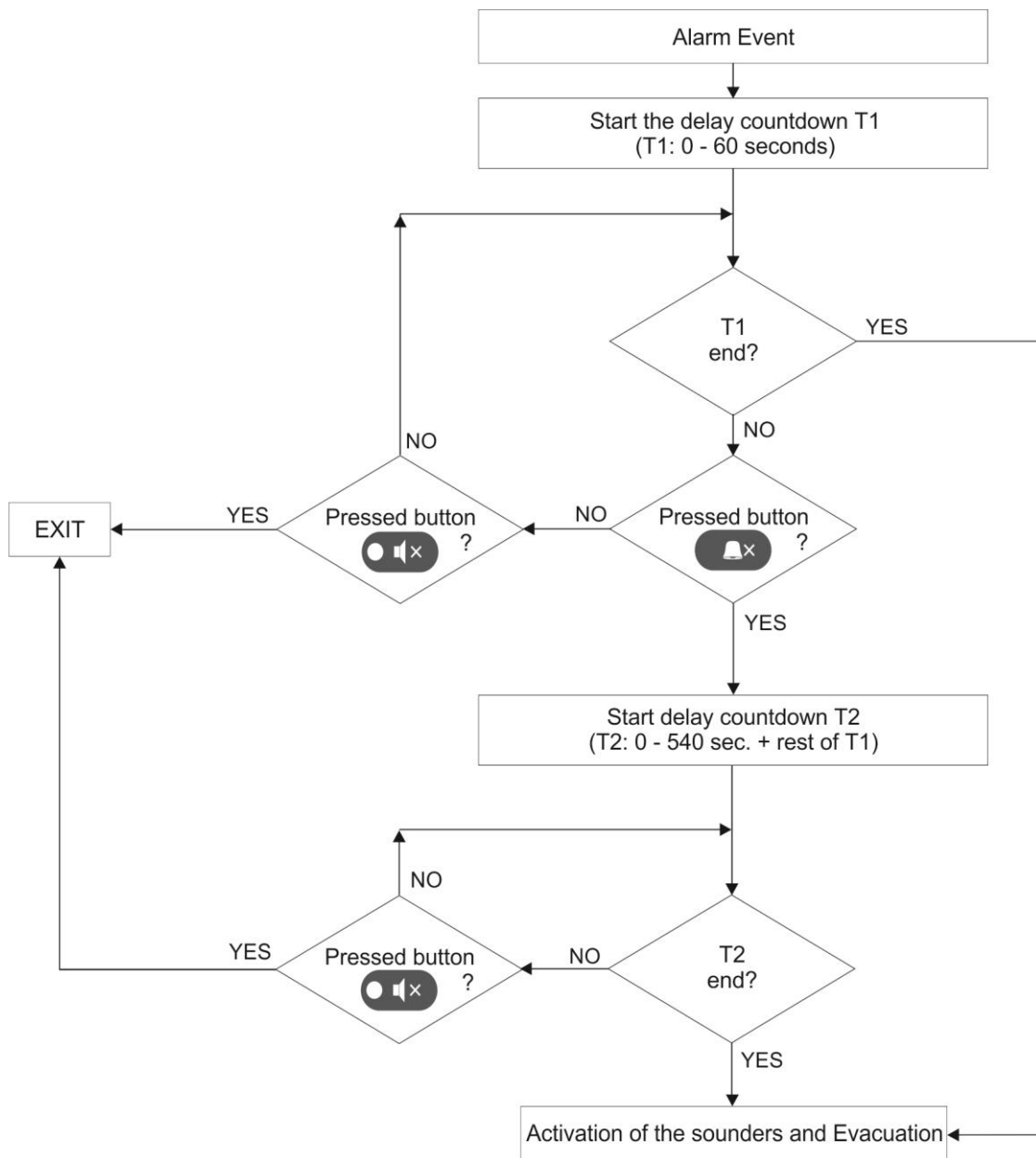

APPENDIX E

Tree structure of the programming menus.

The presented tree structure describes the full access to the programming menus from level 3 – Installer. From access level 2 – Maintenance, some of the programming menus are not displayed or the operation with them is partially limited – see also the Table on page 21.

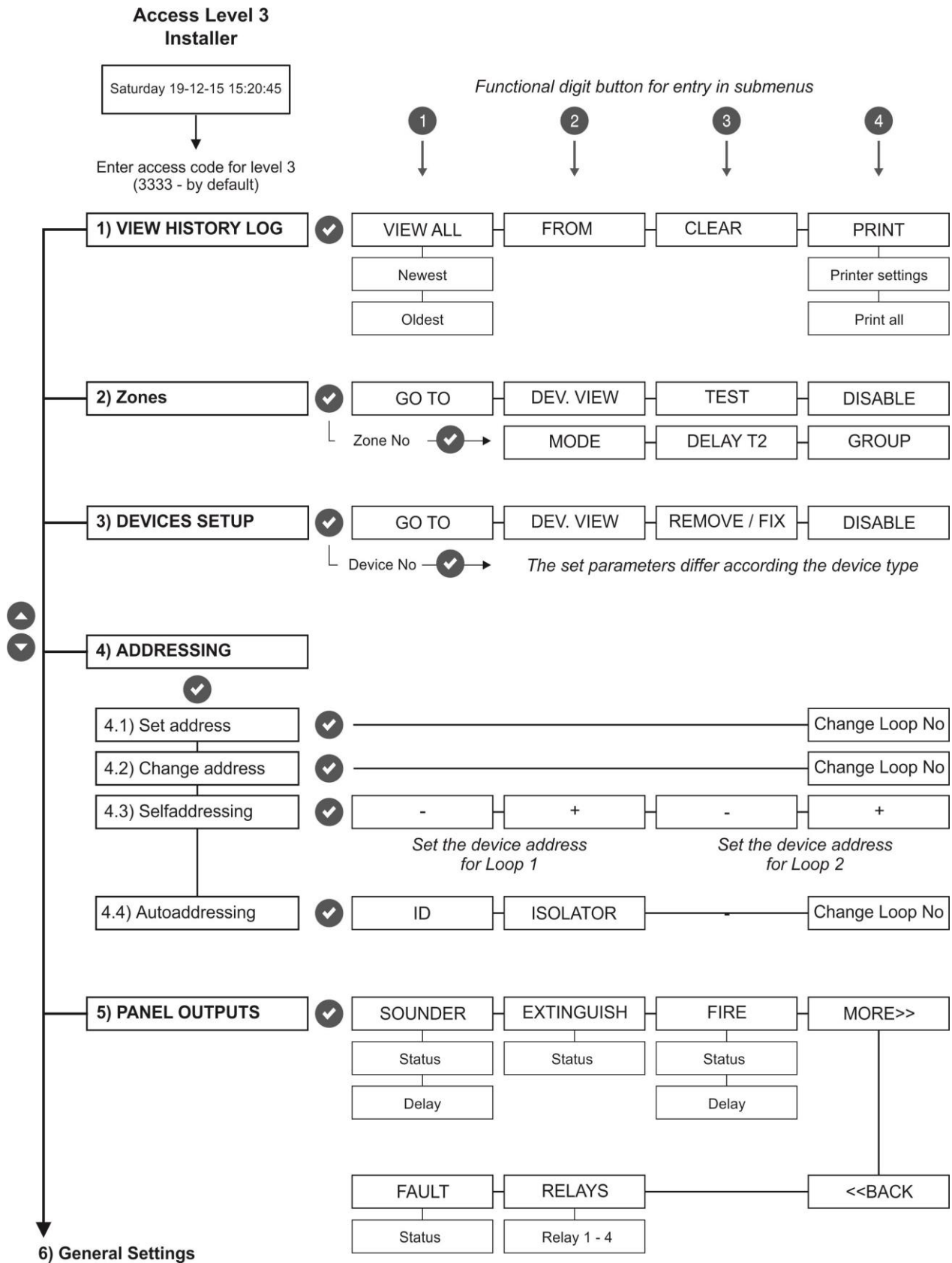

Tree structure of the menus – continue.

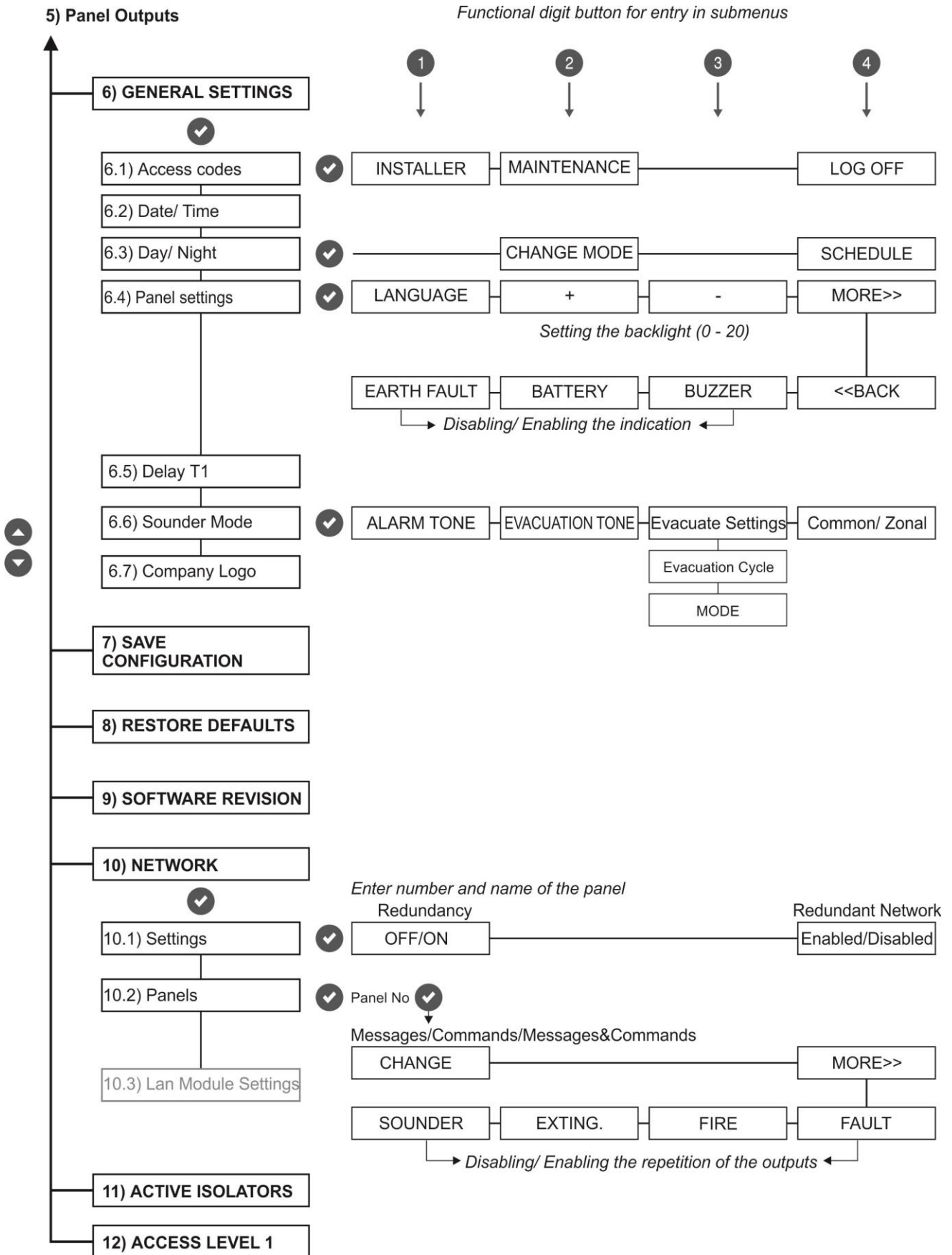



Teletek

electronics

www.teletek-electronics.com

Address: Bulgaria, 1407 Sofia, 14A Srebarna Str.
Tel.: +359 2 9694 800, Fax: +359 2 962 52 13
e-mail: info@teletek-electronics.bg