



INTELLIGENT REFLECTIVE BEAM DETECTOR INSTALLATION GUIDE[®]

Part no 55000-268 (5-50 metres)
55000-273 (50-100 metres)

INTELLIGENT REFLECTIVE BEAM DETECTOR

GENERAL INFORMATION

Description of the reflective beam detector	4
How does a beam detector work?	4
Automatic reset	4
Drift compensation	4

SYSTEM DESIGN

Positioning reflective beam detectors	5
Spacing	5
Height	6
Pitched roofs and sloping ceilings	6
How many reflective beam detectors can be connected to a loop?	7

INSTALLING BEAM DETECTORS

General	7
Setting the obscuration level	7
Setting the address	9
Fitting the reflective beam detector	10

TARGETING, ALIGNING AND COMMISSIONING THE REFLECTIVE BEAM DETECTOR

What is 'targeting' and 'aligning'?	11
Panning and tilting	11
Targeting explained	12
Targeting step by step	13
Alignment explained	14
Aligning step by step	14
Stabilisation and testing	16
Reflector test	16

COMMISSIONING

Analogue values	17
Alarm test	18

PROTOCOL DATA AND FAULT INDICATION

Input/Output bits	19
Type Code	19
LED fault indication	19

TROUBLESHOOTING

Fault finding	20
Spare parts	21
Technical Data	21

Read this installation guide because...



beam detectors are different from point detectors



beam detectors need to be aligned, not just installed



all engineers need to understand the alignment process



by following the advice in this guide you will avoid problems and repeated site visits

Read the guide through once in order to understand the steps needed to install and align correctly. Keep the guide handy to refer to during installation. If you need further advice or help phone, fax or email the Technical Sales Department at Apollo Fire Detectors.

Phone +44 (0) 23 9249 2412

Fax +44 (0) 23 9249 2754

Email techsales@apollo-fire.co.uk

GENERAL INFORMATION

Description of the reflective beam detector

The intelligent reflective beam detector is a single unit comprising a transmitter, a receiver and control electronics. In traditional beam detectors these three elements are supplied as separate units.

The transmitter projects a cone shaped beam of modulated infra-red light to a reflector (prisms). The reflector returns the beam to the detector where the receiver measures the amount of light received and converts it to a signal for processing in the control electronics.

The reflective beam detector is mounted so that the beam will project approximately 0.3m to 0.6m below and parallel to the roof or ceiling level (assuming that there are no obstructions) at distances up to 50 or 100m, depending on the model of detector. The maximum lateral detection range is 7.5m either side of the beam.

The reflective beam detector is available in two versions: one, part no 55000-268, is for use at distances up to 50m, and requires one reflector. Part no 55000-273 is for distances between 50m and 100m and requires four reflectors arranged as a square.

The reflective beam detector is loop-powered and incorporates a bi-directional short circuit isolator which switches the negative line in the event of a short circuit.

How does a beam detector work?

In normal operating conditions the strength of the light received is almost the same as the strength of the light emitted. When smoke is present in the beam path the light registered by the receiver is reduced by an amount dependent on the density of the smoke.

In the event of the smoke obscuring the light by a pre-selected minimum level for a period of 8 to 10 seconds a fire signal is generated. The

detection level can be set to 25%, 35% or 50% to suit different environments, examples of which are given in the table in the section 'Obscuration Level Setting' on page 7.

If the infra-red beam is obscured rapidly by 90% or more for approximately 10 seconds a fault condition is signalled. This condition normally indicates an object being placed in the beam path. It might also indicate loss of the reflector.

Automatic reset

The reflective beam detector automatically resets once an alarm or fault condition is no longer present. A normal status value is returned after 30 seconds following an alarm and 3 seconds following a fault.

Drift compensation

Over a period of time the light registered by the receiver might be reduced by factors such as dirt building up on the lenses of the detector.

The intelligent reflective beam detector compensates for this automatically in order to reduce the likelihood of nuisance alarms. At the limit of compensation the beam detector transmits a fault signal. In the event of a fire being detected when the beam detector has reached its compensation limit, the fire signal will override the fault signal.

Ensure that the design and installation is in accordance with the relevant national or local fire protection standard or installation code of practice

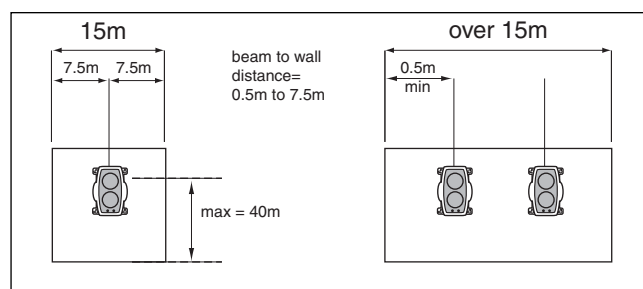

Fig 1 Positioning detectors under flat ceilings—examples of two building widths

SYSTEM DESIGN

Positioning reflective beam detectors

The intelligent reflective beam detector must be positioned correctly to minimise the detection time. The detection time depends on

- the location of the beam detector within the protected area*
- the volume of smoke produced*
- the construction of the roof*
- the ventilation arrangements*

When deciding where to install the beam detector and the reflector, you need to think of the construction of the surface you are fitting it to and to possible changes as a result, for example, of changing seasons. These surfaces must be solid and should not be subject to movement.

Particular areas where beam detectors should not be fitted include:

- *spaces where the detector is subject to very high levels of ambient light in normal conditions*
- *areas where excessive amounts of dust, smoke or water vapour are present as part of the normal environment*
- *areas where temperature changes rapidly*
- *surfaces subject to vibration or movement, such as cladding or purlins*
- *buildings in which it is not possible to mount the beam detector rigidly or align it correctly*

Spacing

The maximum spacing between the axes of adjacent beam detectors is typically 15m for satisfactory detection under flat ceilings, providing a maximum total area coverage of 1500 square metres (15m x 100m).

The minimum spacing between the axes of adjacent detectors is expressed by the following equation:

$$S \geq L \times 0.0875$$

where S is the spacing and L is the distance between the detector and the reflector.

The following table is based on this equation.

Distance (m)	Minimum spacing between devices (m)
5	0.44
10	0.87
15	1.31
20	1.75
25	2.19
30	2.62
35	3.06
40	3.50
45	3.94
50	4.37
55	4.81
60	5.25
65	5.69
70	6.12
75	6.56
80	7.00
85	7.44
90	7.87
95	8.31
100	8.75

Table 1 Minimum spacing between detectors

Ensure that spacing complies with the locally applicable code or standard.

Height

The maximum recommended installation height is generally 25m (some local standards or codes of practice might allow more under certain circumstances) and the distance between the beam and the ceiling should be within 0.3m and 0.6m. No more than 3m of the beam path (measured from the centre of the beam) should be within 500mm of any wall or partitions.

If detectors are installed at a distance of more than 600mm below ceiling level in order to provide supplementary detection of smoke in a building with a high ceiling, the installed height of detectors should be in accordance with the local code.

Pitched roofs and sloping ceilings

In buildings with pitched roofs or ceilings the maximum distance either side of the beam *in the apex only* may be increased by 1% for each degree of ceiling pitch up to a maximum of 25% (**Fig 2**).

Example: Roof pitch = 20°
Span of beam = 15m
 $15\text{m} + (15 \times 20\%) = 18\text{m}$

There must be a clear line of sight between the beam detector and reflector at all times. If there is any doubt about the correct mounting of detectors in a particular installation, the position may be determined by smoke tests.

Reflections from objects other than the prism reflectors may cause false alarms. Observe the rules on minimum spacing as given on page 5. All installations must conform to locally applicable standards and codes of practice.

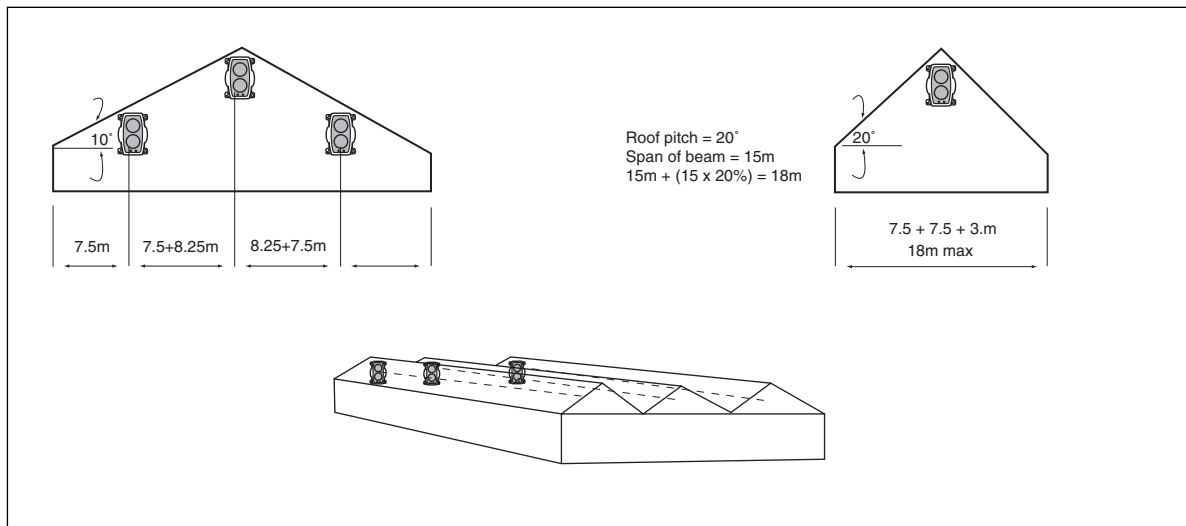

Fig 2 Positioning detectors under different types of sloped or pitched roofs

How many reflective beam detectors can be connected to a loop?

Although the reflective beam detector is loop powered, the total current drawn is considerably higher than a standard point detector. For this reason care must be taken when designing an analogue loop, bearing in mind the effects of voltage drop—a consequence of loop cable resistance, device loading and fire control panel specification.

Each reflective beam detector draws approximately 9mA from the analogue addressable loop and, unless proven by calculation*, it is recommended that *not more than ten beam detectors be powered from each loop.*

The reflective beam detector is fitted with a negative bi-directional short circuit isolator. For details of these please refer to Apollo PIN sheet PP2090.

**Depending upon the type of panel used, the resistance of cable and the total loop load, it may be possible to install in excess of 10 beam detectors on a single analogue addressable loop. A mathematical calculation to assess the worst case loop voltage drop should be performed prior to installation in order to prove the intended design. A loop voltage drop calculation program, known as 'Loop Calculator', has been developed by Apollo for use by system designers and is available as a free download from the Apollo website (www.apollo-fire.co.uk).*

INSTALLING BEAM DETECTORS

General

Position the beam detector to give good access for alignment and servicing.

Set sensitivity (obscuration level) and address before making electrical connections. Route cables away from other electrical cables and switchgear.

Switch reflective beam detectors to 'operating mode' (mode switch on the back of the detector) *before they are connected to the loop* to avoid excessive current draw on the loop.

Setting the obscuration level

Set the beam detector to one of the three obscuration levels shown in **Table 2** below. This is done with DIL switches 3 and 4 on the back of the detector (**Fig 3**).

To alter the obscuration level while power is applied change the beam detector to 'alignment mode' *before* altering the DIL switch setting. Change it back to 'operating mode' afterwards.

Obscuration level in %	Typical application	DIL switch segments			
		1	2	3	4
25	Offices, small premises, non-smoking clean areas, eg, museums, theatres	X	X	ON	OFF
35 (Default setting)	Factories, warehouses	X	X	OFF	ON
50	Hostile environments only, eg, mills, foundries	X	X	OFF	OFF
12 Do not use.	Possible future requirement.	X	X	ON	ON

Table 2 Obscuration levels

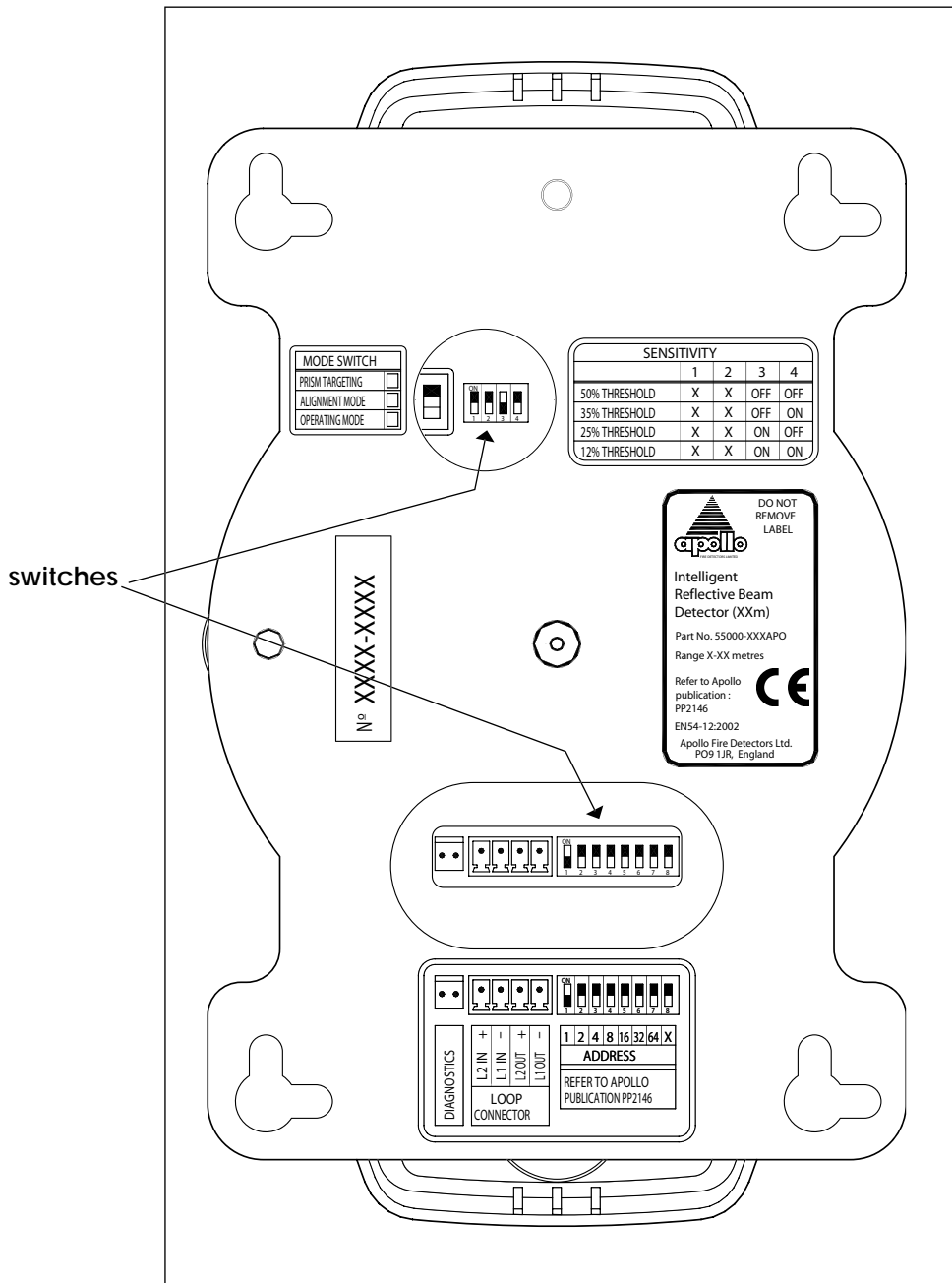

Fig 3 Rear view of intelligent reflective beam detector

Setting the address

The address of the beam detector is set using the DIL switch. The first seven segments of the switch are set to '0' or '1' using a small screwdriver or similar tool. The eighth segment is not used.

A complete list of address settings is shown below.

Example: Address 90 = 0 1 0 1 1 0 1

0

■ = Switch Position

1

Address									
1		26		51		76		101	
2		27		52		77		102	
3		28		53		78		103	
4		29		54		79		104	
5		30		55		80		105	
6		31		56		81		106	
7		32		57		82		107	
8		33		58		83		108	
9		34		59		84		109	
10		35		60		85		110	
11		36		61		86		111	
12		37		62		87		112	
13		38		63		88		113	
14		39		64		89		114	
15		40		65		90		115	
16		41		66		91		116	
17		42		67		92		117	
18		43		68		93		118	
19		44		69		94		119	
20		45		70		95		120	
21		46		71		96		121	
22		47		72		97		122	
23		48		73		98		123	
24		49		74		99		124	
25		50		75		100		125	
								126	

Table 3 DIL switch address settings

Fitting the reflective beam detector

Remove the detector housing before installation to prevent it becoming dislodged during the installation process.

Position the beam and reflectors on solid structures at between 0.3 and 0.6 metres below ceiling level. The correct number of reflectors (prisms) should be mounted directly opposite to and facing the beam detector. **Do not install reflectors on glass or other reflecting surfaces.**

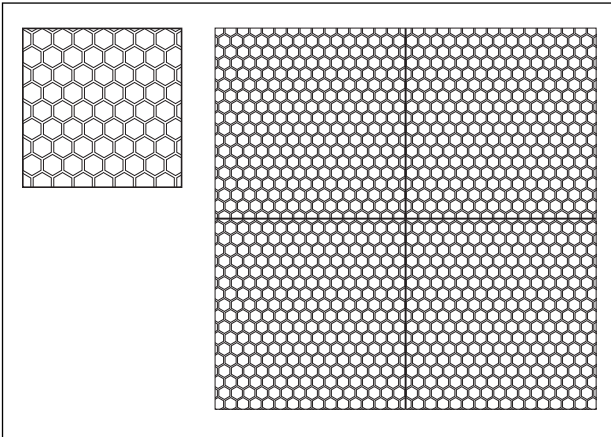

Fig 4 Reflectors for 50m reflective beam detector (left) and 100m detector

Ensure that there is a clear line of sight to the detector, taking care that no moving objects i.e. doors, mechanical lifting equipment etc, will interfere with the beam path.

Using the template provided mark the 4 fixing points on the structure and drill holes. The rear mounting plate of the beam detector assembly has 4 keyhole apertures to allow easy installation onto the 4 fixing points.

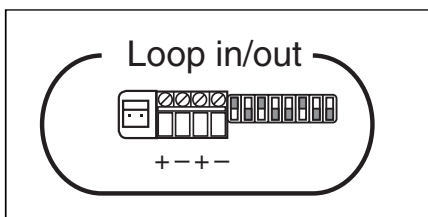

Fig 5 Loop connection diagram

Connect the loop wiring to the terminal block at the back of the beam detector (**Fig 5**). The small 2-pin connector on the left is not used. The beam detector is polarity sensitive and will operate only if wired correctly.

Secure the beam detector assembly to the fixing points and replace the housing.

TARGETING, ALIGNING AND COMMISSIONING THE REFLECTIVE BEAM DETECTOR

What is 'targeting' and 'aligning'?

The reflective beam detector will work only if the beam of light hits the reflector and returns to the receiver. The best possible result is achieved if the centre of the beam hits the centre of the reflector.

In order to achieve this result the beam detector is adjusted in two stages called 'targeting' and 'aligning'.

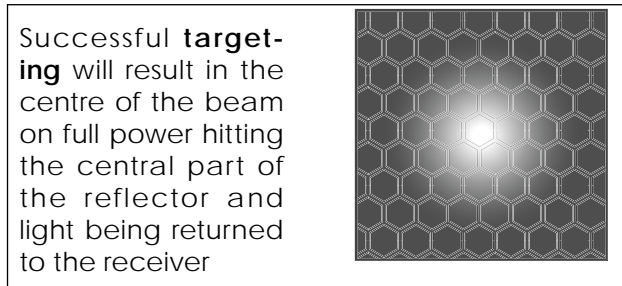

Fig 6 Targeting principle

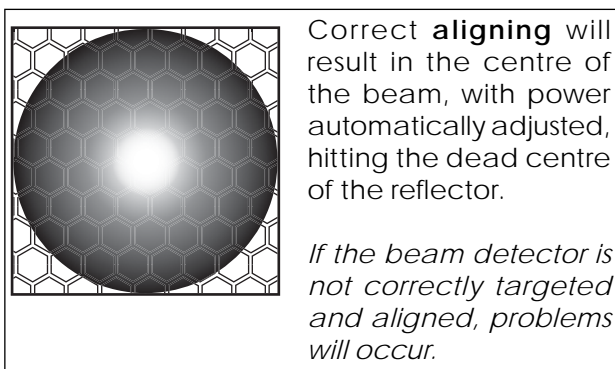

Fig 7 Aligning principle

Panning and tilting

To carry out the targeting and aligning process the reflective beam detector is *panned* (moved on its vertical axis) and *tilted* (moved on its horizontal axis). Two thumbwheels are provided to carry out these actions (*Fig 8*)

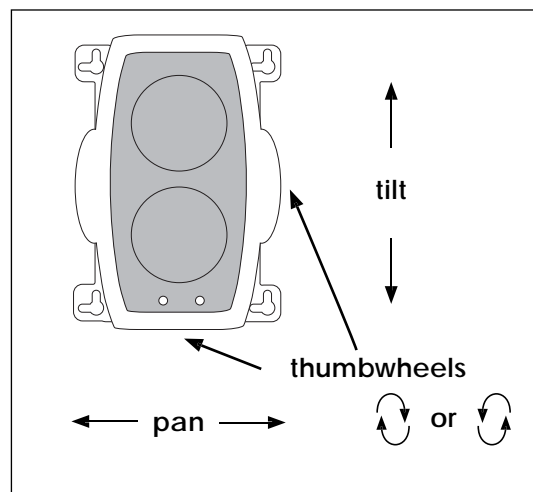

Fig 8 Panning and tilting the detector

Targeting explained

When the beam detector is set to 'targeting' it is automatically switched to full power. The purpose of targeting is to adjust the detector by panning and tilting until the beam shines on the reflector which then reflects it back.

Progress in targeting is indicated by two LEDs:

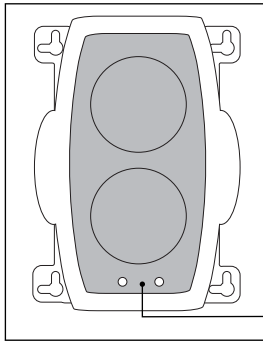

Fig 9a

no LED illuminated if beam hits outer part of the reflector or no part of the reflector

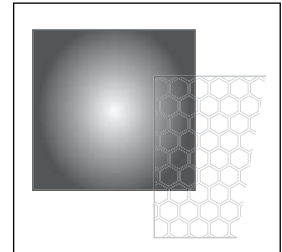

Fig 9b

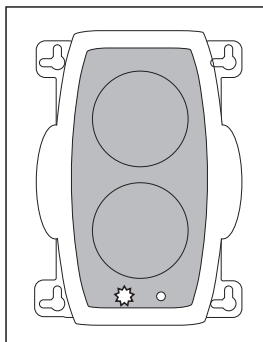

Fig 10a

red LED flashes if the centre of the beam falls in the area shown as a light ring in **Fig 10b**. The nearer the centre the quicker the flash rate.

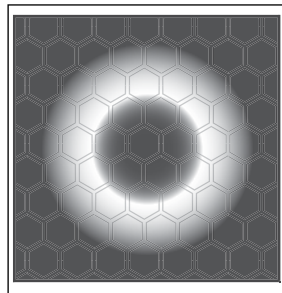

Fig 10b

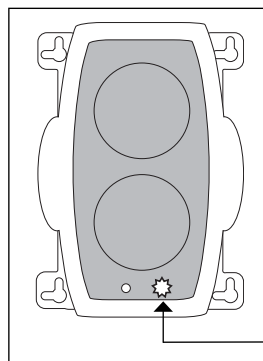

Fig 11a

the amber LED flashes at a constant rate when the centre of the beam hits the area shown in solid white in **Fig 11b**. Movement of the beam away from the centre to the boundaries of the dark area will cause the red LED to flash again.

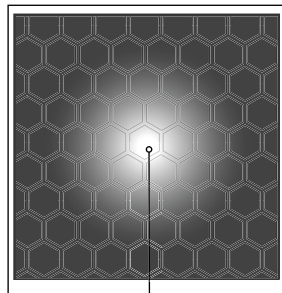

Fig 11b

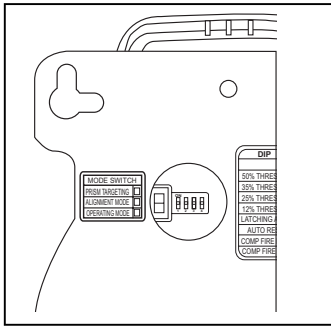

Fig 12 Mode switch

Targeting step by step

1. Switch on the beam detector. Push the mode switch (*Fig 12*) up to 'prism targeting mode'.
2. Pan and tilt the beam detector, by turning the thumbwheels, until the centre of the beam hits the part of the reflector shown in *Fig 10b*, causing the red LED to flash. It does not matter which way you move the detector. If moving in one direction does not cause the red LED to flash, move the other way.

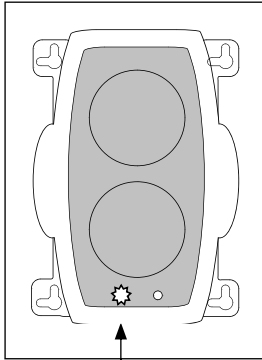

Fig 13

3. When the red LED flashes, select *either* pan *or* tilt (it does not matter which you do first) and continue adjusting the detector until the red flash reaches its maximum. Continue the adjustment until the red LED goes out and the amber LED starts to flash.

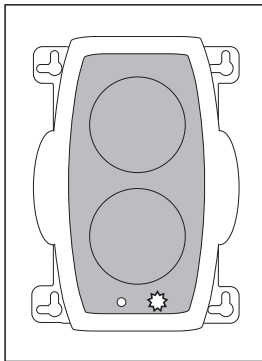

Fig 14

4. When the amber LED starts to flash keep turning the thumbwheel and start counting the number of steps.
5. Stop turning the thumbwheel when the amber LED goes out and the red LED starts flashing.
6. Turn the thumbwheel back half the number of steps counted. The amber LED should still be flashing.
7. Move the other thumbwheel until the amber LED has just gone out and the red LED is at maximum flash. Again, it does not matter which way you turn first.
8. At this point reverse the movement and, when the amber LED starts to flash, proceed as in steps 4 to 6.

*Note: At this point it is **essential** to test that the reflector and not another surface is reflecting the beam. Cover the reflector with a non-reflecting object and check that both LED indicators are off.*

Alignment explained

Alignment can only be carried out after successful targeting.

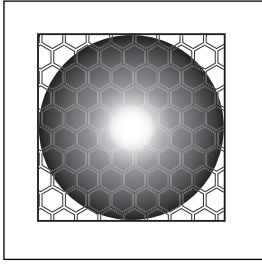

Fig 15

When the detector is switched to 'alignment' the power of the beam is adjusted automatically. The effect of panning or tilting is still indicated by the LEDs *but what they are indicating is different from when the detector is switched to 'targeting'*.

1. When the detector is switched to 'alignment' the LEDs flash to indicate that signal optimisation is in progress.
2. During the alignment procedure:
 - red LED flashes = beam is moving from the shaded area (see Fig 15) to the centre of the reflector
 - amber LED flashes = beam is moving away from the centre of the reflector

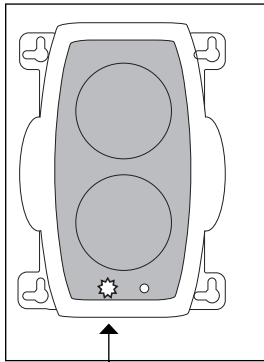

Fig 16

The objective is to align the detector such that the LEDs stop flashing and *any* adjustment (ie, any turn of the thumbwheels) will cause the amber LED to flash.

Aligning step by step

1. Set the mode switch to the middle position—'alignment'.

The detector will automatically optimise the infra-red beam strength and receiver sensitivity. Progress of optimisation is indicated by the LEDs on the front of the detector.

• Flashing red LED

The detector is receiving too high a signal and is attempting to reduce the infra-red power output. The LED should extinguish within 30 seconds*.

• Flashing amber LED

The detector is receiving too weak a signal and is attempting to increase the infra-red power output. The LED should extinguish within 30 seconds*.

• Flickering red/amber

This may occur when the detector is seeking the optimum setting for the infra-red power.

• LEDs off

The detector has optimised the infra-red power and receiver setting for the current orientation of the beam detector and reflector.

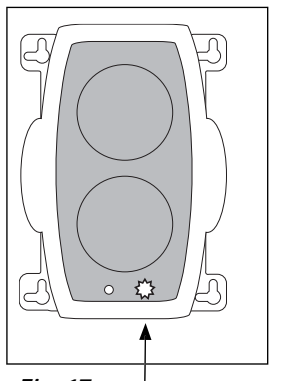

Fig 17

*If the LED does not go out in 30 seconds the installation should be checked before further alignment and calibration work is carried out. Repeat the targeting process described on page 13.

Leave the mode switch in 'alignment' for the next stage of the alignment procedure,

- The purpose of the second stage of alignment is to manually adjust the detector so as to align the centre of the beam as closely as possible with the centre of the reflector.

Turn one of the thumbwheels until one of the LEDs starts flashing. It does not matter whether you pan or tilt first or which way you turn the thumbwheel (*Figs 18 to 20* assume that panning is carried out first).

If turning one way does not cause either of the LEDs to flash, turn the thumbwheel the other way.

- If the amber LED illuminates, turn the thumbwheel the other way until either the red LED starts to flash (beam now close to centre) or neither LED flashes (beam is in the centre). Keep turning until the amber LED flashes then stop turning (*Fig 18*). Go to step 5.

- If the red LED flashes, wait until it stops and then turn a few steps more in the same direction. If the red LED flashes between steps, wait until it stops. Keep turning until the amber LED flashes then stop turning (*Fig 18*). Go to step 5.

- Turn the thumbwheel back, counting the number of turns as you go, until the amber LED starts flashing again and stop (*Fig 19*). If the red LED flashes at any point, wait until it goes out before going on.

- Change the direction of turn of the thumbwheel again and turn half the number of steps counted (*Fig 20*). If the red LED flashes at any point, wait until it goes out before going on.

- Now turn the other thumbwheel and carry out the steps described in points 3 to 6. *Figs 21 and 22* correspondingly show the tilting movement.

- At the end of the panning and tilting alignment procedures the centre of the beam should be projected onto the centre of the reflector, as shown in *Fig 23*. The LEDs will not be illuminated.

The reflective beam detector is now aligned and ready for final checks.

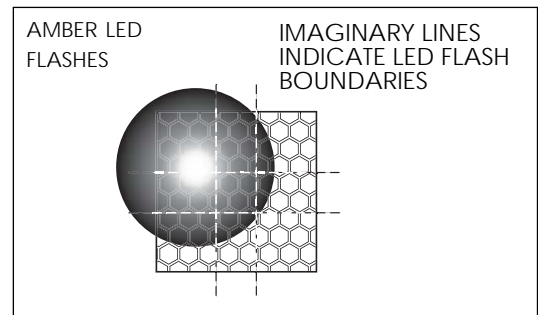

Fig 18

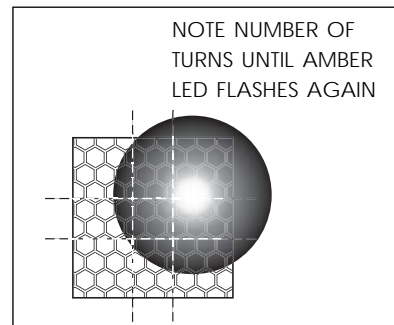

Fig 19

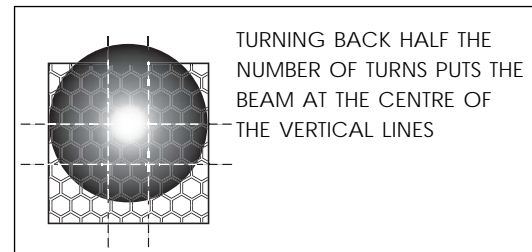

Fig 20 no LED flashes

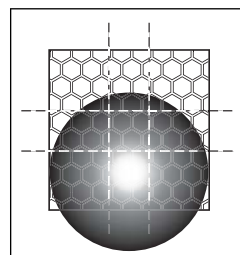

Fig 21

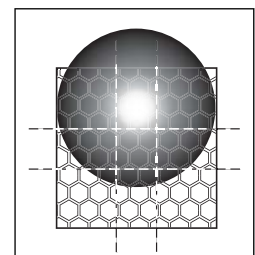

Fig 22

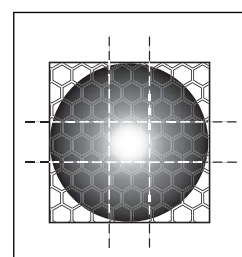

Fig 23 Detector aligned

Stabilisation and testing

The detector stabilises automatically but it is necessary to check the area which is being protected in order to make quite sure that the beam is being reflected only by the reflector and not by other material.

1. Remove all material that might reflect light. Light can be reflected not only by obvious sources, such as metal surfaces, glass or computer screens but also by paper, partitioning painted in pastel shades or even clothing—white shirts being a typical example.
2. Push the mode switch (*Fig 12* on page 13) down to Operating Mode.

When the detector has been switched to Operating Mode it performs an internal calibration check. The amber LED may flash for up to 60 seconds. When it goes out, perform the reflector test.

If the detector fails to calibrate the amber LED will flash after 60 seconds. Please refer to 'Troubleshooting' on page 20 if this should happen.

Reflector test

Cover the reflector completely with non-reflective material. After 15 seconds or sooner the amber LED of the beam detector will flash. Uncover the reflector.

If the amber LED does not flash, light is being reflected by an object other than the reflector. Repeat the targeting and aligning procedures in full.

Once the reflector test has been carried out successfully, the targeting and aligning procedures have been completed.

COMMISSIONING

Analogue values

The beam detector returns a pre-set analogue value corresponding to its status. These values are defined in *Table 4* below.

Analogue value	Significance
0	Microprocessor fault
1	Sensor fault
2	Prism (reflector) targeting mode
3	Alignment mode
4	General fault warning
5	'Signal High' fault
6	Contamination compensation limit reached
20	Alignment drift negative
25	Detector normal
30	Alignment drift positive
32	Contamination compensation level low (40%)
33	Contamination compensation level medium (60%)
34	Contamination compensation level high (80%)
45-54	Pre-Alarm values (see <i>Table 5</i> below)
64	Alarm

Table 4

The beam detector may return a pre-alarm value before a full alarm condition occurs. The analogue value depends on the smoke density and the set obscuration level (described on page 7) as shown in *Table 5*.

Analogue value returned	Actual obscuration at set obscuration level of		
	25%	35%	50%
45	16	23	33
46	16	26	34
47	17	27	35
48	18	28	36
49	19	29	38
50	20	30	40
51	21	31	42
52	22	32	44
53	23	33	46
54	24	34	48

Table 5 Percentage of obscuration indicated by pre-alarm

Alarm test

A test filter with a gradient from 0% to 100% black is supplied to carry out functional tests of the reflective beam detector.

Select the obscuration mark on the test filter (**Fig 24**) that corresponds to the obscuration set as described in page 7.

Place the filter over the receiver (upper lens) of the beam detector at the selected obscuration threshold, taking care not to cover the transmitter optics (lower lens).

The beam should change to the alarm condition within 10 seconds and the red LED should illuminate.* Check that the alarm condition is registered correctly at the control panel. Remove the test filter and wait at least 30 seconds before resetting the control panel. The red LED should extinguish within 30 seconds of the reset command.

**(Note: the red LED is controlled by the fire control panel).*

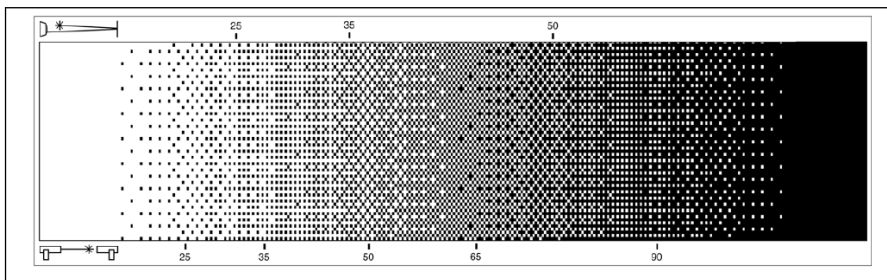

Fig 24 Test filter with obscuration levels indicated

PROTOCOL DATA AND FAULT INDICATION

Input/Output bits

The reflective beam detector responds to output bits from the protocol as follows:

*When **output bit 2** is set to **logic 1** on two or more consecutive pollings the red alarm LED is illuminated.*

*When **output bit 1** is set to **logic 1** on two or more consecutive pollings the beam detector carries out a self-test. If the test is successful, an analogue value of 64 is transmitted to the control panel. If a value less than 54 is transmitted, the self test has failed and the beam detector should be inspected (see Troubleshooting on page 20).*

Output bit 0 is not used.

Input bits 2, 1 and 0 reflect the status of the corresponding output bit.

Type Code

The type code of the reflective beam detector is 101 01 (bits 210 43).

LED fault indication

A fault is indicated by the amber LED flashing once per second.

If the drift compensation function has reached its limit the amber LED flashes once every 2 seconds. The detector will continue to function but maintenance procedures should be carried out at the earliest opportunity.

TROUBLESHOOTING

Before investigating individual beam detectors for faults, it is very important to check that the *system* wiring is fault free. Many fault conditions are the result of simple wiring errors. Earth faults on a data loop or any ancillary zone wiring may cause communication errors.

Please also refer to *Table 4* on page 17 for information on diagnostics that may be supplied by the beam detector.

Fault finding

Fault	Possible Cause	Action
Device not recognised	Type code incompatibility	Contact control panel manufacturer to check compatibility
Unable to obtain amber flashing alignment LED	No power to detector	Check wiring
Unable to obtain red flashing alignment LED	No power to detector	Check wiring
Amber flashing LED in operating mode	Beam out of alignment	Align beam
Alarm condition without fire	Beam partially obscured	Check beam line of sight
	Transmitter/receiver contaminated	Clean lenses and/or reflectors
	Environmental conditions	Check for symptoms such as condensation
Red LED illuminates after alignment	Panel software	Check analogue value at control panel, then reset

Table 6

Spare parts

If required, the following detector and reflector parts can be ordered separately.

Detector head assembly

Reflector (prism) for the 50m detector

Reflector (prism) for the 100m detector (= 4x 50m reflector)

Test filter

Technical Data

Part no 55000-268	5 to 50 metres (detector to reflector)
Part no 55000-273	50 to 100 metres (detector to reflector)
Supply Voltage	17–28V DC (plus protocol)
Supply Current	
Prism targeting mode	17mA
Alignment mode	17mA
Run mode (quiescent)	5mA
Alarm (LED illuminated)	9mA
Fault (LED illuminated)	5mA
Power down reset time	>5 seconds
Tolerance to beam misalignment (at 35% obscuration)	Detector $\pm 0.8^\circ$; prism $\pm 5.0^\circ$
Alarm thresholds	
25%	2.50dB
35%	3.74dB
50%	6.02dB
Optical Wavelength	880nm (infra red)
Operating temperature	-20°C to 55°C
Dimensions	
Width	130mm
Height	210mm
Depth	120mm
Weight	670 gm



Apollo Fire Detectors Limited, 36 Brookside Road, Havant, Hants, PO9 1JR, England
Tel +44 (0)23 9249 2412 Fax +44 (0)23 9249 2754
Email: techsales@apollo-fire.co.uk Website: www.apollo-fire.co.uk